

## **Storage Reserve Accumulation in Arabidopsis: Metabolic and Developmental Control of Seed Filling**

Authors: Baud, Sébastien, Dubreucq, Bertrand, Miquel, Martine, Rochat, Christine, and Lepiniec, Loïc

Source: The Arabidopsis Book, 2008(6)

Published By: The American Society of Plant Biologists

URL: <https://doi.org/10.1199/tab.0113>

---

BioOne Complete ([complete.BioOne.org](https://complete.BioOne.org)) is a full-text database of 200 subscribed and open-access titles in the biological, ecological, and environmental sciences published by nonprofit societies, associations, museums, institutions, and presses.

Your use of this PDF, the BioOne Complete website, and all posted and associated content indicates your acceptance of BioOne's Terms of Use, available at [www.bioone.org/terms-of-use](https://www.bioone.org/terms-of-use).

Usage of BioOne Complete content is strictly limited to personal, educational, and non - commercial use. Commercial inquiries or rights and permissions requests should be directed to the individual publisher as copyright holder.

---

BioOne sees sustainable scholarly publishing as an inherently collaborative enterprise connecting authors, nonprofit publishers, academic institutions, research libraries, and research funders in the common goal of maximizing access to critical research.

First published on July 24, 2008: e0113. doi: 10.1199/tab.0113

# Storage Reserve Accumulation in Arabidopsis: Metabolic and Developmental Control of Seed Filling

Sébastien Baud,<sup>1</sup> Bertrand Dubreucq, Martine Miquel, Christine Rochat and Loïc Lepiniec

Seed Biology Laboratory, Institut Jean-Pierre Bourgin (JJPB), UMR 204, INRA, AgroParisTech, 78000 Versailles, France.

<sup>1</sup> Address correspondence to e-mail: sbaud@versailles.inra.fr, fax +33-1-3083-3111

**In the life cycle of higher plants, seed development is a key process connecting two distinct sporophytic generations. Seed development can be divided into embryo morphogenesis and seed maturation. An essential metabolic function of maturing seeds is the deposition of storage compounds that are mobilised to fuel post-germinative seedling growth. Given the importance of seeds for food and animal feed and considering the tremendous interest in using seed storage products as sustainable industrial feedstocks to replace diminishing fossil reserves, understanding the metabolic and developmental control of seed filling constitutes a major focus of plant research. *Arabidopsis thaliana* is an oilseed species closely related to the agronomically important *Brassica* oilseed crops. The main storage compounds accumulated in seeds of *A. thaliana* consist of oil stored as triacylglycerols (TAGs) and seed storage proteins (SSPs). Extensive tools developed for the molecular dissection of *A. thaliana* development and metabolism together with analytical and cytological procedures adapted for very small seeds have led to a good description of the biochemical pathways producing storage compounds. In recent years, studies using these tools have shed new light on the intricate regulatory network controlling the seed maturation process. This network involves sugar and hormone signalling together with a set of developmentally regulated transcription factors. Although much remains to be elucidated, the framework of the regulatory system controlling seed filling is coming into focus.**

## INTRODUCTION

In seed plants, or spermatophytes, seed development is a key process linking two sporophytic generations that enables the life cycle to temporarily pause, allowing survival and dispersion (Bewley, 1997; Vicente-Carbajosa and Carbonero, 2005). A seed must package together all of the genetic material and nutrients required to allow successful propagation of the species. Seed formation is an intricate process that requires the coordinated growth of three tissues of distinct origins. The embryo and the endosperm are zygotic tissues, the development of which is initiated by the double fertilisation of the embryo sac. The embryo and the endosperm are protected by maternally-derived integuments, which constitute the seed coat. Seed development can be divided into embryo morphogenesis and maturation, the latter being characterised by storage compound accumulation, acquisition of tolerance to desiccation, growth arrest and the entry into a dormancy period broken upon germination (Harada, 1997). Beyond the diversity of size, shape and means of dispersal, one common element in plant seeds is the storage of reserve compounds that will be mobilised to fuel post-germinative seedling growth until seedling photosynthesis can be efficiently established. These components usually consist of starch, triacylglycerols (TAGs) and specialised storage proteins (SSPs), the relative proportions of which vary greatly depending on the species considered. Storage compounds contribute up to 90% of the seed dry weight and they also constitute the economic value of seeds in most field crops. Given the importance of seeds in the human and animal diet, cen-

turies of agricultural research have been directed at improving the qualitative and quantitative traits associated with seed components. More recently, some molecular genetic approaches have been developed to modify both the quality and quantity of seed products (Mazur et al., 1999). Today, there is a tremendous interest in understanding the genetic controls of seed development and metabolism.

In oleaginous species such as *Brassica napus* (rapeseed), one of the world's major oilseed crops, storage products consist of proteins and TAGs synthesised mainly in the embryo. As a Brassicaceae, *Arabidopsis thaliana* constitutes an excellent model system to investigate storage compound accumulation in oilseeds. The development of extensive tools for its genetics and molecular dissection together with the emergence of analytical procedures adapted to its very small seeds have led to major advances in isolating and characterising the factors involved in the metabolic and developmental control of seed filling.

## THE SEED MATURATION PROCESS IN *A. THALIANA*

### Seed Development

Seed development comprises two major phases: embryo morphogenesis (EM) and maturation (Figure 1A). In the model plant *A. thaliana*, several studies have been carried out to provide a complete description of this developmental process (Baud et al., 2002; Fait et al., 2006; Goldberg et al., 1994; Jenik et al., 2007).

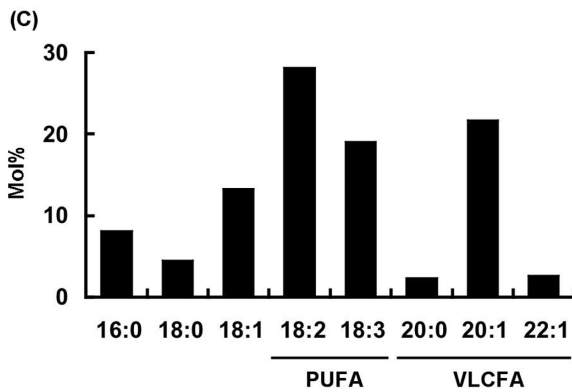
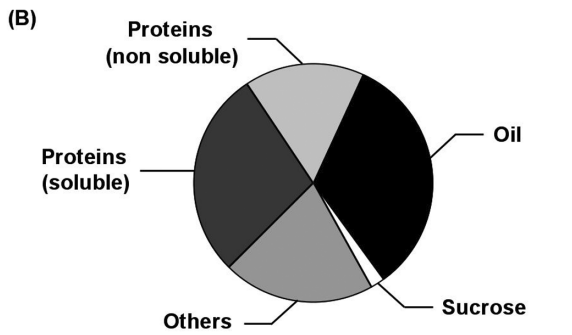
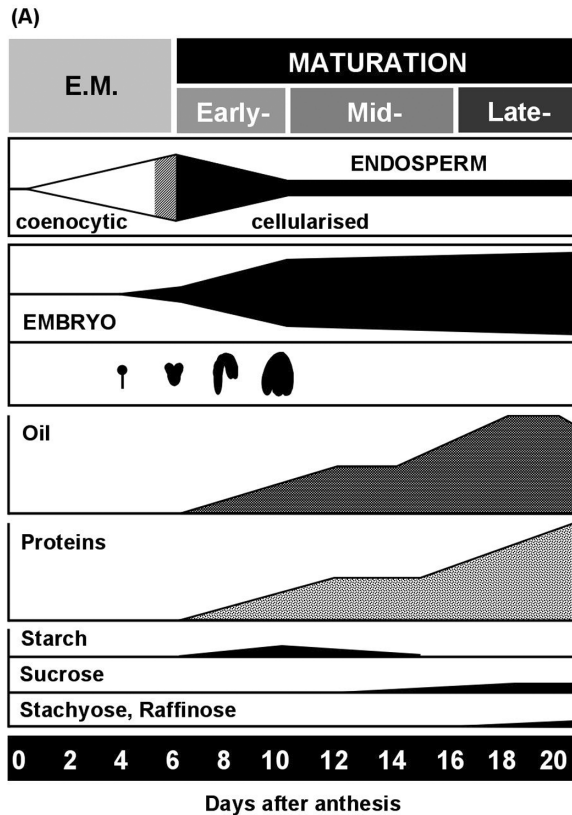

When plants are grown under a natural night and day regime, seed development takes roughly three weeks, the pollination event being referred to as day 0. Due to the autogamy of *A. thaliana*, this event cannot be directly observed. Yet, day 0 can be easily identified on the shoot since pollination is concomitant with the appearance of the petals that form a white dip at the extremity of the flower bud. Embryo morphogenesis is initiated by the double fertilisation of the embryo sac that gives rise to the zygote (2n) and endosperm (3n). The zygote firstly divides asymmetrically, the resulting apical and basal cells giving rise to the embryo and its suspensor, respectively. Through a series of cell divisions, the embryo progressively acquires the basic plan of the plant. At the end of EM, 6 days after pollination (DAP), torpedo-shaped embryos exhibit a polarity along an apical-basal axis. At the apical end of this axis, the shoot meristem is flanked by the cotyledons and is connected to the basal root meristem by the hypocotyl and root. Superimposed on this axis are radial and bilateral symmetries. Together with different cell fate patterning events, these symmetries lay the foundations for all post-embryonic development (Jenik et al., 2007; Jürgens, 2001). During EM, the triploid endosperm develops in two steps: a coenocytic stage followed by a cellularised and differentiated stage (Berger et al., 2006; Olsen, 2001). Seeds exhibit a white or pale yellow colour and their water content is high (> 80%).

The maturation phase is characterised by the accumulation of storage compounds and the acquisition of dormancy and desiccation tolerance (Goldberg et al., 1994). This process can be conveniently divided into three stages (Figure 1A). From 7 to 10 DAP early maturation corresponds to the embryo growth phase resulting in the formation of a fully developed embryo that fills the seed (Raz et al., 2001). During this phase, the ratio between the embryo volume and the endosperm volume is gradually reversed: the embryo goes through a period of cellular division and expansion whereas the endosperm is degraded and reduced to one cell layer surrounding the embryo. This rapid increase in embryo volume is accompanied by the accumulation of photosynthetic pigments, so that early maturing seeds turn green. Early maturing embryos exhibit elevated starch concentrations, while the synthesis and accumulation of storage lipids and proteins are initiated (Baud and Graham, 2006; Hills, 2007). During the second phase of the maturation process, ranging from 11 to 16 DAP, starch level drops regularly whereas high rates of fatty acid and protein synthesis can be measured in the embryo. These sustained biosynthetic activities result in a steady increase in seed dry weight throughout this phase (Baud et al., 2002). Finally, late maturation occurs between 17 and 20 DAP. Storage compound synthesis ends while the embryo becomes metabolically quiescent

**Figure 1.** Seeds of *Arabidopsis thaliana*

(A) Schematic overview of seed development in *A. thaliana* adapted from Baud et al. (2002). The relative volume of endosperm and embryo within the seed are presented throughout the seed developmental process. Embryos are represented at the globular, torpedo, early-bent cotyledon, and up-turned-U stages. A time course of carbohydrate and major storage compound (e.g. triacylglycerols and seed storage proteins) content is shown in parallel. E.M., embryo morphogenesis. (B) Composition of mature *A. thaliana* seeds (Wassilewskija accession). (C) Fatty acid composition of mature *A. thaliana* seeds (Wassilewskija accession). PUFA, polyunsaturated fatty acids; VLCFA, very long chain fatty acids.

and tolerant to desiccation. In late-maturing seeds, the water content declines sharply from 32% to less than 10%. In spite of this drastic loss of water, syntheses continue, with raffinose and stachyose being specifically stored during this late maturation stage (Baud et al., 2002; Fait et al., 2006). The accumulation of such oligosaccharides, together with the increase detected in both sucrose and trehalose levels, may participate to the protection of membranes and proteins, thus contributing to the acquisition of tolerance desiccation (Bailly et al., 2001; Hoekstra et al., 2001).

### Composition of Mature Dry Seeds

Seeds from the accessions Landsberg *erecta* (Ler) or Wasilewskija (Ws) usually weigh 20 µg when produced in a greenhouse, whereas seeds from the Cape Verde Islands (Cvi) accession weigh 35 µg (Alonso-Blanco et al., 1999; Baud et al., 2002). If Cvi seeds are almost twice as heavy as Ler seeds, the accession Cvi yields on average about 40% fewer seeds than Ler. Seed size is determined both by maternal and non-maternal genetic factors, and the final cell number and cell size of the seed coat and the zygotic tissues can exhibit significant variations (Alonso-Blanco et al., 1999). Some authors have proposed that a cross talk between maternal and zygotic controls may constitute the primary regulator of the coordinated control of seed size in *A. thaliana* (Garcia et al., 2005). *TRANSPARENT TESTA GLABRA2* (*TTG2*; At2g37260), *KIP RELATED PROTEIN2* (*KRP2*; At3g50630), and the *HAIKU* (*IKU*) genetic pathway that involves the *IKU1* locus, *IKU2* (At3g19700), and *MINISEED3* (At1g55600), participate into this complex regulatory network (Garcia et al., 2003; Luo et al., 2005). Likewise, *APETALA2* (At4g36920) has been shown to function outside the boundaries of flower meristem and flower organ development to participate in the regulation of seed mass (Jofuku et al., 2005; Ohto et al., 2005).

In dry seeds, cells of the embryo and endosperm are packed full of protein storage vacuoles (PSVs) and oil bodies. The SSPs and TAGs thus accumulated account for roughly 30-40% of the seed dry weight (DW) each (Figure 1B; Baud et al., 2002). PSVs are often localised in the centre of the embryonic cell, close to the nucleus, whereas oil bodies, which occupy about 60% of the cell volume in the cotyledons of mature embryos, are rather found at the periphery of the cell (Mansfield and Briarty, 1992). Two types of SSPs are stored in PSVs referred to as 2S albumins and 12S globulins (for a review, see Fujiwara et al., 2002). The TAGs stored in oil bodies consist of esters of glycerol and fatty acids (Figure 1C; Miquel and Browse, 1995). When analysing the seed composition of 360 *A. thaliana* accessions, the modal oil content is found to be 38% of DW, with most accessions studied lying within the range 33-43% (O'Neill et al., 2003). Despite coming from diverse geographical locations, seeds of all the ecotypes analysed so far contain identical fatty acids, but exhibit reproducible variations in the relative proportions of those fatty acid species (Millar and Kunst, 1999). For instance, very long chain fatty acid (VLCFA) content ranges from 13 to 21% of total fatty acids while polyunsaturated fatty acid (PUFA) content ranges from 53 to 66% of total fatty acids (O'Neill et al., 2003). The separation of mature Columbia-0 seeds into embryo and endosperm has revealed that fatty acids in the endosperm tissues compose approximately one-tenth of those present in whole seeds (Penfield et al., 2004). Interestingly, if all

the fatty acids detected in the embryo are also present in the endosperm, the latter contains proportionally high levels of 16:1 $\Delta^9$  (or 16:1n7, palmitoleic acid), 18:1 $\Delta^{11}$  (or 18:1n7, vaccenic acid), and 20:1 $\Delta^{13}$  (or 20:1n7, paullinic acid) long chain fatty acids (LCFAs), accounting for more than 50% of the total n7 monounsaturated fatty acid present in the whole seed. Around 20% of endosperm fatty acids are n7 monounsaturated compared with only 2% in the embryo (Penfield et al., 2004). Contrarily to SSPs or TAGs, oligosaccharides like sucrose, raffinose, and stachyose account for only 2% of the mature seed DW. Yet, variations in the content of those components can be observed among various accessions, with Cvi seeds storing very low quantities of oligosaccharides of the raffinose series for instance (Bentsink et al., 2000).

## SEED STRUCTURE AND NUTRIENT SUPPLY

### Post-phloem Transport

Seeds are mostly heterotrophic organs, dependent on nutrients supplied by the parent plant for their growth and development (Zhang et al., 2007). Nutrients are imported through the phloem, and nutrient loading of seeds is a spatially and temporally dynamic process (Patrick and Offler, 2001). The seed anatomy in *A. thaliana* is different from that described for well-characterised legumes and cereals (Weber et al., 2005). In *A. thaliana*, the unique vascular bundle terminates at the end of the funiculus. There is no vascular tissue within the seed and most of the nucellar cells have degenerated in the fully developed seed. The seed coat consists of five cell layers: the innermost endothelial layer, followed by two cell layers each of inner and outer integuments (Lepiniec et al., 2006). Two symplastic domains, corresponding to the outer and the inner integuments, have been identified (Stadler et al., 2005). The outer integument allows movement of unloaded nutrients and represents a symplastic extension of the funicular phloem. The transfer between the outer integument and the inner integument, between the inner integument and the endosperm, and between the endosperm and the embryo might be apoplastic (Kim and Zambryski, 2005). Three apoplastic borders may consequently separate the phloem from the maturing embryo; carrier-mediated transports may be required to transport nutrients across these borders. While the outer integument may be compared, to a certain extent, to the vascular compartment in the seed coat of grain legumes, the inner integument is speculated to function as the ground tissue of legume grains, which releases the nutrients from the testa (Stadler et al., 2005). During seed development, dominant sinks for nutrient loading thus shift from integuments early in development, to filial tissues during later stages of development. Released nutrients are mainly accumulated in endosperm during EM. Then, during early maturation, the endosperm functions as a nutrient source for the growing embryo (Hill et al., 2003). During EM, the embryo and its suspensor form a single symplast (Kim et al., 2005a; Stadler et al., 2005) and the suspensor is assumed to have a nutritive function for the young embryo (Yeung and Meinke, 1993). This function is most likely limited to the early steps of embryo development (globular stage) since the connectivity between suspensor and embryo stops with the specification of the hypophysis (triangular stage). Then, the suspensor begins to degenerate (heart stage). As the maturing

embryo develops, the functional aperture of plasmodesmata between embryonic cells is down regulated so that four subdomains of symplastic transport are formed within the embryo (torpedo stage): the shoot apex subdomain, the cotyledon subdomain, the hypocotyl subdomain, and the root subdomain (Kim et al., 2005a).

### Seed Transporters

Sucrose represents the major form in which photosynthetically assimilated carbon is transported in plants. Because of the absence of symplastic linkage between maternal and filial tissues in *A. thaliana*, sucrose must cross several apoplastic borders to reach filial tissues. At each of the apoplastic boundaries both export steps into the apoplastic space and import steps into the next symplastic isolated cell layer are required. The mechanisms involved in export processes are not well understood. Among the various transport mechanisms that can contribute to an efficient uptake on the import side of the apoplastic border, energy dependent, proton-symporting carrier proteins have been shown to play a role of the utmost importance (Patrick et al., 1995; Schmidt et al., 2007; Sauer, 2007). The complete sequencing of the *A. thaliana* genome revealed nine putative sucrose transporters. At least three of them are expressed in developing seeds. *AtSUC3* (At2g02860) exhibits a widespread expression pattern that includes the embryo suspensor and embryonic root tip; its implication in uptake of sucrose by the maturing embryo remains to be demonstrated (Meyer et al., 2004). *AtSUC5* (At1g71890), which is induced in the endosperm during EM and early maturation, plays an important but transient role in the nutrition of filial tissues during early seed development (Baud et al., 2005). The case of *AtSUC2* (At1g22710) is more ambiguous: although transcriptomic data have pointed out its up regulation in maturing seeds (Ruuska et al., 2002), neither its detailed expression pattern nor its function in maturing seeds has been elucidated so far.

Given the complexity of amino acid transport and the high number of putative transporters in *A. thaliana*, our understanding of amino acid supply to maturing seeds is still very partial. Within the amino acid transporter superfamily 1 (ATF1), two subfamilies, the amino acid permeases (AAPs) and lysine histidine transporter (LFTs), encode functional transporters with a broad substrate range. In the second superfamily, the amino acid-polyamine-choline (APC) superfamily, transporters of the cationic amino acid transporter-family (CATs) were characterised as more specific for cationic and neutral amino acids (Schmidt et al., 2007). To date, two members of the AAP subfamily are thought to be involved in amino acid supply to the developing seed. *AtAAP1* (At1g58360) is expressed during EM and early maturation in the filial tissues (Hirner et al., 1998). Likewise, *AtAAP8* (At1g10010) is induced in developing seeds (Okumoto et al., 2002) and plays a critical role for the uptake of amino acids like aspartate and glutamate during embryo morphogenesis and growth (Schmidt et al., 2007). Beyond AAPs, the peptide transporter *AtPTR2* (At2g02040) may participate in the supply of reduced organic nitrogen compounds to young developing seeds (Song et al., 1997).

Data concerning the transport and storage of minerals during the seed maturation process are even scarcer. Mineral deposits are located inside the PSVs of mature seeds, in inclusions called globoids (Gillespie et al., 2005). They are composed of phytin, a salt of phytic acid (myo-inositol-1,2,3,4,5,6-hexakisphosphate) and its

cations (mostly Mg, K, and Ca) (Lott et al., 1995; Otegui et al., 2002). In *A. thaliana*, the seed iron is also stored in globoids of the PSVs, predominantly in the provascular strands of the embryo (Kim et al., 2006; Lanquar et al., 2005). *AtOPT3* (At4g16370), a peptide transporter, and the vacuolar iron uptake transporter *VIT1* (At2g01770) have been shown to play a critical role in iron nutrition of developing seeds (Kim et al., 2006; Stacey et al., 2002; Stacey et al., 2007). The exact mechanism involved remains to be characterised. Finally, the *ATNRT2.7* (At5g14570) nitrate transporter was recently shown to control nitrate accumulation in the PSVs of late maturing seeds (Chopin et al., 2007). In dry seeds, N from nitrate represents less than one thousandth of seed nitrogen and may not be regarded as a storage form of nitrogen. However, the role of nitrate as a signalling molecule during germination may be important.

## METABOLIC FLUXES IN THE MATURING EMBRYO

### A Set of Complementary Tools Adapted to Investigate Seed Metabolism

The emergence of *A. thaliana* as a major plant model system together with the development of extensive tools for its genetic and molecular dissection has led to major advances in the understanding of many developmental and physiological processes, including seed development and maturation (Girke et al., 2000). The complete sequencing of the *A. thaliana* genome (Arabidopsis Genome Initiative, 2000) has provided considerable insights into the nature and number of proteins involved in the metabolic pathways required for storage compound synthesis. These data have been further improved by the careful annotation of genes related to seed metabolism by researchers who have knowledge of these biological processes (Beisson et al., 2003). The use of large-scale chemical mutagenesis experiments and the emergence of T-DNA mutant collections have then allowed to isolate and characterise new actors (enzymes, transcription factors) of the seed maturation process. The exploitation of natural variation for seed composition among a collection of seeds originating from a wide range of geographical locations throughout the world has proved highly valuable for elucidating the regulation of adaptive traits (O'Neill et al., 2003). Due to their very small size, seeds of *A. thaliana* have posed a technical challenge that has led to the emergence of experimental procedures adapted to this material. Sets of ESTs from developing seeds (White et al., 2000) and microarrays displaying seed-expressed genes (Girke et al., 2000; Buckhout and Thimm, 2003) have been produced. Sensitive and high throughput metabolite assays for the precursors of starch and fatty acid synthesis have been developed (Gibon et al., 2002). Probing *in vivo* metabolism by stable isotope labelling of storage lipids and proteins in developing embryos of *B. napus* has then allowed obtaining maps of the metabolic fluxes through central metabolism (Schwender and Ohlrogge, 2002; Schwender et al., 2004b). Finally, considering that the three tissues composing the seed are very different and should, if possible, be analysed separately (Hill et al., 2003), techniques like *in situ* hybridisation, immunolocalisation, and *in situ* histochemistry (Baud and Graham, 2006) have provided key elements to understand seed metabolism and physiology. However, high throughput procedures adapted to seed material are not yet available for these techniques.

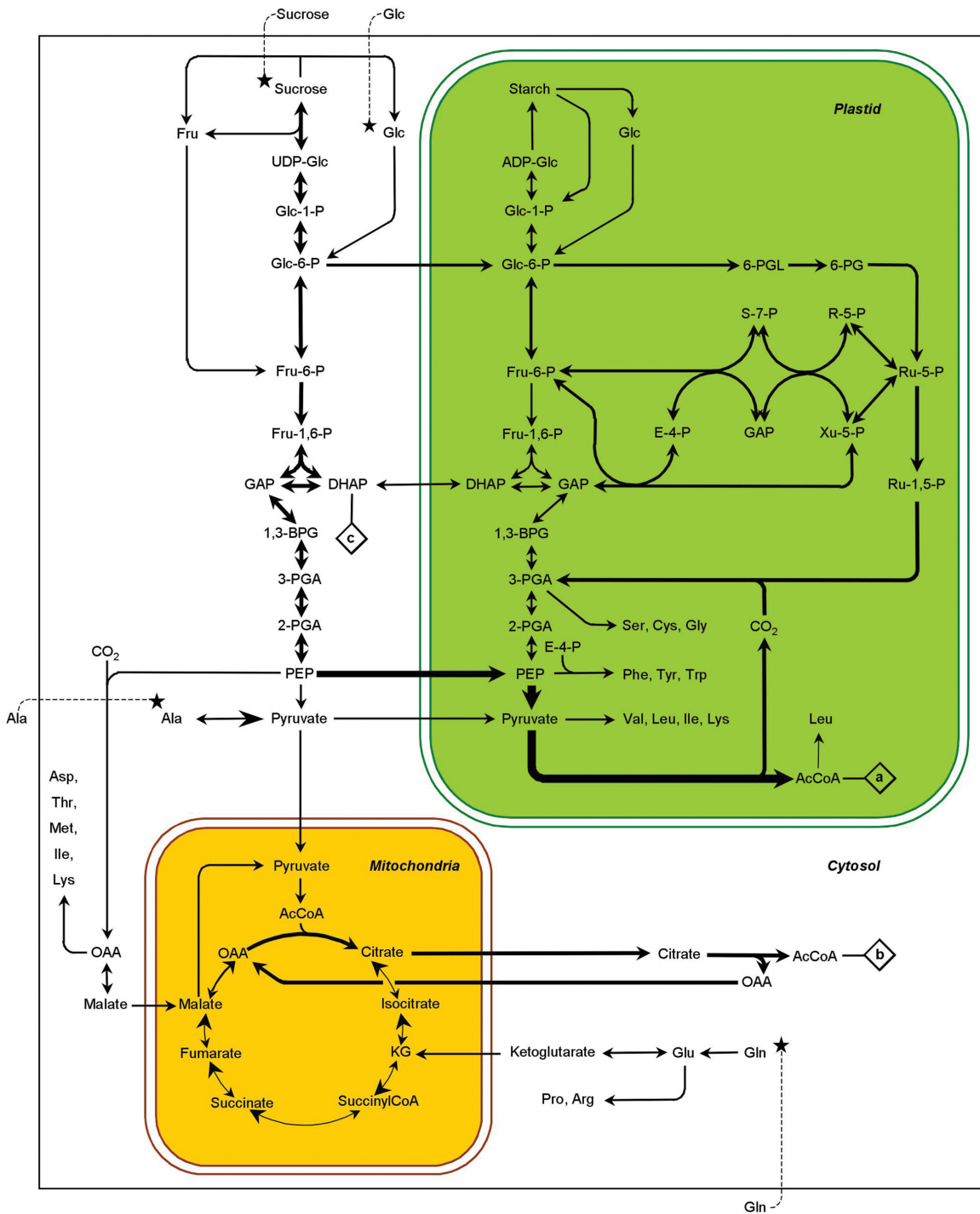

**Figure 2.** Simplified scheme of central metabolism in maturing embryos of *Arabidopsis thaliana*.

This scheme is adapted from White et al. (2000), Schwender et al. (2004), and Schwender et al. (2006). The arrow thicknesses are proportional to net fluxes of carbon, based on biochemical data and transcriptional profiling of maturing seeds. Black stars indicate metabolites that are directly imported from the apoplastic space. Letters in a diamond indicate metabolic links with pathways presented on figures 3 and 4. ADP-Glc, adenosine diphosphoglucose; AcCoA, acetyl-coenzyme A; 1,3-BPG, 1,3-bisphosphoglycerate; DHAP, dihydroxyacetone-3-phosphate; E-4-P, erythrose-4-phosphate; Fru, fructose; Fru-1,6-P, fructose-1,6-bisphosphate; Fru-6-P, fructose-6-phosphate; GAP, glyceraldehyde-3-phosphate; Glc, glucose; Glc-1-P, glucose-1-phosphate; Glc-6-P, glucose-6-phosphate; KG, alpha-ketoglutarate; OAA, oxaloacetate; 6-PG, 6-phosphogluconate; 6-PGL, 6-phosphogluconolactone; PEP, phosphoenolpyruvate; 2-PGA, 2-phosphoglycerate; 3-PGA, 3-phosphoglycerate; R-5-P, ribose-5-phosphate; Ru-1,5-P, ribulose-1,5-bisphosphate; Ru-5-P, ribulose-5-phosphate; S-7-P, sedoheptulose-7-phosphate; UDP-Glc, uridine diphosphoglucose; Xu-5-P, xylulose-5-phosphate.

### Primary Metabolism of Maturing Embryos

In *B. napus*, the main organic compounds furnished to the maturing embryos consist of sucrose, glucose, Gln, Glu, and Ala (Schwender and Ohlrogge, 2002; Schwender et al., 2006). In sink organs, incoming sucrose can be cleaved via two distinct pathways involving either invertase (EC 2.4.1.13) or sucrose synthase (SUS; EC 3.2.1.26). In several species, SUS activity is a marker for storage accumulation activity (Craig et al., 1999). Among the six members of the *AtSUS* gene family, two isoforms are strongly induced during early- (*SUS2*, At5g49190) or mid-maturation (*SUS3*; At4g02280) (Baud et al., 2004b). However, recent results demonstrate that this pair is not essential for seed filling (Bieniawska et al., 2007) and that the invertase pathway participates to the cleavage of incoming sucrose, at least in maturing embryos of *Brassica napus* (Schwender et al., 2003). Cleavage of sucrose generates a hexose-phosphate pool that fuels three distinct biochemical pathways (Figure 2): (i) the transient starch biosynthesis pathway in the plastids (see below), (ii) the oxidative pentose phosphate pathway (OPPP), and (iii) the cytosolic and plastidial glycolytic pathways. These hexose-phosphates are thought to be massively metabolised through the glycolytic pathway before utilisation for fatty acid synthesis. In oil seeds, maturing embryos do have a complete glycolytic pathway in the cytosol and in the plastids (Dennis and Miernyk, 1982; Kang and Rawsthorne, 1994). The extent to which both pathways are utilised in the conversion of carbohydrates into precursors of fatty acid biosynthesis is highly debated. Transcriptomic data suggest that a major route involves the cytosolic glycolytic pathway up to phosphoenolpyruvate (PEP) (Ruuska et al., 2002; White et al., 2000), this compound being imported into the plastid before subsequent conversion to pyruvate (Kubis et al., 2004). The essentially irreversible transphosphorylation from PEP and ADP to pyruvate and ATP is catalysed by pyruvate kinase (PK, EC 2.7.1.40) (Valentini et al., 2000). Among the 14 putative isoforms of PK present in the genome of *A. thaliana*, three genes encode subunits  $\alpha$  (*PKp- $\alpha$* , At3g22960),  $\beta$ 1 (*PKp- $\beta$ 1*, At5g52920), and  $\beta$ 2 (*PKp- $\beta$ 2*, At1g32440) of plastidic PK (PKp). The plastid enzyme prevalent in developing seeds likely has a subunit composition of  $4\alpha 4\beta$ 1, and the analysis of *pkp $\alpha$ -pkp $\beta$ 1* mutant seeds that appear to be severely depleted in oil (up to 60%) clearly establishes the importance of the plastid route in the conversion of PEP into precursors of fatty acid synthesis (Andre et al., 2007; Baud et al., 2007b). The subsequent oxidative decarboxylation of pyruvate to produce acetyl-CoA, CO<sub>2</sub>, and NADH is catalysed by the pyruvate dehydrogenase complex (PDC). The PDC complex is a large multi-enzyme structure composed of three primary component enzymes, pyruvate dehydrogenase (PDH or E1 component; EC 1.2.4.1), dihydrolipoamide acetyl-transferase (E2; EC 2.3.1.12), and dehydrolipoamide dehydrogenase (E3; EC 1.8.1.4) (Johnston et al., 1997). PDH is a heterodimer composed of  $\alpha$  and  $\beta$  subunits encoded by genes *E1 $\alpha$*  (At1g01090), *E1 $\beta$ 1* (At1g30120), and *E1 $\beta$ 2* (At2g34590), while E2 is a homotrimer and E3 a homodimer (Randall and Miernyk, 1990). Both *PTLPD1* (At3g16950) and *PTLPD2* (At4g16155) genes for the E3 component are induced in maturing seeds (Drea et al., 2001; Lutziger and Oliver, 2000). Disruption of *p1E2* (At3g25860), the gene for the E2 component causes an early embryo lethal phenotype (Lin et al., 2003). During the formation of acetyl-CoA by the PDC complex, one-third of the carbon of precursors for fatty acids is re-

leased as CO<sub>2</sub>, suggesting that without refixation, a substantial fraction of the carbon entering seeds of *B. napus* would be lost (Schwender and Ohlrogge, 2002). In green maturing embryos, ribulose 1,5-bisphosphate carboxylase/oxygenase (RuBisCO) is able to act without the Calvin cycle to refix this CO<sub>2</sub>, thus increasing the efficiency of carbon use in maturing embryos (Schwender et al., 2004a). This metabolic route involves the conversion of hexose phosphates to ribulose-1,5-bisphosphate (Ru-1,5-P) by the non-oxidative reactions of the OPPP together with phosphoribulokinase (EC 2.7.1.19), and the subsequent conversion of Ru-1,5-P and CO<sub>2</sub> to 3-phosphoglycerate (3-PGA) by RuBisCO. Although increasing activities of phosphoenolpyruvate carboxylase (PEPc, EC 4.1.1.31) can be monitored in maturing embryos of *Brassica campestris* and *Brassica napus* (Junker et al., 2007; King et al., 1998; Sebei et al., 2006), refixation of CO<sub>2</sub> into oxaloacetate, and then into seed proteins is limited in green developing embryos (Schwender et al., 2004a). In maturing embryos of *Brassica napus*, mitochondrial carbon metabolism is largely “unconventional” (Schwender et al., 2006). Flux around the TCA cycle is absent and mitochondrial substrate oxidation contributes little to ATP production. Most mitochondrial metabolic flux is devoted to cytosolic fatty acid elongation, since essentially all the citrate formed in the mitochondria is exported and used for the production of cytosolic acetyl-CoA by ATP citrate lyase. Most of the oxaloacetate produced is committed to the synthesis of Asp and amino acids derived from it. Maturing embryos import nitrogen as amino acids (mainly Gln and Ala) used directly for SSPs synthesis but also for the synthesis of other amino acids via transamination/deamination reactions (Schwender et al., 2006). As a consequence,  $\alpha$ -ketoglutarate (KG) derives from Gln and not from anaplerotic flux from PEP via oxaloacetate (OAA).

### Light, Photosynthesis, Oxygen, and Seed Maturation

Fatty acid synthesis, which occurs in the plastids, not only depends on the supply of precursors but also requires large amounts of ATP and reductant. The OPPP is regarded as one of the major sources of nicotinamide adenine dinucleotide phosphate (NADPH) in non-photosynthetic tissues as well as in photosynthetic tissues experiencing darkness (Neuhaus and Emes, 2000). The two dehydrogenases in the OPPP, namely glucose-6-phosphate dehydrogenase (G6PDH, EC 1.1.1.49) and 6-phosphogluconate dehydrogenase (6PGDH, EC 1.1.1.44) use NADP<sup>+</sup> as a cofactor and generate two moles of NADPH during the conversion of glucose-6-phosphate to ribulose-5-phosphate (Wakao and Benning, 2005). However, the study of carbon fluxes in developing *B. napus* embryos cultured *in vitro* has established that the reducing power produced by the OPPP accounts for at most 44% of the NADPH and 22% of total reductant needed for fatty acid synthesis (Schwender et al., 2003). Considering the limited role for OPPP in NADPH production and the absence of respiratory TCA flux in embryonic tissues exhibiting high ATP demands, other sources are required to supply these needs of reductant and ATP in oilseeds. An alternative for NADPH and ATP production within plastids of green seeds is photosynthesis, provided that enough light is available. Recent studies have confirmed the importance of light passing through the silique wall on green oilseed metabolism (Goffman et al., 2005; Ruuska et al., 2004; Schwender et al., 2004a). In *B.*

*napus*, only 20-30% of incident light penetrate the silique wall (Eastmond et al., 1996; King et al., 1998) and the pigment composition of developing seeds reflects shade adaptation (Ruuska et al., 2004). Yet, seed photosynthesis contributions quantitatively match the major demand for NADPH and ATP for fatty acid synthesis and other plastid metabolism, and increasing light can improve significantly the efficiency of oil synthesis in developing embryos (Goffman et al., 2005). Seeds from higher light tend to be bigger and to exhibit an increased C:N ratio, light preferentially enhancing oil over protein storage (Li et al., 2006). If green oilseeds maximise oil synthesis during light periods, those syntheses appear to be drastically reduced during the night, thus avoiding large losses of carbon (Goffman et al., 2005; King et al., 1998).

Several reports document an inhibition of embryo growth and seed storage compound accumulation when plants are grown at low external oxygen (Kuang et al., 1998; Porterfield et al., 1999). Even when plants are cultured at ambient O<sub>2</sub> levels, recent studies on *B. napus* suggest that internal oxygen concentrations can limit metabolism in seeds placed under low or mild light (Vigeolas et al., 2003). Thus, green oilseed embryos can experience hypoxia, as described in developing legumes (Rolletschek et al., 2002). Low O<sub>2</sub> is accompanied by a decrease in the energy state within seeds and decreased metabolic fluxes to storage TAG biosynthesis. On the contrary, under high light, photosystem activity may release sufficient O<sub>2</sub> to prevent hypoxia, so that oilseed metabolism is not restricted by low O<sub>2</sub> concentrations (Goffman et al., 2005). In green oilseeds, photosystems thus play a dual role, supplying NADPH and ATP for energetically expensive fatty acid syntheses and preventing hypoxia (Ruuska et al., 2004).

### Starch Transient Accumulation in Early Maturing Embryos

Transient starch deposition occurs in early maturing embryos of *A. thaliana* (Baud and Graham, 2006) and *B. napus* (da Silva et al., 1997). In embryos of *A. thaliana*, starch content peaks at 10 DAP and then drops regularly during late maturation, resulting in the almost complete disappearance of starch in mature dry seeds (Baud et al., 2002; Focks and Benning, 1998). The route of starch synthesis has been mostly studied in developing rapeseed embryos (Rawsthorne, 2002). The starch accumulated in developing embryos originates from carbon imported into the embryo (da Silva et al., 1997). Within the plastids, glucose-6-phosphate (Glc-6-P) is metabolised to glucose-1-phosphate (Glc-1-P) by phosphoglucomutase (EC 2.7.5.1; Caspar et al., 1985; Periappuram et al., 2000) followed by the conversion of Glc-1-P to adenosine diphosphoglucose (ADP-Glc) by ADP-Glc pyrophosphorylase (AGPase, EC 2.7.7.27). AGPase is regarded as the key regulatory element of the starch biosynthetic pathway in embryos of *B. napus* seeds (Vigeolas et al., 2004). The subsequent incorporation of the glucose moiety into the starch granule is catalysed by starch synthases (da Silva et al., 1997; Kang and Rawsthorne, 1994). Starch degradation may be specifically catalysed by plastidial isoforms of  $\alpha$ -(EC 3.2.1.1) and  $\beta$ -amylases (EC 3.2.1.2) and phosphorylases (EC 2.4.1.1; da Silva et al., 1997). Interestingly, the ESTs of starch metabolism in developing seeds of *A. thaliana* represent an example of the apparent coordinate expression of genes encoding enzymes of the same metabolic pathway (White et al., 2000). Together with enzymatic activities associated with starch metabo-

lism, these expression data demonstrate that the changes in starch content throughout embryo development reflect the net balance between synthetic and degradative capacity rather than a synthetic phase followed by a degradative phase (da Silva et al., 1997). The role of this transient accumulation of starch in oilseeds is still a matter of debate. It has been proposed that starch constitutes an important carbon source required to sustain lipid synthesis during the phase of rapid oil deposition (Norton and Harris, 1975). Starch degradation may also provide precursors for the synthesis of sucrose and oligosaccharide (raffinose, stachyose) accumulated in seeds during late maturation to achieve desiccation tolerance (Leprince et al., 1990). Alternatively, the development of an early capacity for starch synthesis has been proposed to contribute to the establishment of the embryo as a sink organ prior to the onset of oil deposition (da Silva et al., 1997). This last hypothesis has been corroborated by the characterisation of transgenic *B. napus* lines exhibiting an embryo-specific reduction in AGPase activity (Vigeolas et al., 2004). Starch synthesis was inhibited in the developing embryos of these plants. This phenotype was accompanied both by a decrease in the rate of sucrose degradation and an inhibition of glycolysis and storage lipid synthesis in early- but not in late-maturing seeds. These results demonstrate that starch synthesis is required to establish the growing embryo as a sink during early-maturation. However, the final size, weight, and lipid content of these transgenic seeds were unmodified, indicating that seed filling is largely compensated for during mid- and late-maturation and making it unlikely that starch serves as an important carbon source for lipid or sucrose synthesis during the maturation process, at least under optimal growth conditions (Vigeolas et al., 2004).

## SYNTHESIS OF TRIACYLGLYCEROLS

### Production of Glycerol Backbones

Glycerol-3-phosphate (Gly-3-P) species constitute the backbones of TAG molecules. Measurements of Gly-3-P levels in developing *A. thaliana* (Gibon et al., 2002) or *B. napus* (Vigeolas and Geigenberger, 2004) seeds indicate that the rate of Gly-3-P provision is limiting during the rapid TAG accumulation phase. Together with the reported K<sub>m</sub> of the first enzyme catalysing the acylation of Gly-3-P in rapeseed, these measurements suggest that the availability of this substrate could restrict the overall rate of TAG accumulation (Perry et al., 1999). This hypothesis has been further demonstrated in *B. napus* by injecting various concentrations of glycerol in maturing seeds. These injections have led to an increase in Gly-3-P within 28 h and have specifically stimulated the sucrose flux into the TAG biosynthetic pathway (Vigeolas and Geigenberger, 2004). In plants, two enzymes can synthesise Gly-3-P. Glycerol kinase (GlyK; E.C. 2.7.1.30) is a cytosolic enzyme that converts glycerol into Gly-3-P (Huang, 1975; Sadava and Moore, 1987). Ubiquitously expressed in plant tissues, this enzyme is thought to be involved in the assimilation of glycerol (Eastmond, 2004) rather than in the supply of the Gly-3-P backbones used for TAG biosynthesis. The second route leading to Gly-3-P synthesis consists in the conversion of dihydroxyacetone phosphate (DHAP) and NADH to Gly-3-P and NAD<sup>+</sup>. This reaction is catalysed by Gly-3-P dehydrogenase (Gly3PDH; E.C. 1.2.1.12). In



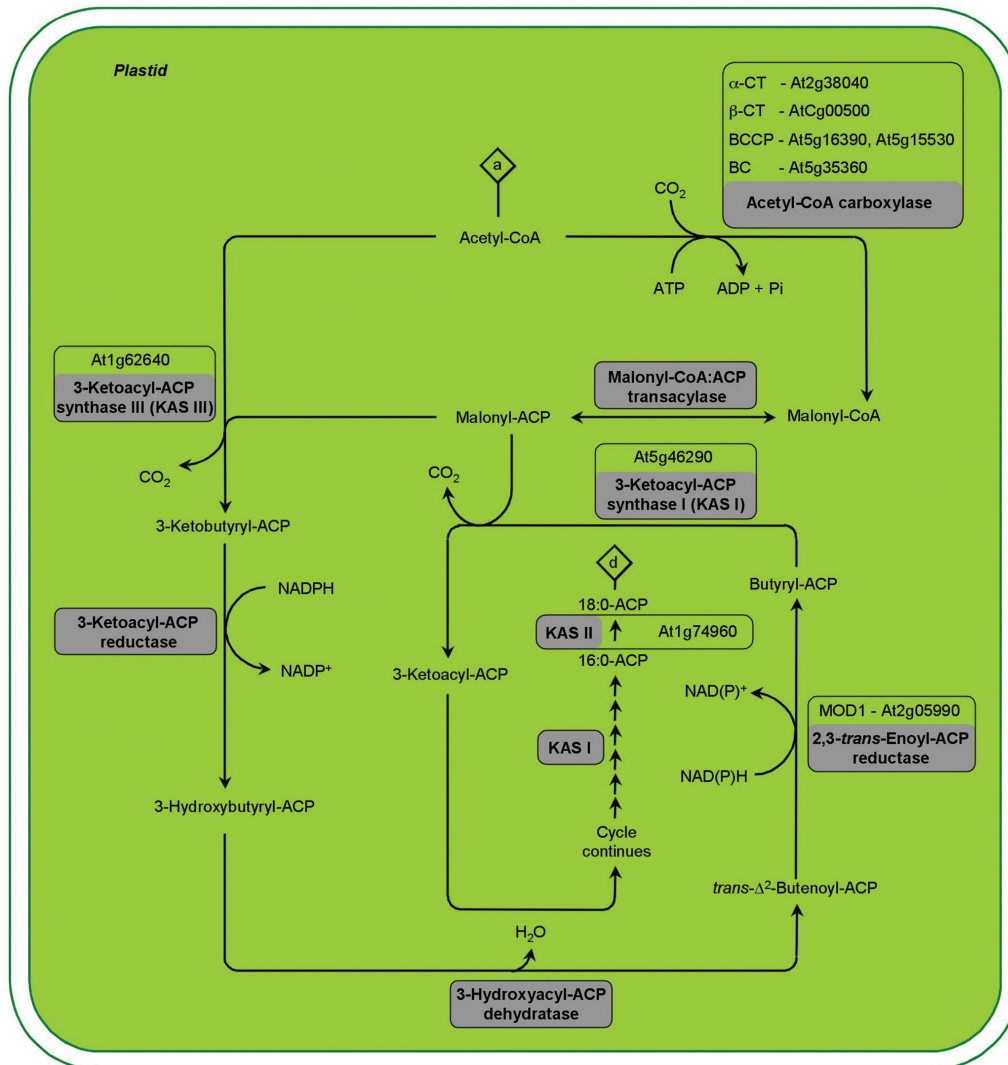

**Figure 3.** Fatty acid synthesis in the plastids of maturing embryos of *Arabidopsis thaliana*.

This scheme is adapted from Miquel and Browse (1995) and Somerville et al. (2000). Fatty acids are grown by sequential acylation of two-carbon units. The first condensation reaction is catalysed by ketoacyl-ACP synthase III (KASIII). During the following cycles, the condensation reaction is catalysed by KASI. Finally, the conversion of 16:0 to 18:0 is catalysed by KASII. ACP, acyl-carrier protein; CoA, coenzyme A. Letters in a diamond indicate metabolic links with pathways presented on figures 2 and 4

seeds like in leaves, both cytosolic and plastidial Gly3PDH isoforms have been identified (Kirsch et al., 1992; Sharma et al., 2001). The analyses of *A. thaliana* knock out mutants defective in the plastidic isoform of Gly3PDH encoded by gene At2g40690 (*SFD1/GLY1*) have ruled out the hypothesis of a significant involvement of this isoform in TAG biosynthesis (Miquel et al., 1998; Nandi et al., 2004). The lack of phenotype of *sfd1/gly1* seeds may be explained by the presence of a redundant isoform of Gly3PDH (At5g40610) in the plastids (Wei et al., 2001). Alternatively, the supply of Gly-3-P for oil synthesis may be carried out by cytosolic isoforms of Gly3PDH. A transgenic approach recently carried out in *B. napus* has strengthened this last hypothesis. The expression of a yeast gene coding for

cytosolic Gly3PDH (*gpd1*) in transgenic oilseed rape using the seed-specific napin promoter has led to a three- to fourfold increase in the level of Gly-3-P in developing seeds, resulting in a 40% increase in the final seed oil content (Vigeolas et al., 2007).

### Synthesis of Fatty Acids

Fatty acids are produced in the plastids from acetyl-CoA and malonyl-CoA (Figure 3). A multisubunit heteromeric acetyl-CoA carboxylase (ACCase; EC 6.4.1.2) catalyses the ATP-dependent formation of malonyl-CoA from acetyl-CoA and bicarbonate (Kon-

ishi et al., 1996). This reaction is the first committed step of *de novo* fatty acid biosynthesis and is regarded as a major control point of the pathway (Thelen and Ohlrogge, 2002a). ACCase contains three functional domains and catalyses a two step-reaction. Carboxylation of a biotin cofactor covalently bound to the central-carboxyl carrier domain (BCCP) is catalysed by the biotin carboxylase domain (BC). Transfer of the carboxyl group from carboxy-biotin to acetyl-CoA occurs at the carboxyltransferase domain (CT). The BC subunit is encoded by gene At5g35360 (*CAC2*, Sun et al., 1997). The CT domain is composed of associated non-identical CT $\alpha$  and CT $\beta$  subunits encoded by At2g38040 and AtCg00500, respectively. Two isoforms of the BCCP protein are encoded by genes At5g15530 (*BCCP2*) and At5g16390 (*BCCP1*). The malonyl-CoA produced by plastidial ACCase constitutes the carbon donor for each cycle of the fatty acid biosynthetic process. However, the malonyl group has to be transferred from CoA to a protein cofactor, or acyl carrier protein (ACP) before entering the fatty acid synthesis pathway. This transfer is catalysed by a malonyl-CoA: acyl carrier protein malonyltransferase (EC 2.3.1.39).

The *de novo* biosynthesis of fatty acids is performed by fatty acid synthase (FAS), an easily dissociable multisubunit complex consisting of monofunctional enzymes (Brown et al., 2006), including 3-ketoacyl-ACP synthase (EC 2.3.1.41; KAS), 3-ketoacyl-ACP reductase (EC 1.1.1.100), 3-hydroxyacyl-ACP dehydratase (EC 4.2.1.\*), and enoyl-ACP reductase (EC 1.3.1.9; MOD1, At2g05990) (Mou et al., 2000). Acetyl-CoA is used as the starting unit and malonyl-ACP as the elongator. The malonyl-thioester enters into a series of condensation reactions with acetyl-CoA, then acyl-ACP acceptors. The initial condensation reaction is catalysed by KAS III (2:0 to 4:0-ACP; At1g62640), the subsequent condensations by KAS isoforms I (4:0-ACP to 16:0-ACP; At5g46290) and II (16:0-ACP to 18:0-ACP; FAB1, At1g74960, Pidkowich et al., 2007). Each condensation step is followed by a reduction of the carbonyl group, a dehydration step, and a reduction of the *trans*-2 double bond to obtain a saturated acyl chain that is two carbons longer than at the start of the cycle. Some 16:0-ACP is released from the FAS machinery, whereas molecules that are elongated to 18:0-ACP are efficiently desaturated by a stromal stearyl-ACP desaturase (EC 1.14.19.2) (Browse and Somerville, 1991). Thus, 16:0-ACP and 18:1-ACP constitute the main products of plastidial fatty acid synthesis (Miquel and Browse, 1995). Following their synthesis, these long-chain acyl groups are hydrolysed by an acyl-ACP thioesterase (FAT) that releases free fatty acids. The FATA class (EC 3.1.2.14) has highest *in vitro* activity for 18:1-ACP whereas FATB (EC 3.1.2.\*; At1g08510; Bonaventure et al., 2003) prefer saturated acyl groups but also have activity for unsaturated acyl-ACPs (Salas and Ohlrogge, 2002). On the outer membrane of the chloroplast envelope, these free fatty acids are finally activated to coenzyme A (CoA) esters by an acyl-CoA synthetase and exported to the endoplasmic reticulum (ER).

## Fatty Acid Modifications

**Synthesis of very long chain fatty acids.** The seeds of *A. thaliana* contain approximately 30% of very long chain fatty acids (VLCFAs; 20-24 carbons), eicosenoic acid (C20:1) being the predominant VLCFA species (23 mol%). VLCFA are released in the ER as CoAs after sequential addition of two-carbon moieties from

malonyl-CoA at the carboxyl end of pre-existing 18-carbon fatty acids (Figure 4). Fatty acid elongase, which catalyses VLCFA biosynthesis, is a membrane-bound multienzyme complex. Analogous to *de novo* fatty acid synthesis, each cycle of fatty acid elongation involves four enzymatic reactions: (i) condensation of malonyl-CoA with a long chain acyl-CoA is catalysed by a 3-ketoacyl-CoA synthase (KCS, condensing enzyme); (ii) reduction to  $\beta$ -hydroxyacyl-CoA is made by a 3-ketoacyl-CoA reductase; (iii) dehydration to an enoyl-CoA is catalysed by a 3-hydroxyacyl-CoA dehydratase; (iv) and an enoyl-CoA reductase catalyses the reduction of the enoyl-CoA, resulting in an elongated acyl-CoA (von Wettstein-Knowles, 1982). The initial step in fatty acid elongation, the iterative condensation of acyl-CoA units with malonyl-CoA by KCS, is rate limiting. The KCS also plays a key role in determining the chain length of fatty acids found in seed oils (Blacklock and Jaworski, 2006; Katavic et al., 2001; Millar and Kunst, 1997). Among the large family of condensing enzymes found in the genome of *A. thaliana*, a seed-specific KCS (*FAE1*, At4g34520) has been identified (James et al., 1995; Roscoe et al., 2001; Rossak et al., 2001; Wu et al., 2007) that is responsible for the biosynthesis of C20 and C22 fatty acids for seed storage lipids. Several studies of the structure/function basis of KCS catalysis and substrate specificity have been reported. Site-directed mutagenesis experiments have enlightened the importance of Cys-223 and four His residues for the enzyme activity (Ghanavati and Jaworski, 2001), while domains found in the amino terminal one-third of the protein excluding the transmembrane domain have been shown to impart chain-length substrate specificity (Blacklock and Jaworski, 2002). In contrast with the KCS enzymes, it has been proposed that the other three enzyme activities of the elongase complex exhibit broad substrate specificities and are shared by all the plant VLCFA biosynthetic pathways (Millar and Kunst, 1997). This hypothesis has been partially confirmed by the recent isolation of an *A. thaliana* gene encoding an enoyl-CoA reductase (*ECR*; At3g55360) based on its similarity to the yeast *TSC13* gene (Kohlwein et al., 2001). The *ECR* gene is ubiquitously expressed and the corresponding mutants exhibit pleiotropic phenotypes including a significant reduction in VLCFA content of seed TAGs (Zheng et al., 2005). However, considering the amount of VLCFAs still accumulated in these mutant lines, it is very likely that other *ECR* participate in VLCFA elongation in *A. thaliana*. So far, they have not been identified. Likewise, the genes encoding the other reductase and the dehydratase of the elongase complex remain to be isolated.

Because cellular membranes are impermeable to acetyl-CoA and malonyl-CoA, the synthesis of these compounds is thought to occur in each cellular compartment where they are required (Liedvogel, 1986). The malonyl-CoA species used for VLCFA biosynthesis are consequently produced in the cytosolic compartment, where they are derived from citrate through the sequential action of ATP-citrate lyase (ACL; EC 4.1.3.8) and acetyl-CoA carboxylase (ACCase; EC 6.4.1.2). ACL catalyses the ATP-dependent reaction of citrate and coenzyme A to form acetyl-CoA and oxaloacetic acid (Fatland et al., 2002). The enzyme is a heterooctamer consisting of ACLA and ACLB subunits, each subunit being encoded by a small gene family (Fatland et al., 2005). ACCase then catalyses the ATP-dependent formation of malonyl-CoA from acetyl-CoA and bicarbonate (Konishi and Sasaki, 1994). Like the plastidial ACCase involved in the *de novo* fatty

acid synthesis, the cytosolic ACCase contains three catalytic domains necessary to catalyse the two-step carboxylation of acetyl-CoA (Ke et al., 2000). However, the cytosolic isoform is a multifunctional homodimeric form composed of subunits >200 kDa (Alban et al., 2000) encoded by the *ACC1* gene (At1g36160; Baud et al., 2003; Yanai et al., 1995). This gene is ubiquitously expressed, corresponding *acc1* mutant embryos are totally deprived of VLCFAs and the mutation is embryo lethal (Baud et al., 2003; Baud et al., 2004).

**Fatty acid desaturation.** In *A. thaliana*, desaturated fatty acid species like linoleic (18:2 $\Delta^{9cis, 12cis}$ ) and linolenic acids (18:3 $\Delta^{9cis, 12cis, 15cis}$ ) account for 45-50% of the seed fatty acid content. The synthesis of these two fatty acids proceeds by sequential desaturation of oleic acid (18:1 $\Delta^{9cis}$ ) to linoleic by  $\Delta^{12}$  oleate desaturase (FAD2), and then linoleic acid to linolenic acid by  $\omega$ -3-fatty acid desaturase (FAD3) (Figure 4). The cloning of *FAD2* (At3g12120) was allowed by a T-DNA tagging method (Okuley et al., 1994). *FAD3* (At2g29980) was isolated both by map-based chromosome walking (Arondel et al., 1992) and T-DNA tagging (Yadav et al., 1993). Both genes are significantly up-regulated in maturing seeds. The corresponding desaturases are inserted co-translationally into the ER (MacCartney et al., 2004), where they act on fatty acids esterified to phosphatidylcholine (PC), and utilise cytochrome *b5* as an intermediate electron donor. Considering that cytochrome *b5* is reduced in turn by cytochrome *b5* reductase, three proteins are required for the overall desaturation reaction (Somerville et al., 2000).

### Triacylglycerol Assembly

TAG assembly takes place within the ER, with Gly-3-P and acyl-CoAs as the primary substrates (Stymne and Stobart, 1987). Several pathways leading to TAG biosynthesis have been described to date (Figure 4). One known as the Kennedy pathway is relatively straightforward (Kennedy, 1961). Fatty acids are sequentially transferred from CoA to positions *sn*-1 and *sn*-2 of Gly-3-P. Gly-3-P is first acylated by a glycerol-3-phosphate acyltransferase (G3PAT; EC 2.3.1.15) to form lysophosphatidic acid (LPA), which in turn is acylated by lysophosphatidic acid acyltransferases (LPAAT; EC 2.3.1.51) to produce the central metabolite phosphatidic acid (PA). Dephosphorylation of PA by phosphatidic acid phosphohydrolase (PAP; EC 3.1.3.4) releases diacylglycerol (DAG). In the final step of TAG assembly, a third fatty acid is transferred to the vacant position *sn*-3 of DAG by diacylglycerol acyltransferases (DAGAT; EC 2.3.1.20; Cao et al., 1986; Cao et al., 1987). Two ER-localised and structurally unrelated enzymes exhibiting DAGAT activity have been described in *A. thaliana* that are encoded by genes At2g19450 (*TAG1*) and At3g51520, respectively (Hobbs et al., 1999; Routaboul et al., 1999; Zou et al., 1999). Fatty acids produced in the plastid are not always immediately available for TAG biosynthesis, however. Instead, the acyl chains can enter into phosphatidylcholine (PC) (and into phosphatidyl ethanolamine to a lesser extent), where they become desaturated or otherwise modified (Browse and Somerville, 1991). In this case, PC is synthesised from DAG by CDP-choline: diacylglycerol cholinephosphotransferase (CPT; EC 2.7.8.2) and acyl residues are then further desaturated by fatty acid desaturases (FAD). The CPT reaction being rapidly reversible (Vogel and

Browse, 1996), the DAG moiety of PC can be liberated by hydrolysis at any moment, thus becoming available for TAG final assembly by DAGAT (Stymne and Stobart, 1987). However, it is to be noted that fatty acids from PC may also become available for TAG synthesis by acyl exchange between a fatty acid attached to CoA (from the acyl-CoA pool) and a fatty acid on PC, this reversible reaction being catalysed by acyl CoA: lysophosphatidylcholine acyltransferase (LPCAT, EC 2.3.1.23). Recently, a second mechanism of TAG synthesis has been described. In this acyl-CoA independent pathway, a phospholipid such as PC or phosphatidyl ethanolamine can donate its *sn*-2 acyl group to DAG resulting in formation of TAG (Ståhl et al., 2004). This transacylase activity is catalysed by a phospholipid: diacylglycerol acyltransferase (PDAT; EC 2.3.1.158).

The TAG biosynthetic pathway has many reactions in common with the synthesis of membrane lipids, DAG being also a precursor for membrane PC. This observation raises the question of the enzymes involved in TAG biosynthesis in seeds. Special isoforms may be involved in this metabolic process. Alternatively, some housekeeping isoforms may be up-regulated (Beisson et al., 2003). Eight GPAT genes and five LPAAT genes have been found in the genome of *A. thaliana*. Most of the corresponding enzymes are probably targeted to the ER but to date, none of them has been shown to play a clear role in seed TAG biosynthesis (Beisson et al., 2007; Kim et al., 2005b). A detailed characterisation of these two gene families will be required to get further insights into the understanding of fatty acid fluxes into TAGs during seed maturation. Beyond the identification of the isoforms involved in TAG formation, the characterisation of their ER localisation will contribute to elucidate cellular aspects of storage oil formation. One of the long-standing questions in plant lipid metabolism has been whether there was a specific region of the ER specifically dedicated to TAG synthesis. Recent evidence suggests that this is likely to be the case (Shockey et al., 2006).

### Storage of TAGs in Oil Bodies

TAGs are accumulated in subcellular structures called oil bodies. Seed oil bodies are simple organelles comprising a matrix of TAGs surrounded by a phospholipid monolayer where the aliphatic chains are oriented to the TAG lumen and the phosphate groups toward the cytosol (Yatsu and Jacks, 1972). Oil bodies are derived from the ER and the exact mechanism of their biogenesis remains a matter of debate (Murphy and Vance, 1999; Robenek et al., 2004) (Figure 5). It has been proposed that TAGs accumulate within the lipid bilayer of the ER membrane from where they are budded of, enclosed by a protein-bearing phospholipids monolayer originating from the cytosolic leaflet of the ER membrane. Recent observations suggest an entirely different mechanism of lipid droplet biogenesis involving the elaboration of droplets within ER cups, rather than between the leaflets of the ER membrane, with adipophilin clusters in the cytoplasmic leaflet of the ER transferring lipids from the ER to the droplet surface (Robenek et al., 2006). A specific subset of proteins is embedded in the lipid monolayer surrounding oil bodies that represents 1-4% of the weight of seed oil bodies (Huang, 1992; Tauchi-Sato et al., 2002; Tzen and Huang, 1992). Recent proteomic efforts have provided a detailed characterisation of the

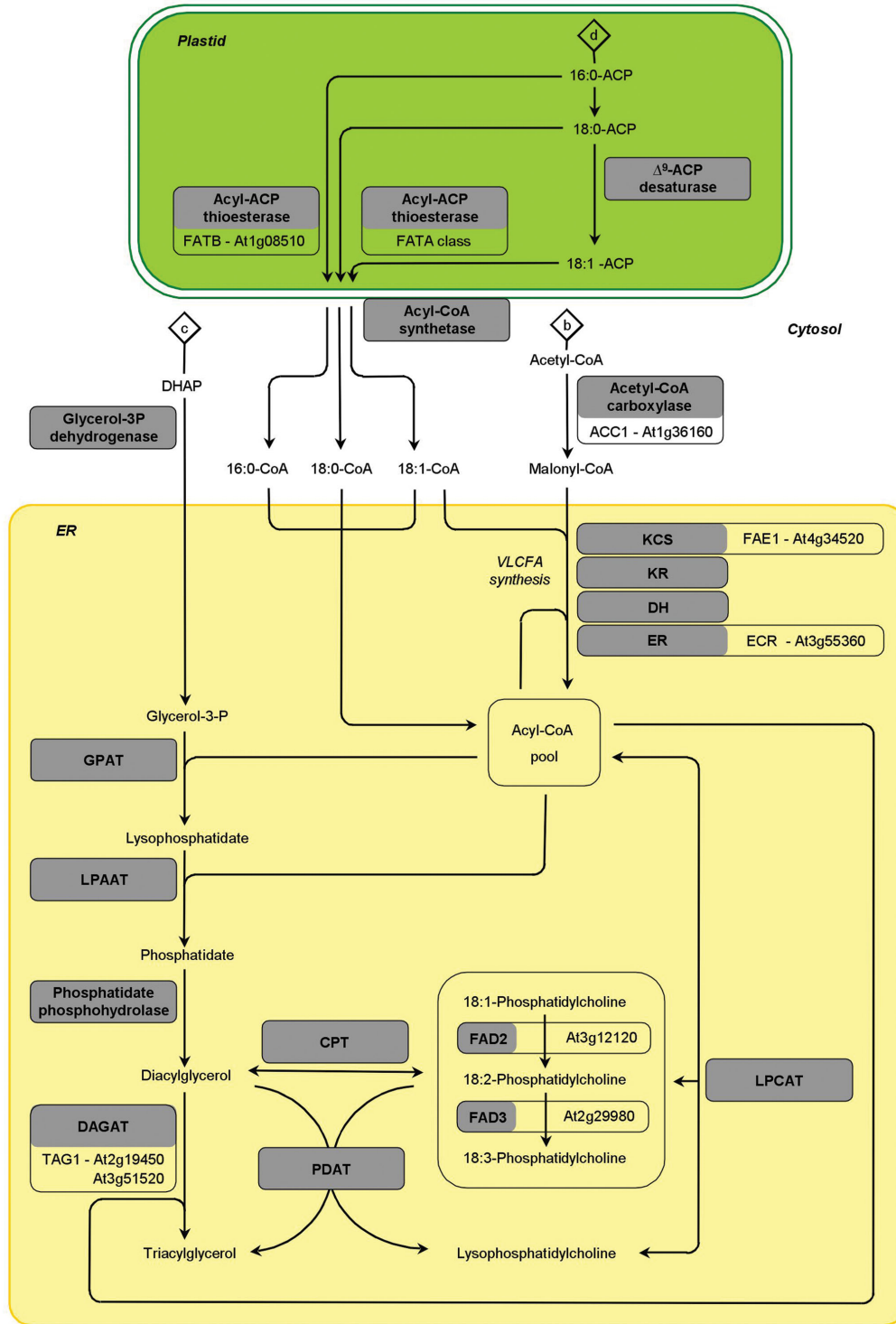

**Figure 4.** Simplified scheme of the reactions involved in triacylglycerol biosynthesis in seeds of *Arabidopsis thaliana*.

Fatty acids are synthesised in the plastids, and 16:0 and 18:1 are massively exported toward the cytosolic compartment as CoA esters. Glycerol backbones are derived from cytosolic dihydroxyacetone phosphate (DHAP) through the action of glycerol-3-phosphate dehydrogenase. The enzymes of the Kennedy pathway catalyse triacylglycerol assembly in the endoplasmic reticulum. The contribution of the acyl-CoA independent phospholipid:diacylglycerol acyl-transferase (PDAT) is presented. ER, endoplasmic reticulum; FAD2, oleoyl desaturase; FAD3, linoleoyl desaturase. Letters in a diamond indicate metabolic links with pathways presented on figures 2 and 3

set of proteins imbedded in the half membrane unit of *A. thaliana* oil bodies (Jolivet et al., 2004). The oil body proteome consists of five distinct oleosins (S1/OLEO5, At3g01570; S2/OLEO4, At3g27670; S3/OLEO1, At4g25140; S4/OLEO2, At5g40420; S5/OLEO3, At5g51210), one caleosin (CLO1, At4g26740; Poxleitner et al., 2006), one steroleosin (HSD1, At5g50600/At5g50700; d'Andréa et al., 2007; Li et al., 2007a), a putative aquaporin (TIP3.2, At1g17810), and a glycosylphosphatidylinositol (GPI)-anchored protein (At1g54860). The most abundant oil-body associated proteins are oleosins and much of the oil-body surface may be covered by these proteins (Tzen and Huang, 1992). These alkaline, amphipatic proteins contain three structural domains: an N-terminal amphipatic domain, a central hydrophobic domain, and a C-terminal amphipatic domain. The central domain is organised around a unique 12-amino acid motif called a proline knot and is inserted into the oil body TAG matrix (Abell et al., 1997). The N- and C-terminal domains are proposed to reside on the oil-body surface (Frandsen et al., 2001). The accumulation of oleosins during maturation determines the size of oil bodies (Siloto et al., 2006). During late maturation, when the seed water content sharply decreases, oil bodies experience cytoplasmic compression. They are forced into contact with each other in the periphery of embryonic cells. Yet they resist coalescence and remain as individual units. The oleosins embedded in the phospholipids monolayer form a steric barrier and maintain oil bodies as small individual units by means of steric hindrance and electronegative repulsion (Leprince et al., 1998; Murphy and Vance, 1999). Oil bodies thus provide a high surface-to-volume ratio that optimises access by lipases during reserve mobilisation.

## SEED STORAGE PROTEINS

### Diversity of Seed Storage Proteins

Seeds of *A. thaliana* contain two predominant classes of SSPs named after those of *B. napus* (for a review, see Fujiwara et al., 2002). Legumin-type globulins are referred to as 12S globulin or cruciferin (Li et al., 2007b; Sjobahl et al., 1991), and napin-type albumins are referred to as 2S albumin or arabin (Krebbers et al., 1988; van der Klei et al., 1993). The 12S globulins accumulate as complexes consisting of six  $\alpha$  and six  $\beta$  subunits linked via disulfide bonds. The mature  $\alpha$  and  $\beta$  polypeptides are proteolytically processed from a single precursor. In the *A. thaliana* genome of Columbia ecotype, four genes encoding 12S precursors have been identified (Gruis et al., 2002; Gruis et al., 2004; Pang et al., 1988), including *CRA1* (At5g44120), *CRB* (At1g03880), *CRC* (At4g28520), and *CRU2* (At1g03890). The 2S albumins accumulate as heterodimers consisting of two subunits (also called large and small chains) generated by cleavage of a precursor and linked by disulfide bridges (Guerche et al., 1990; Krebbers et al., 1988). Five genes encoding 2S precursors have been reported, referred to as *At2S1* (At4g27140), *At2S2* (At4g27150), *At2S3* (At4g27160), *At2S4* (At4g27170), and *At2S5* (At5g54740). Additional minor SSPs encoded by a vicilin-like gene (At2g18540) and two globulin-like genes (At1g07750 and At4g36700) may be stored in the seeds of *A. thaliana* (Fujiwara et al., 2002). Other proteins such as late abundant em-

bryogenesis (LEAs) proteins may account for a limited amount of nitrogen stored in the seed (Fujiwara et al., 2002; Wise et al., 2004).

### Synthesis of Seed Storage Proteins

SSPs are actively synthesised on the rough ER as precursor forms and then are transported into PSVs by a vesicle-mediated pathway. Upon arrival at the PSV, the precursors are converted into their respective mature forms by limited proteolysis at specific sites. Prolegumin-type globulins are believed to be inserted cotranslationally into the ER lumen, where the formation of disulfide bonds and assembly into trimers occur (Muntz, 1998). After transport to PSVs, proteolytic processing at a conserved Asn-Gly peptide bond by an asparaginyl endopeptidase converts the pro-form into the disulfide-linked mature  $\alpha$  and  $\beta$  polypeptides. This cleavage is concomitant with a further assembly of the trimer protein complexes into hexamers that sediment as a 12S complex (Barton et al., 1982). The proteolytic processing of pronapin-type albumins appears to be more complex, requiring removal of three propeptide regions to generate the two disulfide-linked mature polypeptides (Krebbers et al., 1988). Several of the proteolytic steps also involve a conserved Asn residue (Krebbers et al., 1988). Yet, additional aspartic endopeptidases may be involved in the processing of the propeptides (D'Hondt et al., 1993). If the post-translational polypeptide cleavage events leading to the synthesis of mature SSPs are well described, the function of such a complex processing is less clear. The protein conformational changes thus triggered might enable dense packaging and long-term stable storage of reserves within PSV, a compartments that presumably contains proteolytic enzymes for the mobilisation of SSPs during germination (Gruis et al., 2004). Work to isolate the Asn-specific endopeptidases responsible for the proteolytic processing of prolegumin-type globulins and pronapin-type albumins has led to the identification of an Asn-specific subclass (C13; EC 3.4.22.34) of the Cys endopeptidase family, referred to as the vacuolar processing enzymes (VPEs) (Hara-Nishimura et al., 1991; Hara-Nishimura et al., 1995). In *A. thaliana*, the VPE gene family is composed of four genes (Gruis et al., 2002; Kinoshita et al., 1995a; Kinoshita et al., 1995b; Kinoshita et al., 1999), namely  $\alpha$ VPE (At2g25940),  $\beta$ VPE (At1g62710),  $\gamma$ VPE (At4g32940), and  $\delta$ VPE (At3g20210). These genes exhibit distinct but partially overlapping expression patterns, and at least three of these VPEs are involved in SSPs processing (Gruis et al., 2004). The degree of involvement of these three genes ( $\beta$ VPE >  $\gamma$ VPE >  $\alpha$ VPE) appears to be correlated with the abundance of their respective transcripts during seed maturation. Interestingly, the complete removal of VPE function in the  $\alpha$ vpe  $\beta$ vpe  $\gamma$ vpe  $\delta$ vpe quadruple mutant results in a total shift of SSPs accumulation from wild-type processed polypeptides to a finite number of alternatively processed forms cleaved at sites other than the conserved Asn residues targeted by VPEs. This demonstrates that VPE-mediated processing of SSPs is not compulsory for the successful depositions of these SSPs. The emergence of alternatively processed peptides then reveals Asn-independent proteolytic activities (e.g. aspartic protease; Hirawai et al., 1997) probably less active than VPE activities in maturing seeds of the wild type (Gruis et al., 2004).

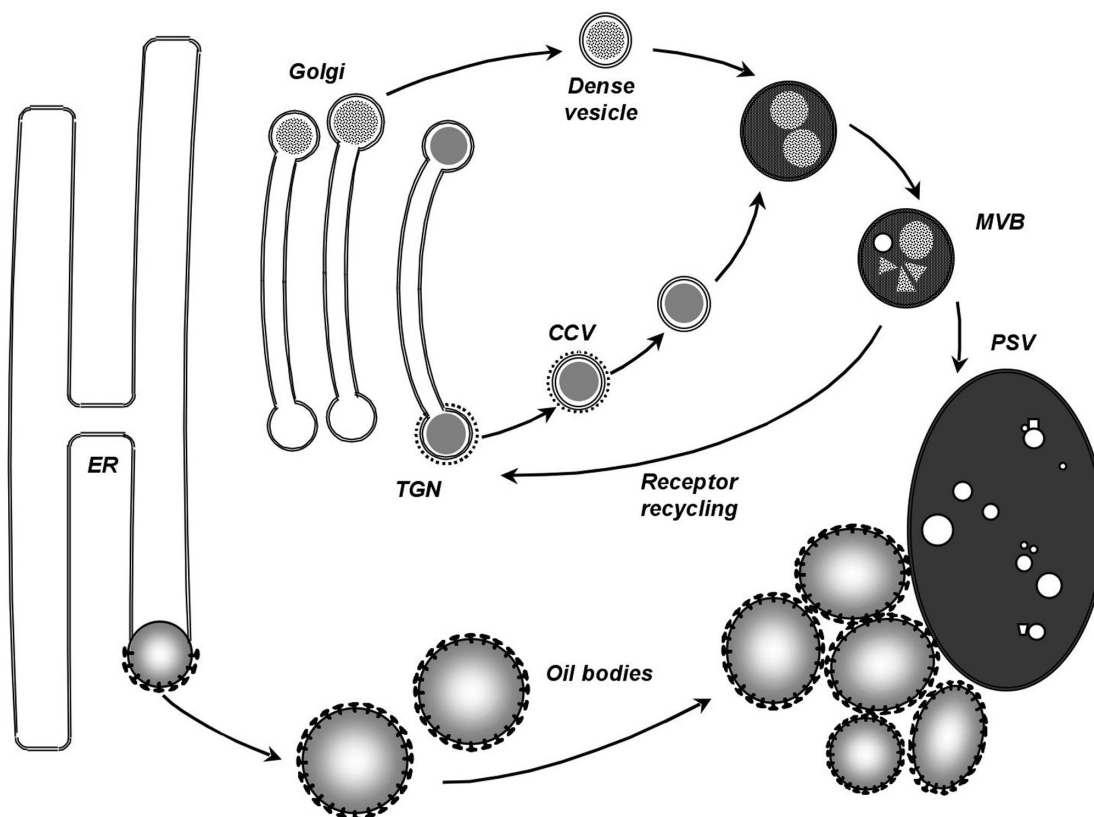

**Figure 5.** Sorting and trafficking of reserve compounds in maturing seeds of *Arabidopsis thaliana*.

This scheme is adapted from Otegui et al. (2006). CCV, clathrin coated vesicles; ER, endoplasmic reticulum; MVB, multivesicular bodies; TGN, *trans* Golgi network; PSV, protein storage vacuole.

### Protein Storage Vacuoles

Most SSPs are synthesised in the ER as precursors that are transported into PSVs, where they are converted into mature forms (Figure 5). PSVs are electron dense vacuolar compartments delimited by a lipid bilayer, the tonoplast. The internal environment of PSVs, the matrix, contains not only soluble storage proteins, but also intra-organellar inclusions called globoids, that correspond to spherical inclusions of phytate (Gillespie et al., 2005). In *A. thaliana*, a Golgi-dependent pathway is responsible for the transport of the soluble SSPs and their processing enzymes to the PSVs (Otegui et al., 2006). Yet, storage proteins and processing enzymes are segregated into different cisternal domains during Golgi trafficking. SSPs become sequestered into dense aggregates formed in the specialised marginal buds of the *cis*-Golgi cisternae that progress through the stack as the cisternae mature (Hillmer et al., 2001). Upon reaching the *trans*-Golgi network, the buds containing protein aggregates give rise to electron-dense vesicles (DVs). Processing enzymes ( $\beta$ -VPE, aspartic protease) may be packaged in clathrin-coated vesicles that ultimately fuse to the DVs to produce multivesicular bodies (MVBs), which act as prevacuolar compartments. The proteolytic pro-

cessing of 2S albumins begins in the MVBs, leading to conformational changes that decrease their solubility and make them more resistant to further proteolysis inside the PSVs (Gruis et al., 2004). If SSP aggregation plays a key role in protein sorting, vacuolar sorting receptors are also required for selective recognition and sorting of these proteins (Hinz et al., 2007). Two different types of receptors are currently in discussion in the plant literature. RMR1 (for receptor homology region transmembrane domain ring H2 motif protein; At5g66160) may function as the main receptor for PSV-destinated storage proteins (Park et al., 2005). The interaction between RMR1 and 2S albumin- and/or 12S globulin-type SSPs remains to be demonstrated. RMR proteins are not recycled from the MVBs and must accompany their attached cargo to the PSVs (Hinz et al., 2007). Some storage proteins are thought to escape this sorting machinery and to reach the *trans* Golgi, where a second type of receptor called VSR-1/A TELP1 (At3g52850) might catch them. The VSR-1/A TELP1 protein may thus be required for a complete and efficient targeting of SSPs (Shimada et al., 2003). Unlike RMR1, the VSR-1 receptor, which binds SSPs in a  $\text{Ca}^{2+}$ -dependent manner, has been postulated to be recycled back from MVBs to the *trans*-Golgi network by a retromer-mediated mechanism (Oliviusson et al., 2006; Fuji et al.,

2007) that could involve the MAIGO1 (MAG1/VPS29, At3g47810) protein (Shimada et al., 2006).

## DEVELOPMENTAL CONTROL OF SEED FILLING

### Hormones and Sugars

ABA immunomodulation in transgenic tobacco seeds has clearly established the key role played by this hormone in triggering the maturation process (Phillips et al., 1997). Since then, it has been shown that the ABA-to-GA ratio regulates seed maturation (Finkelstein et al., 2002). At the beginning of the maturation phase, the seed ABA content steadily increases, and the resulting elevated ABA-to-GA ratio inhibits embryo growth and germination, induces seed dormancy, and promotes maturation (Nambara and Marion-Poll, 2005). If early maturing embryos are removed from the seed, thus alleviating the ABA effect, they can proceed through the germination phase and develop into seedlings (Vicente-Carbajosa and Carbonero, 2005). The regulatory mechanisms involving ABA and GA during seed development and maturation yet remain to be fully elucidated (Finkelstein et al., 2002).

The carbohydrate status has been proposed as a control element of seed development in legume seeds: a high glucose-to-sucrose ratio is correlated with cell divisions (embryo morphogenesis) whereas a high sucrose-to-glucose ratio triggers storage product synthesis (maturation) (Weber et al., 1997). Similar variations of the carbohydrate status have been measured on whole seeds at the onset of the maturation phase in *A. thaliana* (Baud et al., 2002; Ohto et al., 2005). However, the role of the hexose-to-sucrose ratio in the control of the switch to storage product accumulation in oilseeds remains highly controversial (Tomlinson et al., 2004). The elucidation of the putative regulatory role of sucrose and hexoses in the developing *A. thaliana* seed will require a fine characterisation of the biochemistry and enzymology of sugar metabolism linked to a better understanding of the ultrastructure of the seed (Hill et al., 2003). Trehalose-6-phosphate (T6P) is also thought to play a role of the utmost importance in developing *A. thaliana* embryos. Mutants disrupted in the *TREHALOSE-6-PHOSPHATE SYNTHASE1* (*TPS1*) gene (At1g78580) do not develop past late torpedo or early cotyledon stage, accumulate limited quantities of storage compounds and consequently produce wrinkled seeds (Eastmond et al., 2002; Gomez et al., 2005; Gomez et al., 2006). To date, the molecular mechanism involved in this regulatory process remains to be elucidated. If the role of sugar metabolism in the regulation of storage function is not understood, it is clear that sugar-sensing pathways interact with hormonal signalling (Avonce et al., 2004; Leon and Sheen, 2003).

### Master Regulators

The isolation and characterisation of mutants skipping the maturation phase and displaying a viviparous behaviour has enabled the identification of master genes that determine a state of competence under which maturation gene expression programmes occur (Vicente-Carbajosa and Carbonero, 2005; Wobus and Weber, 1999). In *A. thaliana*, four loci have been identified, namely *FUSCA3* (*FUS3*, At3g26790), *ABSCISIC ACID INSENSITIVE3*

(*ABI3*, At3g24650) and *LEAFY COTYLEDON1* (*LEC1*, At1g21970) and 2 (*LEC2*, At1g28300), that control a wide range of seed-specific characters and play a role of the utmost importance in seed maturation. *FUS3*, *ABI3* and *LEC2* encode related transcription factors of the B3-domain family (Giraudat et al., 1992; Gazzarrini et al., 2004; Luerssen et al., 1998; Meinke et al., 1994; Stone et al., 2001), whereas *LEC1* encodes a protein homologous to the HAP3 subunit of the CAAT box-binding protein (Lee et al., 2003; Lotan et al., 1998). The *fus3*, *abi3*, *lec1* and *lec2* mutants share common phenotypes such as reduced accumulation of storage compounds, and exhibit specific phenotypes such as the lack of chlorophyll degradation, anthocyanin accumulation, intolerance to desiccation, or defects in cotyledon identity (see Table 1 in To et al., 2006). These master regulators exhibit partially overlapping expression patterns that include crosstalk and complex feedback regulations (Gutierrez et al., 2007; Santos Mendoza et al., 2005; To et al., 2006). The four regulators act in concert with hormone signalling (auxin, ABA, GA), epigenetic mechanisms involving the chromatin-remodelling factor (CHD3) PICKLE (PKL, At2g25170), and possibly other regulators like LEC1-Like (At5g47670) and TAN (At4g29860) (Santos Mendoza et al., 2008, and references therein).

These B3-type transcription factors appear to be involved in a local, intricate, and highly redundant gene regulation network governing most seed maturation aspects, including storage compound synthesis. Due to partial functional redundancy, genetic analyses have failed to determine the specific function of each regulator *in planta*. More recently, the use of inducible systems, coupled to quantitative RT-PCR experiments and/or transcriptomic analyses have finally unravelled some of the target genes of these master regulators (Kagaya et al., 2005) (Figure 6). *LEC2* exerts a direct control over *At2S1*, *At2S2*, *At2S3*, *At2S4*, *CRA1* and *2S-like* (At5g54740) gene expression (Braybrook et al., 2006; Kroj et al., 2003). Likewise, *FUS3* and *ABI3* contribute directly to the induction of storage protein gene expression (Ezcurra et al., 1999; Reidt et al., 2000). *LEC2* has then been shown to trigger the expression of genes encoding oleosins like *S3/OLEO1* and *HSD1* (Braybrook et al., 2006; Santos Mendoza et al., 2005). Using *in vitro* approaches (with *FUS3*, *LEC2* and *ABI3*) and yeast one-hybrid assays (with *LEC2* and *FUS3*), it was established that these B3-type regulatory proteins can recognise and bind RY motifs (CATGCA) present in the promoters of their target genes (Braybrook et al., 2006; Kroj et al., 2003; Monke et al., 2004; Reidt et al., 2000). However, RY elements alone are not always sufficient to confer the proper expression pattern of target genes during the maturation phase, and additional regulatory *cis*-acting elements like G boxes (CACGTG) may be required (Ezcurra et al., 1999; Kurup et al., 2000; Nakashima et al., 2006; Vicente-Carbajosa and Carbonero, 2005). These G-box elements may be bound by bZIP transcription factors like AtbZIP10 (At4g02640) or AtbZIP25 (At3g54620) that participate into the synergistic activation of target gene expression (Lara et al., 2003).

### Transcriptional Regulation of the Metabolic Network

Recent studies have clearly established that master regulators like *LEC2* or *FUS3* can trigger directly the transcription of SSP or oleosin genes. On the contrary, there were no clues to explain how

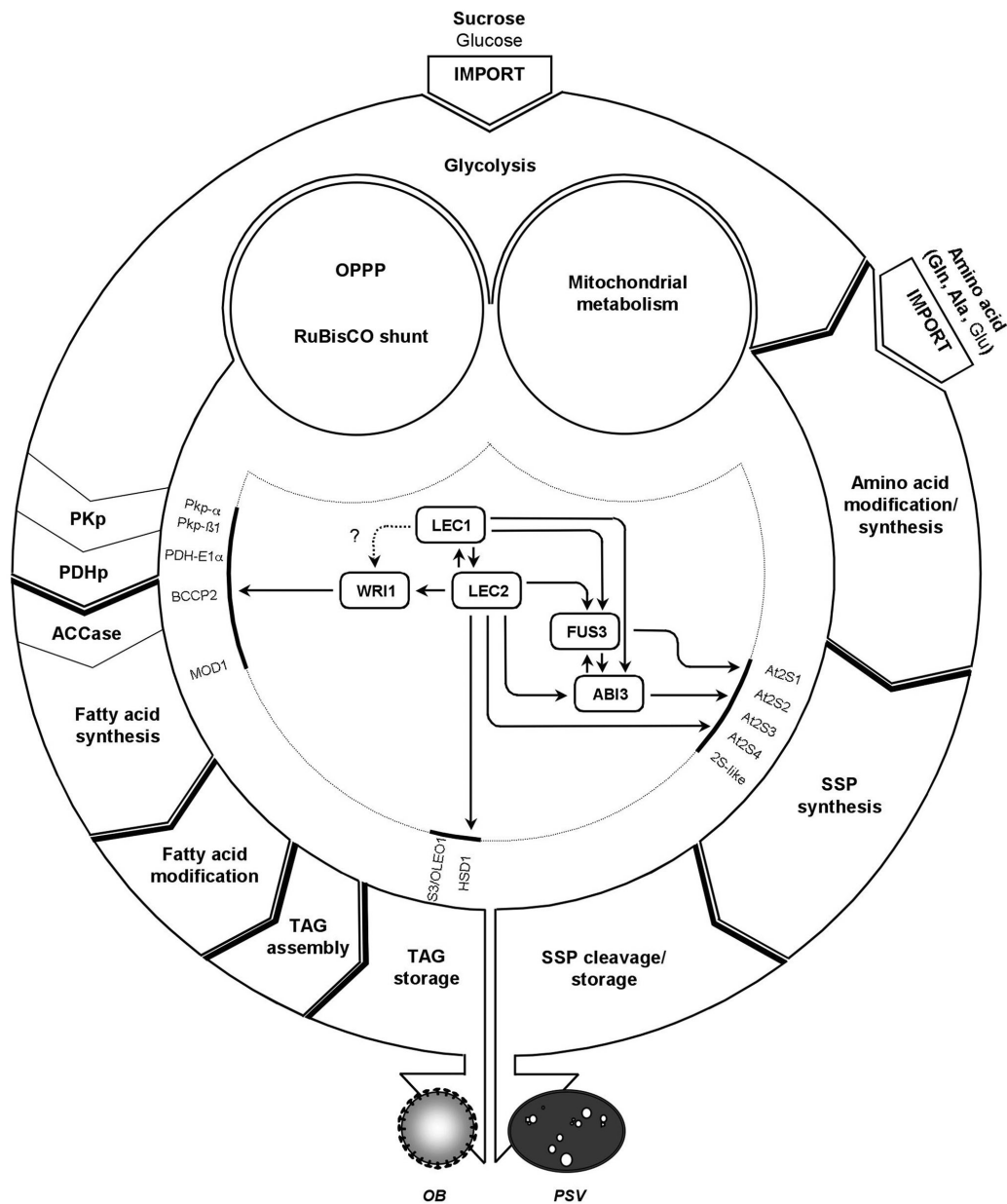

**Figure 6.** Model for the control of storage compound synthesis and accumulation in maturing seeds of *Arabidopsis thaliana*.

Precursors for fatty acid synthesis are derived from sucrose through the glycolysis, the OPPP and the RuBisCO shunt. Fatty acids synthesised in the plastids are then exported toward the cytosol in the form of acyl-CoAs, acylated on a glycerol backbone to form triacylglycerides, which are ultimately stored in oil bodies. Amino acids required for the synthesis of seed storage proteins are either directly imported from the maternal tissues or synthesised/modified in the embryo. Solid arrows represent positive transcriptional regulations. Target genes encoding actors of the metabolic network are placed in the inner ring of the scheme. ACCase, heteromeric acetyl-CoA carboxylase; FA, fatty acids; OPPP, oxidative pentose phosphate pathway; PDHp, plastidial pyruvate dehydrogenase complex; PKp, plastidial pyruvate kinase; SSP, seed storage proteins; TAG, triacylglycerides.

the master regulators could directly impact on primary metabolism and fatty acid biosynthesis. These observations have led to hypothesise that part of the seed maturation process is indirectly regulated via secondary transcription factors able to trigger their own transcription program (Gutierrez et al., 2007). *WRINKLED1* (*WRI1*; At3g54320) was thus shown to be a target of *LEC2* (Baud

et al., 2007a) that encodes a transcription factor of the APETALA2-ethylene responsive element-binding protein (AP2-EREBP) family (Cernac and Benning, 2004). In *wri1* maturing seeds, primary metabolism is compromised (Baud and Graham, 2006; Focks and Benning, 1998), rendering maturing embryos unable to efficiently convert sucrose into TAGs. Recent studies have led to the isolation



of putative targets of WRI1 (Baud et al., 2007a; Ruuska et al., 2002). These include several genes encoding enzymes of late glycolysis (*PKp- $\alpha$* , *PKp- $\beta$ 1*, *PDH-E1 $\alpha$* ) and the plastidial fatty acid biosynthetic machinery (*MOD1*). Taken together, these data illustrate how WRI1 specifies the regulatory action of a master regulator toward the metabolic network involved in the production of storage fatty acids (Figure 6). Interestingly, LEC1 may participate in the regulation of *WRI1* expression (Casson and Lindsey, 2006) and sucrose may play a role in triggering induction of *WRI1* (Masaki et al., 2005).

## METABOLIC ENGINEERING

Metabolic engineering can be defined as the redirection or modulation of flux through a metabolic pathway, resulting in an increase in the concentration of an existing compound or the accumulation of a novel product (Kinney, 2006). In *A. thaliana*, several attempts have led to successes in flux redirection, especially in the production of modified plant oils. Most of these attempts rely on the manipulation of lipid metabolism. To date, the protein-to-oil ratio and the factors controlling this ratio in oilseeds have been poorly investigated. Some modifications of this ratio have been reported as side effects of strategies specifically designed to enhance TAG production. The recent discovery that the over-expression, in *A. thaliana*, of two Dof-type transcription factor genes from soybean, *GmDof4* and *GmDof11*, induces the transcription of several genes of the fatty acid biosynthetic network whilst down-regulating *CRA1*, may pave the way for further investigations in this direction (Wang et al., 2007).

### Modification of Protein Content

The introduction of an “extra” member of the 2S albumin SSP family in transgenic *A. thaliana* has little or no effect on the expression of the genuine members of the family (Guerche et al., 1990). Data concerning the impact of this strategy on the overall amount of SSP stored are missing. An enhancement of the nitrogen status accompanied by an elevation of the seed protein content has been obtained in transgenic lines overexpressing constitutively *ASN1* (At3g47340), the major expressed gene for Asn synthase (EC 6.3.5.4) (Lam et al., 2003). This is at least partially due to an increased transport of Asn from source to sink via the phloem and illustrates how seed protein content depends on amino acid supply (Hernandez-Sebastia et al., 2005; Rolletschek et al., 2005).

The structural features of SSPs require a specific amino acid composition for each storage protein. To be efficiently incorporated into SSPs, the content in free amino acids in plant seeds should fit the amino acid composition of SSPs. This requirement may involve a supercomposite regulatory network of amino acid metabolism (Galili and Höfgen, 2002). Several attempts have concentrated on the manipulation of amino acid balance in seeds to increase the content of “essential” amino acids like lysine or methionine that contribute significantly to the nutritional quality of plant products. Efforts to improve lysine production in seeds have firstly utilised bacterial dihydrodipicolinate synthase (DHPS) enzymes that are much less sensitive to lysine feedback inhibition than their plant counterparts (Falco et al., 1995; Mazur et al.,

1999). Transgenic rapes over expressing DHPS have significantly elevated free lysine in mature seeds, but extreme free lysine overproduction cause problems of seed germination. Another approach to enhance the level of a given amino acid has consisted in transforming plants with genes encoding SSPs that are rich in the desired amino acid. If the expression of lysine-rich protein has been mostly performed in maize, several attempts have been made to accumulate methionine-rich 2S storage proteins like the Brazil nut 2S albumin in rapeseed (Altenbach et al., 1992; De Clercq et al., 1990). However, most of the genetic engineering strategies that have been recently developed to increase and/or modify the protein content of seeds have been conducted on legume (Rolletschek et al., 2005) and cereal species (Bhalla, 2006; Shewry, 2007).

### Modification of Oil Content

A first set of attempts has concentrated on the manipulation of total oil levels in seeds of *A. thaliana* and *B. napus*. Over-expression of individual genes involved in *de novo* fatty acid synthesis in the plastid has not allowed stimulating fatty acid production (Dehesh et al., 2001; Thelen and Ohlrogge, 2002b). The over-expression of the WRI1 transcription factor, regarded as central regulator of seed fatty acid synthesis, slightly increased the oil content of transgenic lines (Cernac and Benning, 2004). Whereas the manipulation of fatty acid synthesis seemed to have limited impact on the amount of oil stored, increased supply of glycerol backbones led to a significant improvement of the final seed oil content. The seed specific over-expression of a yeast gene coding for cytosolic Gly3PDH thus resulted in a 40% increase in oil content of transgenic rape seeds (Vigeolas et al., 2007). Likewise, studies investigating the over-expression of GPAT (Jain et al., 2000), LPAAT (Taylor et al., 2002; Zou et al., 1997) and DAGAT (Jako et al., 2001) demonstrated that the acylating steps of the Kennedy pathway exert significant control over the amount of oil stored in seeds.

A second set of attempts has focused on modifying the balance of fatty acids naturally occurring in seeds of *A. thaliana* or *B. napus*. Vegetable oils derived from the seeds of crop plants serve as easily extracted resource for both food and a variety of industrial applications. For many food applications, vegetable oils are made semisolid by hydrogenation. Unfortunately, this process increases saturated fatty acid content and also results in the production of *trans*-unsaturated fatty acids that have been associated with coronary heart disease (Broun et al., 1999). Vegetable oils with a reduced amount of *trans*-unsaturated fatty acids are consequently desirable to improve human health (Thelen and Ohlrogge, 2002). This can be achieved by down regulating endogenous stearoyl-ACP desaturase gene in *B. Napus* (Knutzon et al., 1992). For plant oils to be economically viable for the manufacture of specialty chemicals, these oils need to be highly enriched in fatty acid of interest (for a review, see Jaworski and Cahoon, 2003). When fatty acids of interest are naturally found at low levels in crop species, strategies can be developed to enhance their relative proportion by modulating the expression of appropriate endogenous genes (Dörmann et al., 2000) or by over-expressing related genes originating from other plant species (Dehesh et al., 1996; Hawkins and Kridl, 1998; Jones et al., 1995). Attempts have also been made to store intermediate species of

the fatty acid biosynthetic pathway that are not accumulated in wild-type seeds. The expression of a California bay thioesterase in the seeds of *A. thaliana* or *B. napus* thus results in the accumulation of laurate (12:0) up to 24 and 58% of total fatty acids, respectively, by short-circuiting the acyl chain elongation process (Voelker et al., 1992; Voelker et al., 1996). The additional introduction of a laurate-specific coconut LPAAT in transgenic *B. napus* lines further increases laurate accumulation, up to 67% (Knutzon et al., 1999).

Finally, many unusual fatty acids found in non-agronomic species exhibit properties that are suitable for industrial applications, including appropriate chain length, appropriate positioning and configuration of double bonds, presence of hydroxyl or epoxy groups. Biotechnological efforts have therefore focused on isolating genes that encode the enzymes required for the synthesis of these unusual fatty acids for transfer to *A. thaliana* and then/or to crop species like rape (Voelker and Kinney, 2001). In addition to the search for naturally occurring enzymes, there is potential for the rational design of enzymes to produce novel fatty acids with desired functionalities (Jaworski and Cahoon, 2003). The introduction, in *A. thaliana*, of acyl-ACP desaturases like the naturally occurring *Thunbergia*  $\Delta 6$  16:0-ACP desaturase (Schultz and Ohlrogge, 2001) and an engineered castor  $\Delta 9$  18:0-ACP desaturase with improved specificity toward 16:0-ACP (Cahoon and Shanklin, 2000) illustrate these complementary approaches. Recent efforts to produce unusual fatty acids have mainly focused on divergent forms of the  $\Delta 12$ -oleic acid desaturase (FAD2) that catalyse a wide range of fatty acid modifications (Cahoon and Kinney, 2005), including hydroxylation (Lu et al., 2006; Smith et al., 2003), epoxygenation, and double bond conjugation (Cahoon et al., 2006). A greater challenge has been the production of very-long-chain polyunsaturated fatty acids (VLCPUFA) like eicosapentaenoic acid (EPA, 20:5) and docosahexaenoic acid (DHA, 22:6) in oilseed crops (Cahoon et al., 2007). Engineering of EPA and DHA biosynthetic pathways in brassicaceae species has required the introduction of four and six genes, respectively, that have been isolated from several marine algal, thraustochytrid, mammalian, and fungal sources (Abadi et al., 2004; Robert et al., 2005; Wu et al., 2005). Despite some successes like laurate or EPA productions (for a review see Davies, 2007), the amounts of unusual fatty acids that accumulate in transgenic lines are often considerably less than those found in tissues from the natural sources of these fatty acids. This illustrates the weak efficiency of unusual fatty acid fluxes into TAGs in transgenic plants (Cahoon et al., 2007). The high levels of  $\beta$ -oxidation and glyoxylate enzyme activities found in developing transgenic seeds further restrict the production of high levels of unusual fatty acids (Larson et al., 2002; Moire et al., 2004). Improving our knowledge of fatty acid fluxes is now necessary to introduce, in addition to the enzymes necessary for the synthesis of unusual fatty acids, the enzymes that will assure a proper and efficient channelling of these fatty acids into TAGs (Graham et al., 2007).

#### ACKNOWLEDGEMENTS

Our work on seed maturation in *A. thaliana* is supported by grants from the G enoplatte GOP-Q3, TRIL-033 (P-009 Arabido-seed), and Plant-TFcode programs. S.B. and M.M. are CR-CNRS.

#### REFERENCES

- Abadi, A., Domergue, F., Bauer, J., Napier, J.A., Welti, R., Zahringer, U., Cirpus, P., Heinz, E. (2004) Biosynthesis of very-long-chain polyunsaturated fatty acids in transgenic oilseeds: constraints on their accumulation. *Plant Cell* **16**: 2734-2748.
- Abell, B.M., Holbrook, L.A., Abenes, M., Murphy, D.J., Hills, M.J., Moloney, M.M. (1997) Role of the proline knot motif in oleosin endoplasmic reticulum topology and oil body targeting. *Plant Cell* **9**: 1481-1493.
- Alban, C., Job, D., Douce, R. (2000) Biotin metabolism in plants. *Annu. Rev. Plant Physiol. Plant Mol. Biol.* **51**: 17-47.
- Alonso-Blanco, C., Blankestijn-de Vries, H., Hanhart, C.J., Koornneef, M. (1999) Natural allelic variation at seed size loci in relation to other life history traits of *Arabidopsis thaliana*. *Proc. Natl. Acad. Sci. USA* **96**: 4710-4717.
- Altenbach, S.B., Kuo, C.C., Staraci, L.C., Pearson, K.W., Wainwright, C., Georgescu, A. (1992) Accumulation of Brazil nut albumin in seeds of transgenic canola results in enhanced levels of seed protein methionine. *Plant Mol. Biol.* **18**: 235-245.
- Andre, C., Froehlich, J.E., Moll, M.R., Benning, C. (2007) A heteromeric plastidic pyruvate kinase complex involved in seed oil biosynthesis in *Arabidopsis*. *Plant Cell* **19**: 2006-2022.
- Arondel, V., Lemieux, B., Hwang, I., Gibson, S., Goodman, H.M., Somerville, C.R. (1992) Map-based cloning of a gene controlling omega-3 fatty acid desaturation. *Science* **358**: 1353-1355.
- Avonce, N., Leyman, B., Mascorro-Gallardo, J.O., Van Dijk, P., Thevelein, J.M., Iturriaga, G. (2004) The *Arabidopsis* trehalose-6-P synthase *AtTPS1* gene is a regulator of glucose, abscisic acid, and stress signalling. *Plant Physiol.* **136**: 3649-3659.
- Bailly, C., Audigier, C., Ladonne, F., Wagner, M.H., Coste, F., Corineau, F., C ome, D. (2001) Changes in oligosaccharide content and antioxidant enzyme activities in developing bean seeds as related to acquisition of drying tolerance and seed quality. *J. Exp. Bot.* **52**: 701-708.
- Barton, K.A., Thompson, J.F., Madison, J.T., Rosenthal, R., Jarvis, N.P., Beachy, R.N. (1982) The biosynthesis and processing of high molecular weight precursors of soybean glycin subunits. *J. Biol. Chem.* **257**: 6089-6095.
- Baud, S., Boutin, J.-P., Miquel, M., Lepiniec, L., Rochat C. (2002) An integrated overview of seed development in *Arabidopsis thaliana* ecotype WS. *Plant Physiol. Biochem.* **40**: 151-160.
- Baud, S., Guyon, V., Kronenberger, J., Wuill eme, S., Miquel, M., Caboche, M., Lepiniec, L., Rochat, C. (2003) Multifunctional acetyl-CoA carboxylase1 is essential for very long chain fatty acid elongation and embryo development in *Arabidopsis*. *Plant J.* **33**: 75-86.
- Baud, S., Bellec, Y., Miquel, M., Bellini, C., Caboche, M., Lepiniec, L., Faure, J.-D., Rochat, C. (2004a) *Gurke* and *Pasticcino3* mutants affected in embryo development are impaired in acetyl-CoA carboxylase. *EMBO Rep.* **5**: 515-520.
- Baud, S., Vaultier, M.-N., Rochat, C. (2004b) Structure and expression profile of the sucrose synthase multigene family in *Arabidopsis*. *J. Exp. Bot.* **55**: 397-409.
- Baud, S., Wuill eme, S., Lemoine, R., Kronenberger, J., Caboche, M., Lepiniec, L., Rochat, C. (2005) The *AtSUC5* sucrose transporter specifically expressed in the endosperm is involved in early seed development in *Arabidopsis*. *Plant J.* **43**: 824-836.
- Baud, S., Graham, I.A. (2006) A spatiotemporal analysis of enzymatic activities associated with carbon metabolism in wild-type and mutant embryos of *Arabidopsis* using *in situ* histochemistry. *Plant J.* **46**: 155-169.
- Baud, S., Santos Mendoza, M., To, A., Harscoet, E., Lepiniec, L., Dubreucq, B. (2007a) WRINKLED1 specifies the regulatory action of LEAFY COTYLEDON2 towards fatty acid metabolism during seed maturation in *Arabidopsis*. *Plant J.* **50**: 825-838.

- Baud, S., Wuillème, S., Dubreucq, B., de Almeida, A., Vuagnat, C., Lepiniec, L., Miquel, M., Rochat, C.** (2007b) Function of plastidial pyruvate kinase in seeds of *Arabidopsis thaliana*. *Plant J.* **52**: 405-419.
- Beisson, F., Koo, A.J.K., Ruuska, S., Schwender, J., Pollard, M., Thelen, J.J., Paddock, T., Salas, J.J., Savage, L., Milcamps, A., Mhaske, V.B., Cho, Y., Ohlrogge, J.B.** (2003) Arabidopsis genes involved in acyl lipid metabolism. A 2003 census of the candidates, a study of the distribution of expressed sequence tags in organs, and a web-based database. *Plant Physiol.* **132**: 681-697.
- Beisson, F., Li, Y., Bonaventure, G., Pollard, M., Ohlrogge, J.B.** (2007) The acyltransferase GPAT5 is required for the synthesis of suberin in seed coat and root of *Arabidopsis*. *Plant Cell* **19**: 351-368.
- Bentsink, L., Alonso-Blanco, C., Vreugdenhil, D., Tesnier, K., Groot, S.P.C., Koornneef, M.** (2000) Genetic analysis of seed-soluble oligosaccharides in relation to seed storability of *Arabidopsis*. *Plant Physiol.* **124**: 1595-1604.
- Berger, F., Grini, P.E., Schnittger, A.** (2006) Endosperm: an integrator of seed growth and development. *Curr. Opin. Plant Biol.* **9**: 664-670.
- Bewley, J.D.** (1997) Seed germination and dormancy. *Plant Cell.* **9**: 1055-1066.
- Bhalla, P.L.** (2006) Genetic engineering of wheat: current challenges and opportunities. *Trends Biotechnol.* **24**: 305-311.
- Bieniawska, Z., Barratt, D.H.P., Garlick, A.P., Thole, V., Kruger, N.J., Martin, C., Zrenner, R., Smith, A.M.** (2007) Analysis of the sucrose synthase gene family in *Arabidopsis*. *Plant J.* **49**: 810-828.
- Blacklock, B.J., Jaworski, J.G.** (2002) Studies into factors contributing to substrate specificity of membrane-bound 3-ketoacyl-CoA synthases. *Eur. J. Biochem.* **269**: 4789-4798.
- Blacklock, B.J., Jaworski, J.G.** (2006) Substrate specificity of Arabidopsis 3-ketoacyl-CoA synthases. *Biochem. Biophys. Res. Com.* **346**: 583-590.
- Bonaventure, G., Salas, J.J., Pollard, M.R., Ohlrogge, J.B.** (2003) Disruption of the *FATB* gene in *Arabidopsis* demonstrates an essential role of saturated fatty acids in plant growth. *Plant Cell* **15**: 1020-1033.
- Braybrook, S.A., Stone, S.L., Park, S., Bui, A.Q., Le, B.H., Fischer, R.L., Goldberg, R.B., Harada, J.J.** (2006) Genes directly regulated by *LEAFY COTYLEDON2* provide insight into the control of embryo maturation and somatic embryogenesis. *Proc. Natl. Acad. Sci. USA* **103**: 3468-3473.
- Broun, P., Gettner, S., Somerville, C.** (1999) Genetic engineering of plant lipids. *Annu. Rev. Nutr.* **19**: 197-216.
- Brown, A.P., Affleck, V., Fawcett, T., Slabas, A.R.** (2006) Tandem affinity purification tagging of fatty acid biosynthetic enzymes in *Synechocystis* sp. PCC6803 and *Arabidopsis thaliana*. *J. Exp. Bot.* **57**: 1563-1571.
- Browse, J., Somerville, C.** (1991) Glycerolipids synthesis: biochemistry and regulation. *Annu. Rev. Plant Physiol. Plant Mol. Biol.* **42**: 467-506.
- Buckhout, T., Thimm, O.** (2003) Insights into metabolism obtained from microarray analysis. *Curr. Opin. Plant Biol.* **6**: 288-296.
- Cahoon, E.B., Shanklin, J.** (2000) Substrate-dependent mutant complementation to select fatty acid desaturase variants for metabolic engineering of plant seed oils. *Proc. Natl. Acad. Sci. USA* **97**: 12350-12355.
- Cahoon, E.B., Shockey, J.M., Dietrich, C.R., Gidda, S.K., Mullen, R.T., Dyer, J.M.** (2007) Engineering oilseeds for sustainable production of industrial and nutritional feedstocks: solving bottlenecks in fatty acid flux. *Curr. Opin. Plant Biol.* **10**: 1-9.
- Cahoon, E.B., Kinney, A.J.** (2005) Production of vegetable oils with novel properties: using genomic tools to probe and manipulate fatty acid metabolism. *Eur. J. Lipid Sci. Technol.* **107**: 239-243.
- Cahoon, E.B., Dietrich, C.R., Meyer, K., Damude, H.G., Dyer, J.M., Kinney, A.J.** (2006) Conjugated fatty acids accumulate to high levels in phospholipids of metabolically engineered soybean and *Arabidopsis* seeds. *Phytochemistry* **67**: 1166-1176.
- Cao, Y.-Z., Huang, A.H.C.** (1986) Diacylglycerol acyltransferase in maturing oil seeds of maize and other species. *Plant Physiol.* **82**: 813-820.
- Cao, Y.-Z., Huang, A.H.C.** (1987) Acyl coenzyme A preference of diacylglycerol acyltransferase from the maturing seeds of *Cuphea*, maize, rapeseed, and canola. *Plant Physiol.* **84**: 762-765.
- Caspar, T., Huber, S.C., Somerville, C.** (1985) Alterations in growth, photosynthesis and respiration in a starch deficient mutant of *Arabidopsis thaliana* (L.) Heynh deficient in chloroplast phosphoglucomutase activity. *Plant Physiol.* **79**: 11-17.
- Casson, S.A., Lindsey, K.** (2006) The *turnip* mutant of *Arabidopsis* reveals that *LEAFY COTYLEDON1* expression mediates the effects of auxin and sugars to promote embryonic cell identity. *Plant Physiol.* **142**: 526-541.
- Cernac, A., Benning, C.** (2004) *WRINKLED1* encodes an AP2/EREB domain protein involved in the control of storage compound biosynthesis in *Arabidopsis*. *Plant J.* **40**: 575-585.
- Chopin, F., Orsel, M., Dorbe, M.-F., Chardon, F., Truong, H.-N., Miller, A.J., Krapp, A., Daniel-Vedele, F.** (2007) The *Arabidopsis* *ATNRT2.7* nitrate transporter controls nitrate content in seeds. *Plant Cell* **19**: 1590-1602.
- Craig, J., Barratt, P., Tatge, H., Déjardin, A., Gardner, C.D., Barber, L., Wang, T.L., Hedley, C.L., Martin, C., Smith, A.M.** (1999) Mutations at the *rug4* locus alter the carbon and nitrogen metabolism of pea plants through an effect on sucrose synthase. *Plant J.* **17**: 353-362.
- d'Andréa, S., Canonge, M., Beopoulos, A., Jolivet, P., Hartmann, M.A., Miquel, M., Lepiniec, L. and Chardot, T.** (2007) At5g50600 encodes a member of the short-chain dehydrogenase reductase superfamily with 11 $\beta$ - and 17 $\beta$ -hydroxysteroid dehydrogenase activities associated with *Arabidopsis thaliana* seed oil bodies. *Biochimie* **89**: 222-229.
- Da Silva, P.M.F.R., Eastmond, P.J., Hill, L.M., Smith, A.M., Rawsthorne, S.** (1997) Starch metabolism in developing embryos of oilseed rape. *Planta* **203**: 480-487.
- Davies, K.M.** (2007) Genetic modification of plant metabolism for human health benefits. *Mutation Res.* **622**: 122-137.
- De Clercq, A., Vandewiele, M., VanDamme, J., Guerche, P., Van Montagu, M., Vandekerckhove, J., Krebbers, E.** (1990) Stable accumulation of modified 2S albumin seed storage proteins with higher methionine contents in transgenic plants. *Plant Physiol.* **94**: 970-979.
- Dehesh, K., Jones, A., Knutzon, D.S., Voelker, T.A.** (1996) Production of high levels of 8:0 and 10:0 fatty acids in transgenic canola by overexpression of *Ch FatB2*, a thioesterase cDNA from *Cuphea hookeriana*. *Plant J.* **9**: 167-172.
- Dehesh, K., Tai, H., Edwards, P., Byrne, J., Jaworski, J.G.** (2001) Overexpression of 3-ketoacyl-acyl-carrier protein synthase IIIs in plants reduces the rate of lipid synthesis. *Plant Physiol.* **125**: 1103-1114.
- Dennis, D., Miernyk, J.** (1982) Compartmentation of non-photosynthetic carbohydrate metabolism. *Annu. Rev. Plant Physiol.* **33**: 27-50.
- D'Hondt, K., Van Damme, J., Van Den Bossche, C., Leejeerajumnean, S., De Rycke, R., Derksen, J., Vandekerckhove, J., Krebbers, E.** (1993) Studies of the role of the propeptides of the *Arabidopsis thaliana* 2S albumin. *Plant Physiol.* **102**: 425-433.
- Dörmann, P., Voelker, T.A., Ohlrogge, J.B.** (2000) Accumulation of palmitate in *Arabidopsis* mediated by the acyl-acyl carrier protein thioesterase *FATB1*. *Plant Physiol.* **123**: 637-643.
- Drea, S.C., Mould, R.M., Hibberd, J.M., Gray, J.C., Kavanagh, T.A.** (2001) Tissue-specific and developmental-specific expression of an *Arabidopsis thaliana* gene encoding the lipoamide dehydrogenase component of the plastid pyruvate dehydrogenase complex. *Plant Mol. Biol.* **46**: 705-715.
- Eastmond, P.J., Kolacna, L., Rawsthorne, S.** (1996) Photosynthesis by developing embryos of oilseed rape (*Brassica napus* L.). *J. Exp. Bot.* **47**: 1763-1769.
- Eastmond, P.J., Rawsthorne, S.** (2000) Coordinate changes in carbon partitioning and plastidial metabolism during the development of oilseed rape embryos. *Plant Physiol.* **122**: 767-774.
- Eastmond, P.J., van Dijken, A.J.H., Spielman, M., Kerr, A., Tissier, A.F., Dickinson, H.G., Jones, J.D.G., Smeekens, S.C., Graham, I.A.** (2002)

- Trehalose-6-phosphate synthase 1, which catalyses the first step in trehalose synthesis, is essential for *Arabidopsis* embryo maturation. *Plant J.* **29**: 225-235.
- Eastmond, P.J.** (2004) Glycerol-insensitive *Arabidopsis* mutants: *gl1* seedlings lack glycerol kinase, accumulate glycerol and are more resistant to abiotic stress. *Plant J.* **37**: 617-625.
- Ezcurra, I., Ellerstrom, M., Wycliffe, P., Stalberg, K., Rask, L.** (1999) Interaction between composite elements in the napA promoter: both the B-box ABA-responsive complex and the RY/G complex are necessary for seed-specific expression. *Plant Mol. Biol.* **40**: 699-709.
- Fait, A., Angelovici, R., Less, H., Ohad, I., Urbanczyk-Wochniak, E., Fernie, A.R., Galili, G.** (2006) Arabidopsis seed development and germination is associated with temporally distinct metabolic switches. *Plant Physiol.* **142**: 839-854.
- Falco, S.C., Guida, T., Locke, M., Mauvais, J., Sandres, C., Ward, R.T., Webber, P.** (1995) Transgenic canola and soybean seeds with increased lysine. *Biol. Technology* **13**: 577-582.
- Fatland, B.L., Ke, J., Anderson, M.D., Mentzen, W.I., Cui, L.W., Allred, C.C., Jonston, J.L., Nikolau, B.J., Wurtele, E.S.** (2002) Molecular characterization of a heteromeric ATP-citrate lyase that generates acetyl-coenzyme A in Arabidopsis. *Plant Physiol.* **130**: 740-756.
- Fatland, B.L., Nikolau, B.J., Wurtele, E.S.** (2005) Reverse genetic characterization of cytosolic acetyl-CoA generation by ATP-citrate lyase in Arabidopsis. *Plant Cell* **17**: 182-203.
- Finkelstein, R.R., Gampala, S.S., Rock, C.D.** (2002) Abscisic acid signalling in seeds and seedlings. *Plant Cell* **14**: Suppl., S15-45.
- Focks, N., Benning, C.** (1998) *Wrinkled 1*: a novel, low-seed-oil mutant of *Arabidopsis* with a deficiency in the seed-specific regulation of carbohydrate metabolism. *Plant Physiol.* **118**: 91-101.
- Frandsen, G.I., Mundy, J. and Tzen, T.C.** (2001) Oil bodies and their associated proteins, oleosin and caleosin. *Physiol. Plant.* **112**: 301-307.
- Fuji, K., Shimada, T., Takahashi, H., Tamura, K., Koumoto, Y., Utsumi, S., Nishizawa, K., Maruyama, N. and Hara-Nishimura, I.** (2007) *Arabidopsis* vacuolar sorting mutants (*green fluorescent seed*) can be identified efficiently by secretion of vacuolar-targeted green fluorescent protein in their seeds. *Plant Cell* **19**: 597-609.
- Fujiwara, T., Nambara, E., Yamagishi, K., Goto, D.B., Naito, S.** (2002) Storage proteins. In Somerville, C.R. and Meyerowitz, E.M. (eds), *The Arabidopsis Book*. American Society of Plant Physiologists, Rockville, pp11-12.
- Galili, G., Höfgen, R.** (2002) Metabolic engineering of amino acids and storage proteins in plants. *Metab. Eng.* **4**: 3-11.
- Garcia, D., Saingery, V., Chambrier, P., Mayer, U., Jürgens, G., Berger, F.** (2003) Arabidopsis *haiku* mutants reveal new controls of seed size by endosperm. *Plant Physiol.* **131**: 1661-1670.
- Garcia, D., Fitz Gerald, J.N., Berger, F.** (2005) Maternal control of integument cell elongation and zygotic control of endosperm growth are coordinated to determine seed size in Arabidopsis. *Plant Cell* **17**: 52-60.
- Gazzarrini, S., Tsuchiya, Y., Lumba, S., Okamoto, M., McCourt, P.** (2004) The transcription factor FUSCA3 controls developmental timing in Arabidopsis through the hormones gibberellin and abscisic acid. *Dev. Cell* **7**: 373-385.
- Ghanevati, M., Jaworski, J.G.** (2001) Active-site residues of a plant membrane-bound fatty acid elongase  $\beta$ -ketoacyl-CoA synthase, FAE1 KCS. *Biochem. Biophys. Acta* **1530**: 77-85.
- Gibon, Y., Vigeolas, H., Tiessen, A., Geigenberger, P., Stitt, M.** (2002) Sensitive and high throughput metabolite assays for inorganic pyrophosphate, ADPGlc, nucleotide phosphates, and glycolytic intermediates based on a novel enzymic cycling system. *Plant J.* **30**: 221-235.
- Gillespie, J., Rogers, S.W., Deery, M., Dupree, P., Rogers, J.C.** (2005) A unique family of proteins associated with internalized membranes in protein storage vacuoles of the Brassicaceae. *Plant J.* **41**: 429-441.
- Giraudat, J., Hauge, B.M., Valon, C., Smalle, J., Parcy, F., Goodman, H.M.** (1992) Isolation of the Arabidopsis *ABI3* gene by positional cloning. *Plant Cell* **4**: 1251-1261.
- Girke, T., Todd, J., Ruuska, S., White, J., Benning, C., Ohlrogge, J.** (2000) Microarray analysis of developing Arabidopsis seeds. *Plant Physiol.* **124**: 1570-1581.
- Goffman, F.D., Alonso, A.P., Schwender, J., Shachar-Hill, Y., Ohlrogge, J.B.** (2005) Light enables a very high efficiency of carbon storage in developing embryos of rapeseed. *Plant Physiol.* **138**: 2269-2279.
- Goldberg, R.B., de Paiva, G., Yadegari, R.** (1994) Plant embryogenesis: zygote to seed. *Science* **266**: 605-614.
- Gomez, L.D., Baud, S., Graham, I.A.** (2005) The role of trehalose-6-phosphate synthase in Arabidopsis embryo development. *Biochem. Soc. Trans.* **33**: 280-282.
- Gomez, L.D., Baud, S., Gilday, A., Li, Y., Graham, I.A.** (2006) Delayed embryo development in the *ARABIDOPSIS TREHALOSE-6-PHOSPHATE SYNTHASE 1* mutant is associated with altered cell wall structure, decreased cell division and starch accumulation. *Plant J.* **46**: 69-84.
- Graham, I.A., Larson, T., Napier, J.A.** (2007) Rational metabolic engineering of transgenic plants for biosynthesis of omega-3 polyunsaturates. *Curr. Opin. Biotechnol.* **18**: 142-147.
- Gruis, D.F., Selinger, D.A., Curran, J.M., Jung, R.** (2002) Redundant proteolytic mechanisms process seed storage proteins in the absence of seed-type members of the vacuolar processing enzyme family of cysteine proteases. *Plant Cell* **14**: 2863-2882.
- Gruis, D.F., Schulze, J., Jung, R.** (2004) Storage protein accumulation in the absence of the vacuolar processing enzyme family of cysteine proteases. *Plant Cell* **16**: 270-290.
- Guerche, P., Tire, C., Grossi, D.S.F., De Clercq, A., Van Montagu, M., Krebbers, E.** (1990) Differential expression of the Arabidopsis 2S albumin genes and the effect of increasing gene family size. *Plant Cell* **2**: 469-478.
- Gutierrez, L., Van Wuytswinkel, O., Castelain, M., Bellini, C.** (2007) Combined networks regulating seed maturation. *Trends Plant Sci.* **12**: 294-300.
- Harada, J.J.** (1997) **Seed maturation and control of germination.** In Larkins, B.A. and Vasil, I.K. (eds), *Cellular and molecular biology of plant seed development*. Kluwer academic publishers, Dordmund, pp 545-592.
- Hara-Nishimura, I., Inoue, K., Nishimura, M.** (1991) A unique vacuolar processing enzyme responsible for conversion of several proprotein precursors into the mature forms. *FEBS Lett.* **294**: 89-93.
- Hara-Nishimura, I., Shimada, T., Hiraiwa, N., Nishimura, M.** (1995) Vacuolar processing enzymes responsible for maturation of seed proteins. *J. Plant Physiol.* **145**: 632-640.
- Hawkins, D.J., Kridl, J.C.** (1998) Characterization of acyl-ACP thioesterases of mangosteen (*Garcinia mangostana*) seed and high levels of stearate production in transgenic canola. *Plant J.* **13**: 743-752.
- Hernandez-Sebastia, C., Marsolais, F., Saravitz, C., Israel, D., Dewey, R.E., Huber, S.C.** (2005) Free amino acid profiles suggest a possible role for asparagines in the control of storage-product accumulation in developing seeds of low- and high-protein soybean lines. *J. Exp. Bot.* **56**: 1951-1963.
- Hill, L.M., Morley-Smith, E.R., Rawsthorne, S.** (2003) Metabolism of sugars in the endosperm of developing seeds of oilseed rape. *Plant Physiol.* **131**: 228-236.
- Hillmer, S., Movafeghi, A., Robinson, D.G., Hinz, G.** (2001) Vacuolar storage proteins are sorted in the *cis*-cisternae of the pea cotyledon Golgi apparatus. *J Cell Biol.* **152**: 41-50.
- Hills, M.** (2004) Control of storgae-product synthesis in seeds. *Curr. Opin. Plant Biol.* **7**: 302-308.
- Hinz, G., Colanesi, S., Hillmer, S., Rogers, J.C., Robinson, D.G.** (2007) Localization of vacuolar transport receptors and cargo proteins in the Golgi apparatus of developing Arabidopsis embryos. *Traffic* **8**: 1452-1464.
- Hirawai, N., Kondo, M., Nishimura, M., Hara-Nishimura, I.** (1997) An aspartic endopeptidase is involved in the breakdown of propeptides of stor-

- age proteins in protein-storage vacuoles of plants. *Eur. J. Biochem.* **246**: 133-141.
- Hirner, B., Fischer, W.N., Rentsch, D., Kwart, M., Frommer, W.B.** (1998) Developmental control of H<sup>+</sup>/amino acid permease gene expression during seed development of Arabidopsis. *Plant J.* **14**: 535-544.
- Hobbs, D.H., Lu, C., Hills, M.J.** (1999) Cloning of a cDNA encoding diacylglycerol acyltransferase from *Arabidopsis thaliana* and its functional expression. *FEBS Lett.* **452**: 145-149.
- Hoekstra, F.A., Golovina, E.A., Buitink, J.** (2001) Mechanisms of plant desiccation tolerance. *Trends Plant Sci.* **6**: 431-438.
- Huang, A.H.C.** (1992) Oilbodies and oleosins in seeds. *Annu. Rev. Plant Physiol. Plant Mol. Biol.* **43**: 177-200.
- Huang, T.** (1975) Enzymes of glycerol metabolism in the storage tissues of fatty seedlings. *Plant Physiol.* **55**: 555-558.
- Jain, R.K., Coffey, M., Lai, K., Kumar, A., MacKenzie, S.L.** (2000) Enhancement of seed oil content by expression of glycerol-3-phosphate acyltransferase genes. *Biochem. Soc. Trans.* **28**: 958-961.
- Jako, C., Kumar, A., Wei, Y., Zou, J., Barton, D.L., Giblin, E.M., Covello, P.S., Taylor, D.C.** (2001) Seed-specific over-expression of an Arabidopsis cDNA encoding a diacylglycerol acyltransferase enhances seed oil content and seed weight. *Plant Physiol.* **126**: 861-874.
- James, D.W., Jr., Lim, E., Keller, J., Plooy, I., Ralston, E., Dooner, H.K.** (1995) Directed tagging of the Arabidopsis FATTY ACID ELONGATION (FAE1) gene with maize transposon Activator. *Plant Cell* **7**: 309-319.
- Jaworski, J., Cahoon, E.B.** (2003) Industrial oils from transgenic plants. *Curr. Opin. Plant Biol.* **6**: 178-184.
- Jenik, P.D., Gillmor, C.S., Lokuwicz, W.** (2007) Embryonic patterning in *Arabidopsis thaliana*. *Annu. Rev. Cell Dev. Biol.* **23**: 207-236.
- Jofuku, K.D., Omidyar, P.K., Gee, Z., Okamoto, J.K.** (2005) Control of seed mass and seed yield by the floral homeotic gene *APETALA2*. *Proc. Natl. Acad. Sci. USA* **102**: 3117-2122.
- Johnston, M.L., Luethy, M.H., Miernyk, J.A., Randall, D.D.** (1997) Cloning and molecular analyses of the *Arabidopsis thaliana* plastid pyruvate dehydrogenase subunits. *Biochim. Biophys. Acta* **1321**: 200-206.
- Jolivet, P., Roux, E., d'Andrea, S., Davature, M., Negroni, L., Zivy, M. and Chardot, T.** (2004) Protein composition of oil bodies in Arabidopsis thaliana ecotype WS. *Plant Physiol. Biochem.* **42**: 501-509.
- Jones, A., Davies, H.M., Voelker, T.A.** (1995) Palmitoyl-acyl carrier protein (ACP) thioesterase and the evolutionary origin of plant acyl-ACP thioesterases. *Plant Cell* **7**: 359-371.
- Junker, B.H., Lonien, J., Heady, L.E., Rogers, A., Schwender, J.** (2007) Parallel determination of enzyme activities and *in vivo* fluxes in *Brassica napus* embryos grown on organic or inorganic nitrogen source. *Phytochemistry* **68**: 2232-2242.
- Jürgens, G.** (2001) Apical-basal pattern formation in Arabidopsis embryogenesis. *EMBO J.* **20**: 3609-3616.
- Kang, F., Rawsthorne, S.** (1994) Starch and fatty acid synthesis in plastids from developing embryos of oilseed rape (*Brassica napus* L.). *Plant J.* **6**: 795-805.
- Kagaya, Y., Toyoshima, R., Okuda, R., Usui, H., Yamamoto, A., Hattori, T.** (2005) LEAFY COTYLEDON1 controls seed storage protein genes through its regulation of FUSCA3 and ABSCISIC ACID INSENSITIVE3. *Plant Cell Physiol.* **46**: 399-406.
- Katavic, V., Friesen, W., Barton, D.L., Gossen, K.K., Giblin, E.M., Luciw, T., An, J., Zou, J.-T., MacKenzie, S.L., Keller, W.A., Males, D., Taylor, D.C.** (2001) Improving erucic acid content in rapeseed through biotechnology: What can the Arabidopsis FAE1 and the yeast CLC1-1 genes contribute. *Crop Sci.* **41**: 739-747.
- Ke, J., Wen, T.-N., Nikolau, B.J., Wurtele, E.S.** (2000) Coordinated regulation of the nuclear and plastidic genes coding for the subunits of the heteromeric acetyl-coenzyme A carboxylase. *Plant Physiol.* **122**: 1057-1071.
- Kennedy, E.P.** (1961) Biosynthesis of complex lipids. *Fed. Proc. Am. Soc. Exp. Biol.* **72**: 869-879.
- Kim, I., Kobayashi, K., Cho, E., Zambryski, P.C.** (2005a) Subdomains for transport via plasmodesmata corresponding to the apical-basal axis are established during Arabidopsis embryogenesis. *Proc. Natl. Acad. Sci. USA* **102**: 11945-11950.
- Kim, H.U., Li, Y., Huang, A.H.** (2005b) Ubiquitous and endoplasmic reticulum-located lysophosphatidyl acyltransferase, LPAT2, is essential for female but not male gametophyte development in Arabidopsis. *Plant Cell*, **17**: 1073-1089.
- Kim, I., Zambryski, P.** (2005) Cell-to-cell communication via plasmodesmata during Arabidopsis embryogenesis. *Curr. Opin. Plant Biol.* **8**: 593-599.
- Kim, S.A., Punshon, T., Lanzirrotti, A., Li, L., Alonso, J.M., Ecker, J.R., Kaplan, J., Gueriot, M.L.** (2006) Localization of iron in Arabidopsis seed requires the vacuolar membrane transporter VIT1. *Science* **314**: 1295-1298.
- King, S.P., Badger, M.R., Furbank, R.T.** (1998) CO<sub>2</sub> refixation characteristics of developing canola seeds and silique wall. *Aust. J. Plant Physiol.* **25**: 377-386.
- Kinney, A.J.** (2006) Metabolic engineering in plants for human health and nutrition. *Curr. Opin. Biotech.* **17**: 1-9.
- Kinoshita, T., Nishimura, M., Hara-Nishimura, I.** (1995a) The sequence and expression of the gamma-VPE gene, one member of a family of three genes for vacuolar processing enzymes in Arabidopsis thaliana. *Plant Cell Physiol.* **36**: 1555-1562.
- Kinoshita, T., Nishimura, M., Hara-Nishimura, I.** (1995b) Homologues of a vacuolar processing enzyme that are expressed in different organs in Arabidopsis thaliana. *Plant Mol. Biol.* **29**: 81-89.
- Kinoshita, T., Yamada, K., Hiraiwa, N., Kondo, M., Nishimura, M., Hara-Nishimura, I.** (1999) Vacuolar processing enzyme is up-regulated in the lytic vacuoles of vegetative tissues during senescence and under various stressed conditions. *Plant J.* **19**: 43-53.
- Kirsch, T., Gerber, D.W., Byerrum, R.U., Tolbert, N.E.** (1992) Plant dihydroxyacetone phosphate reductases – purification, characterization, and localization. *Plant Physiol.* **100**: 352-359.
- Knutzon, D.S., Thompson, G.A., Radke, S.E., Johnson, W.B., Knauf, V.C., Kridl, J.C.** (1992) Modification of Brassica seed oil by antisense expression of a stearyl-acyl carrier protein desaturase gene. *Proc. Natl. Acad. Sci. USA* **89**: 2624-2628.
- Knutzon, D.S., Hayes, T.R., Wyrick, A., Xiong, H., Davies, H.M., Voelker, T.A.** (1999) Lysophosphatidic acid acyltransferase from coconut endosperm mediates the insertion of laurate at the sn-2 position of triacylglycerols in lauric rapeseed oil and can increase total laurate levels. *Plant Physiol.* **120**: 739-746.
- Kohlwein, S.D., Eder, S., Oh, C.S., Martin, C.E., Gable, K., Bacikova, D., Dunn, T.** (2001) Tsc13p is required for fatty acid elongation and localizes to a novel structure at the nuclear-vacuolar interface in *Saccharomyces cerevisiae*. *Mol. Cell. Biol.* **21**: 109-125.
- Konishi, T., Sasaki, Y.** (1994) Compartmentalization of two forms of acetyl-CoA carboxylase in plants and the origin of their tolerance toward herbicides. *Proc. Natl. Acad. Sci. USA* **91**: 3591-3601.
- Konishi, T., Shinohara, K., Yamada, K., Sasaki, Y.** (1996) Acetyl-CoA carboxylase in higher plants: most plants other than gramineae have both the prokaryotic and the eukaryotic forms of this enzyme. *Plant Cell Physiol.* **37**, 117-122.
- Krebbbers, I., Herdies, L., De Clercq, A., Seurinck, J., Leemans, J., Van Damme, J., Sequra, M., Gheysen, G., Van Montagu, M., Vendekerckhove, J.** (1988) Determination of the processing sites of an Arabidopsis 2S albumin and characterization of the complete gene family. *Plant Physiol.* **87**: 859-866.
- Kroj, T., Savino, G., Valon, C., Giraudat, J., Parcy, F.** (2003) Regulation of storage protein gene expression in Arabidopsis. *Development* **130**: 6065-6073.
- Kuang, A., Crispi, M., Musgrave, M.E.** (1998) Control of seed development in Arabidopsis thaliana by atmospheric oxygen. *Plant Cell Environ.* **21**: 71-78.

- Kubis, S.E., Pike, M.J., Everett, C.J., Hill, L.M., Rawsthorne, S.** (2004) The import of phosphoenolpyruvate by plastids from developing embryos of oilseed rape, *Brassica napus* (L.), and its potential as a substrate for fatty acid synthesis. *J. Exp. Bot.* **402**: 1455-1462.
- Kurup, S., Jones, H.D., Holdsworth, M.J.** (2000) Interactions of the developmental regulator ABI3 with proteins identified from developing Arabidopsis seeds. *Plant J.* **21**: 143-155.
- Lam, H.-N., Wong, P., Chan, H.-K., Yam, K.-M., Chen, L., Chow, C.-M., Coruzzi, G.M.** (2003) Overexpression of the *ASN1* gene enhances nitrogen status in seeds of Arabidopsis. *Plant Physiol.* **132**: 926-935.
- Lanquar, V., Lelievre, F., Bolte, S., Hames, C., Alcon, C., Neumann, D., Vansuyt, G., Curie, C., Schroder, A., Kramer, U., Barbier-Brygoo, H., Thomine, S.** (2005) Mobilization of vacuolar iron by AtNRAMP3 and AtNRAMP4 is essential for seed germination on low iron. *EMBO J.* **24**: 4041-4051.
- Lara, P., Onate-Sanchez, L., Abraham, Z., Ferrandiz, C., Diaz, I., Carbonero, P., Vicente-Carbajosa, J.** (2003) Synergistic activation of seed storage protein gene expression in Arabidopsis by ABI3 and two bZIPs related to OPAQUE2. *J. Biol. Chem.* **278**: 21003-21011.
- Larson, T.R., Edgell, T., Byrne, J., Dehesh, K., Graham, I.A.** (2002) Acyl CoA profiles of transgenic plants that accumulate medium-chain fatty acids indicate inefficient storage lipid synthesis in developing oilseeds. *Plant J.* **32**: 519-527.
- Lee, H., Fischer, R.L., Goldberg, R.B., Harada, J.J.** (2003) Arabidopsis LEAFY COTYLEDON1 represents a functionally specialized subunit of CCAAT binding transcription factor. *Proc. Natl. Acad. Sci. USA* **100**: 2152-2156.
- Leon, P., Sheen, J.** (2003) Sugar and hormone connections. *Trends Plant Sci.* **8**: 110-116.
- Lepiniec, L., Debeaujon, I., Routaboul, J.-M., Baudry, A., Pourcel, L., Nesi, N., Caboche, M.** (2006) Genetics and biochemistry of seed flavonoids. *Annu. Rev. Plant Biol.* **57**: 405-430.
- Lepince, O., Bronchart, R., Deltour, R.** (1990) Changes in starch and soluble sugars in relation to the acquisition of desiccation tolerance during maturation of *Brassica campestris* seed. *Plant Cell Environ.* **13**: 539-546.
- Lepince, O., van Aelst, A.C., Pritchard, H.W. and Murphy, D.J.** (1998) Oleosins prevent oil-body coalescence during seed imbibition as suggested by a low-temperature scanning electron microscope study of desiccation-tolerant and -sensitive oilseeds. *Planta* **204**: 109-119.
- Li, F., Asami, T., Wu, X., Tsang, E.W.T. and Cutler, A.** (2007a) A putative hydroxysteroid dehydrogenase involved in regulating plant growth and development. *Plant Physiol.* **145**: 87-97.
- Li, Q., Wang, B.-C., Xu, Y., Zhu, Y.-X.** (2007b) Systematic studies of 12S seed storage protein accumulation and degradation patterns during Arabidopsis seed maturation and early seedling germination stages. *J. Biochem. Mol. Biol.* **40**: 373-381.
- Liedvogel, B.** (1986) Acetyl-CoA and isopentenylpyrophosphate as lipid precursors in plant cells: Biosynthesis and compartmentation. *J. Plant Physiol.* **124**: 211-222.
- Lin, M., Behal, R., Oliver, D.J.** (2003) Disruption of *pIE2*, the gene for the E2 subunit of the plastid pyruvate dehydrogenase complex, in Arabidopsis causes an early embryo lethal phenotype. *Plant Mol. Biol.* **52**: 865-872.
- Lotan, T., Ohto, M., Yee, K.M., West, M.A., Lo, R., Kwong, R.W., Yamagashi, K., Fischer, R.L., Goldberg, R.B., Harada, J.J.** (1998) Arabidopsis LEAFY COTYLEDON1 is sufficient to induce embryo development in vegetative cells. *Cell* **93**: 1195-1205.
- Lott, J.N.A., Greenwood, J.S., Batten, G.D.** (1995) Mechanisms and regulation of mineral nutrient storage during seed development. In Kigel, J. and Galili, G. (eds), *Seed Development and Germination*. Marcel Dekker, New-York, pp 215-235.
- Lu, C., Fulda, M., Wallis, J.G., Browse, J.** (2006) A high-throughput screen for genes from castor that boost hydroxy fatty acid accumulation in seed oils of transgenic Arabidopsis. *Plant J.* **45**: 847-856.
- Luerssen, H., Kirik, V., Herrmann, P., Misera, S.** (1998) *FUSCA3* encodes a protein with a conserved VP1/ABI3-like B3 domain which is of functional importance for the regulation of seed maturation in Arabidopsis thaliana. *Plant J.* **15**: 755-764.
- Luo, M., Dennis, E.S., Berger, F., Peacock, W.J., Chaudhury, A.** (2005) *MINISEED3 (MINI3)*, a WRKY family gene, and *HAIKU2 (IKU2)*, a leucine-rich repeat (LRR) KINASE gene, are regulators of seed size in Arabidopsis. *Proc. Natl. Acad. Sci. USA* **102**: 17531-17536.
- Lutziger, I., Oliver, D.J.** (2000) Molecular evidence of a unique lipoamide dehydrogenase in plastids: analysis of plastidic lipoamide dehydrogenase from Arabidopsis thaliana. *FEBS Lett.* **484**: 12-16.
- Mansfield, S.G., Briarty, L.G.** (1992) Cotyledon cell-development in Arabidopsis thaliana during reserve deposition. *Can. J. Bot.* **70**: 151-164.
- Masaki, T., Mitsui, N., Tsukagoshi, H., Nishii, T., Morikami, A., Nakamura, K.** (2005) ACTIVATOR of Spo<sup>min</sup>::LUC1/WRINKLED1 of Arabidopsis thaliana transactivates sugar-inducible promoters. *Plant Cell Physiol.* **46**: 547-556.
- Mazur, B., Krebbers, E., Tingey, S.** (1999) Gene discovery and product development for grain quality traits. *Science* **285**: 372-375.
- McCartney, A.W., Dyer, J.M., Dhanoa, P.K., Kim, P.K., Andrews, D.W., McNew, J.A., Mullen, R.T.** (2004) Membrane-bound fatty acid desaturases are inserted co-translationally into the ER and contain different ER retrieval motifs at their carboxy termini. *Plant J.* **37**: 156-173.
- Meinke, D.W., Franzmann, L.H., Nickle, T.C., Yeung, E.C.** (1994) Leafy cotyledon mutants of Arabidopsis. *Plant Cell* **6**: 1049-1064.
- Meyer, S., Lauterbach, C., Niedermeier, M., Barth, I., Sjolund, R.D., Sauer, N.** (2004) Wounding enhances expression of AtSUC3, a sucrose transporter from Arabidopsis sieve elements and sink tissues. *Plant Physiol.* **134**: 684-693.
- Millar, A.A., Kunst, L.** (1997) Very-long-chain fatty acid biosynthesis is controlled through the expression and specificity of the condensing enzyme. *Plant J.* **12**: 121-131.
- Millar, A.A., Kunst, L.** (1999) The natural genetic variation of the fatty-acyl composition of seed oils in different ecotypes of Arabidopsis thaliana. *Phytochemistry* **52**: 1029-1033.
- Miquel, M., Browse, J.** (1995) Lipid biosynthesis in developing seeds. In J. Kigel and G. Galili (eds), *Seed development and germination*. Marcel Dekker, New York, pp169-193.
- Miquel, M., Cassagne, C., Browse, J.** (1998) A new class of Arabidopsis mutants with reduced hexadecatrienoic acid fatty acid levels. *Plant Physiol.* **117**: 923-930.
- Moire, L., Rezzonico, E., Goepfert, S., Poirier, Y.** (2004) Impact of unusual fatty acid synthesis on futile cycle through beta-oxidation and on gene expression in transgenic plants. *Plant Physiol.* **134**: 432-442.
- Monke, G., Altschmied, L., Tewes, A., Reidt, W., Mock, H.P., Baumlein, H., Conrad, U.** (2004) Seed-specific transcription factors ABI3 and FUS3: molecular interaction with DNA. *Planta* **219**: 158-166.
- Mou, Z., He, Y., Dai, Y., Liu, X., Li, J.** (2000) Deficiency in fatty acid synthase leads to premature cell death and dramatic alterations in plant morphology. *Plant Cell* **12**: 405-417.
- Muntz, K.** (1998) Deposition of storage proteins. *Plant Mol. Biol.* **38**, 77-99.
- Murphy, D.J. and Vance, J.** (1999) Mechanisms of lipid-body formation. *Trends Biochem. Sci.* **24**: 109-115.
- Nakashima, K., Fujita, Y., Katsura, K., Maruyama, K., Narasuka, Y., Seki, M., Shinozaki, K., Yamaguchi-Shinozaki, K.** (2006) Transcriptional regulation of ABI3- and ABA-responsive genes including RD29B and RD29A in seeds, germinating embryos, and seedlings of Arabidopsis. *Plant Mol. Biol.* **60**: 51-68.
- Nandi, A., Welti, R., Shah, J.** (2004) The Arabidopsis thaliana dihydroxyacetone phosphate reductase gene SUPPRESSOR OF FATTY ACID DESATURASE DEFICIENCY1 is required for glycerolipid metabolism and for the activation of systemic acquired resistance. *Plant Cell* **16**: 465-477.
- Nambara, E., Marion-Poll, A.** (2005) Abscisic acid biosynthesis and catabolism. *Annu. Rev. Plant Biol.* **56**: 165-185.

- Neuhaus, H.E., Emes, M.J.** (2000) Nonphotosynthetic metabolism in plastids. *Annu. Rev. Plant Physiol. Plant Mol. Biol.* **51**: 111-140.
- Norton, G., Harris, J.F.** (1975) Compositional changes in developing rape seed (*Brassica napus* L.). *Planta* **123**: 163-174.
- Ohto, M.A., Fischer, R.L., Goldberg, R.B., Nakamura, K., Harada, J.J.** (2005) Control of seed mass by APETALA2. *Proc. Natl. Acad. Sci. USA* **102**: 3123-3128.
- Okuley, J., Lightner, J., Feldmann, K., Yadav, N., Lark, E., Browse, J.** (1994) Arabidopsis FAD2 gene encodes the enzyme that is essential for polyunsaturated lipid synthesis. *Plant Cell* **6**: 147-158.
- Okumoto, S., Schmidt, R., Tegeder, M., Fischer, W.N., Rentsch, D., Frommer, W.B., Koch, W.** (2002) High affinity amino acid transporters specifically expressed in xylem parenchyma and developing seeds of Arabidopsis. *J. Biol. Chem.* **277**: 45338-45346.
- Olivsson, P., Heinzerling, O., Hillmer, S., Hinz, G., Tze, Y.C., Jiang, L.W., Robinson, D.G.** (2006) Plant retromer, localized to the prevacuolar compartment and microvesicles in Arabidopsis, may interact with vacuolar sorting receptors. *Plant Cell* **18**: 1239-1252.
- Olsen, O.A.** (2001) Endosperm development: cellularization and cell fate specification. *Annu. Rev. Plant Physiol. Plant Mol. Biol.* **52**, 233-267.
- O'Neill, C.M., Gill, S., Hobbs, D., Morgan, C., Bancroft, I.** (2003) Natural variation for seed oil composition in *Arabidopsis thaliana*. *Phytochemistry* **64**: 1077-1090.
- Otegui, M.S., Capp, R., Staehelin, L.A.** (2002) Developing seeds of Arabidopsis store different minerals in two types of vacuoles and in the endoplasmic reticulum. *Plant Cell* **14**: 1311-1327.
- Otegui, M.S., Herder, R., Schulze, J., Jung, R., Staehelin, L.A.** (2006) The proteolytic processing of seed storage proteins in Arabidopsis embryo cells starts in the multivesicular bodies. *Plant Cell* **18**: 2567-2581.
- Pang, P.P., Pruitt, R.E., Meyerowitz, E.M.** (1988) Molecular cloning, genome organization, expression and evolution of 12S seed storage protein genes of *Arabidopsis thaliana*. *Plant Mol. Biol.* **11**: 805-820.
- Park, M., Lee, D., Lee, G.J., Hwang, I.** (2005) AtRMR1 functions as a cargo receptor for protein trafficking to the protein storage vacuole. *J. Cell Biol.* **170**: 757-767.
- Patrick, J.W., Offler, C.E., Wang, X.D.** (1995) Cellular pathway of photosynthate transport in coats of developing seed of *Vicia faba* L. and *Phaseolus vulgaris* L. I. Extent of transport through the coat symplast. *J. Exp. Bot.* **46**: 35-47.
- Patrick, J.W., Offler, C.E.** (2001) Compartmentation of transport and transfer events in developing seeds. *J. Exp. Bot.* **52**: 551-564.
- Penfield, S., Rylott, E.L., Gilday, A.D., Graham, S., Larson, T.R., Graham, I.A.** (2004) Reserve mobilization in the Arabidopsis endosperm fuels hypocotyl elongation in the dark, is independent of abscisic acid, and requires PHOSPHOENOLPYRUVATE CARBOXYKINASE1. *Plant Cell* **16**: 2705-2718.
- Periappuram, C., Steinhauer, L., Barton, D.L., Taylor, D.C., Chatson, B., Zou, J.** (2000) The plastidic phosphoglucomutase from Arabidopsis. A reversible enzyme reaction with an important role in metabolic control. *Plant Physiol.* **122**: 1193-1199.
- Perry, H.J., Bligny, R., Gout, E., Harwood, J.L.** (1999) Changes in Kennedy pathway intermediates associated with increased triacylglycerol synthesis in oil-seed rape. *Phytochemistry* **52**: 799-804.
- Pidkowich, M.S., Nguyen, H.T., Heilmann, I., Ischebeck, T., Shanklin, J.** (2007) Modulating seed  $\beta$ -ketoacyl-acyl carrier protein synthase II level converts the composition of a temperate seed oil to that of a palm-like tropical oil. *Proc. Natl. Acad. Sci. USA* **104**: 4742-4747.
- Phillips, J., Artsaenko, O., Fiedler, U., Horstmann, C., Mock, H.P., Muntz, K., Conrad, U.** (1997) Seed-specific immunomodulation of abscisic acid activity induces a developmental switch. *EMBO J.* **16**: 4489-4496.
- Porterfield, D.M., Kuang, A., Smith, P.J., Crispi, M.L., Musgrave, M.E.** (1999) Oxygen-depleted zones inside reproductive structures of Brassicaceae: implications for oxygen control of seed development. *Can. J. Bot.* **77**: 1439-1446.
- Poxleitner, M., Rogers, S.W., Samuels, A.L., Browse, J. and Rogers, J.C.** (2006) A role for caleosin in degradation of oil-body storage lipid during seed germination. *Plant J.* **47**: 917-933.
- Randall, D.D., Miernyk, J.A.** (1990) The mitochondrial puruvate dehydrogenase complex. In Lea P.J. (ed), *Methods in plant biochemistry*, vol 3: enzymes of primary metabolism. Academic press, London, pp175-192.
- Rawsthorne, S.** (2002) Carbon flux and fatty acid synthesis in plants. *Prog. Lipid Res.* **41**: 182-196.
- Raz, V., Bergervoet, J.H.W., Koornneef, M.** (2001) Sequential steps for developmental arrest in *Arabidopsis* seeds. *Development* **128**: 243-252.
- Reidt, W., Wohlfarth, T., Ellerstrom, M., Czihal, A., Tewes, A., Ezcurra, I., Rask, L., Baumlein, H.** (2000) Gene regulation during late embryogenesis: the RY motif of maturation-specific gene promoters is a direct target of the FUS3 gene product. *Plant J.* **21**: 401-408.
- Robenek, H., Hofnagel, O., Buers, I., Robenek, M.J., Troyer, D. and Severs, N.J.** (2006) Adipophilin-enriched domains in the ER membrane are sites of lipid droplets biogenesis. *J. Cell Sci.* **119**: 4215-4224.
- Robenek, M.J., Severs, N.J., Schlattmann, K., Plenz, G., Zimmer, K.P., Troyer, D. and Robenek, H.** (2004) Lipids partition caveolin-1 from ER membranes into lipid droplets: updating the model of lipid droplet biogenesis. *FASEB J.* **18**: 866-868.
- Robert, S.S., Singh, S.P., Zhou, X.-R., Petrie, J.R., Blackburn, S.I., Mansour, P.M., Nichols, P.D., Liu, Q., Green, A.G.** (2005) Metabolic engineering of Arabidopsis to produce nutritionally important DHA in seed oil. *Func. Plant Biol.* **32**: 473-479.
- Roscoe, T.J., Lessire, R., Puyaubert, J., Renard, M., Delseny, M.** (2001) Mutations in the fatty acid elongation 1 gene are associated with a loss of beta-ketoacyl-CoA synthase activity in low erucic acid rapeseed. *FEBS Lett.* **492**: 107-111.
- Rolletschek, H., Borisjuk, L., Koschorreck, M., Wobus, U., Weber, H.** (2002) Legume embryos develop in hypoxic environment. *J. Exp. Bot.* **53**: 1099-1107.
- Rolletschek, H., Hosein, F., Miranda, M., Heim, U., Götz, K.P., Schlereth, A., Borisjuk, L., Saalbach, I., Wobus, U., Weber, H.** (2005) Ectopic expression of an amino acid transporter (VfAAP1) in seeds of *Vicia narbonensis* and pea increases storage proteins. *Plant Physiol.* **137**: 1236-1249.
- Rossak, M., Smith, M., Kunst, L.** (2001) Expression of the *FAE1* gene and *FAE1* promoter activity in developing seeds of *Arabidopsis thaliana*. *Plant Mol. Biol.* **46**: 717-725.
- Routaboul, J.-M., Benning, C., Bechtold, N., Caboche, M., Lepiniec, L.** (1999) The *TAG1* locus of *Arabidopsis* encodes for a diacylglycerol acyltransferase. *Plant Physiol. Biochem.* **37**: 831-840.
- Ruuska, S.A., Girke, T., Benning, C., Ohlrogge, J.** (2002) Contrapuntal networks of gene expression during Arabidopsis seed filling. *Plant Cell*, **14**: 1191-1206.
- Ruuska, S.A., Schwender, J., Ohlrogge, J.** (2004) The capacity of green oilseeds to utilize photosynthesis to drive biosynthetic processes. *Plant Physiol.* **136**: 2700-2709.
- Sadava, D., Moore, K.** (1987) Glycerol metabolism in higher-plants – glycerol kinase. *Biochem. Biophys. Res. Commun.* **143**: 977-983.
- Salas, J.J., Ohlrogge, J.B.** (2002) Characterization of substrate specificity of plant FatA and FatB acyl-ACP thioesterases. *Arch. Biochem. Biophys.* **403**: 25-34.
- Santos Mendoza, M., Dubreucq, B., Miquel, M., Caboche, M., Lepiniec, L.** (2005) LEAFY COTYLEDON2 activation is sufficient to trigger the accumulation of oil and seed specific mRNAs in Arabidopsis leaves. *FEBS Lett.* **579**: 4666-4670.
- Santos Mendoza, M., Dubreucq, B., Baud, S., Parcy, F., Caboche, M., Lepiniec, L.** (2008) Deciphering gene regulatory networks that control seed development and maturation in *Arabidopsis*. *Plant J.* **50**: 825-838.
- Sauer, N.** (2007) Molecular physiology of higher plant sucrose transporters. *FEBS Lett.* **581**: 2309-2317.

- Schmidt, R., Stransky, H., Koch, W.** (2007) The amino acid permease AAP8 is important for early seed development in *Arabidopsis thaliana*. *Planta* **226**: 805-813.
- Schultz, D.J., Ohlrogge, J.B.** (2001) Metabolic engineering of fatty acid biosynthesis. In Kuo, T.M. and Gardner, H.W. (eds), *Lipid biotechnology*. Marcel Dekker, New-York, pp1-25.
- Schwender, J., Ohlrogge, J.B.** (2002) Probing *in vivo* metabolism by stable isotope labelling of storage lipids and proteins in developing *Brassica napus* embryos. *Plant Physiol.* **130**: 347-361.
- Schwender, J., Ohlrogge, J., Shachar-Hill, Y.** (2003) A flux model of glycolysis and the oxidative pentosephosphate pathway in developing *Brassica napus* embryos. *J. Biol. Chem.* **32**: 29442-29453.
- Schwender, J., Goffman, F., Ohlrogge, J., Shachar-Hill, Y.** (2004a) Rubisco without the Calvin cycle improves the carbon efficiency of developing green seeds. *Nature* **432**: 779-782.
- Schwender, J., Ohlrogge, J., Shachar-Hill, Y.** (2004b) Understanding flux in plant metabolic networks. *Curr. Opin. Plant Biol.* **7**: 309-317.
- Schwender, J., Shachar-Hill, Y., Ohlrogge, J.** (2006) Mitochondrial metabolism in developing embryos of *Brassica napus*. *J. Biol. Chem.* **45**: 34040-34047.
- Sebei, K., Ouerghi, Z., Kallel, H., Boukhchina, S.** (2006) Evolution of phosphoenolpyruvate carboxylase activity and lipid content during seed maturation of two spring rapeseed cultivars (*Brassica napus* L.). *C.R. Biologies* **329**: 719-725.
- Sharma, N., Phutela, A., Malhotra, S.P., Sigh, R.** (2001) Purification and characterization of dihydroxyacetone phosphate reductase from immature seeds of *Brassica campestris* L. *Plant Sci.* **160**: 603-610.
- Shewry, P.R.** (2007) Improving the protein content and composition of cereal grain. *J. Cereal Sci.* **46**: 239-250
- Shimada, T., Fuji, K., Tamura, K., Kondo, M., Nishimura, M., Hara-Nishimura, I.** (2003) Vacuolar sorting receptor for seed storage proteins in *Arabidopsis thaliana*. *Proc. Natl. Acad. Sci. USA* **100**: 16095-16100.
- Shimada, T., Koumoto, Y., Li, L., Kondo, M., Nishimura, M., Hara-Nishimura, I.** (2006) AtVPS29, a putative component of a retromer complex, is required for the efficient sorting of seed storage proteins. *Plant Cell Physiol.* **47**: 1187-1194.
- Shockey, J.M., Gidda, S.K., Chapital, D.C., Kuan, J.C., Dhanoa, P.K., Bland, J.M., Rothstein, S.J., Mullen, R.T., Dyer, J.M.** (2006) Tung tree DGAT1 and DGAT2 have nonredundant functions in triacylglycerol biosynthesis and are localized to different subdomains of the endoplasmic reticulum. *Plant Cell* **18**: 2294-2313.
- Siloto, R.M.P., Findlay, K., Lopez-Villalobos, A., Yeung, E.C. and Nykiforuk, C.L.** (2006) The accumulation of oleosins determines the size of seed oilbodies in *Arabidopsis*. *Plant Cell* **18**: 1961-1974.
- Sjodahl, S., Rodin, J., Rask, L.** (1991) Characterization of the 12S globulin complex of *Brassica napus*: Evolutionary relationship to other 11-12S storage globulins. *Eur. J. Biochem.* **196**: 617-621.
- Smith, M.A., Moon, H., Chowrira, G., Kunst, L.** (2003) Heterologous expression of a fatty acid hydroxylase gene in developing seeds of *Arabidopsis thaliana*. *Planta* **217**: 507-516.
- Somerville, C., Browse, J., Jaworski, J.G., Ohlrogge, J.B.** (2000) Lipids. In Buchanan, B., Gruissen, W. and Jones, R. (eds), *Biochemistry and molecular biology of plants*. American society of plant physiologists, Rockville, pp456-527.
- Song, W., Koh, S., Czako, M., Marton, L., Drenkard, E., Becker, J.M., Stacey, G.** (1997) Antisense expression of the peptide transport gene *AtPTR2-B* delays flowering and arrests seed development in transgenic *Arabidopsis* plants. *Plant Physiol.* **114**: 927-935.
- Stacey, M.G., Koh, S., Becker, J., Stacey, G.** (2002) AtOPT3, a member of the oligopeptide transporter family, is essential for embryo development in *Arabidopsis*. *Plant Cell* **14**: 2799-2811.
- Stacey, M.G., Patel, A., McCain, W.E., Mathieu, M., Remlay, M., Rogers, E.E., Gassmann, W., Blevins, D.G., Stacey, G.** (2007) The Arabidopsis AtOPT3 protein functions in metal homeostasis and movement of iron to developing seeds. *Plant Physiol.* Ahead of publication.
- Stadler, R., Lauterbach, C., Sauer, N.** (2005) Cell-to-cell movement of green fluorescent protein reveals post-phloem transport in the outer integument and identifies symplastic domains in *Arabidopsis* seeds and embryos. *Plant Physiol.* **139**: 701-712.
- Stahl, U., Carlsson, A.S., Lenman, M., Dahlqvist, A., Huang, B., Banas, W., Banas, A., Stymne, S.** (2004) Cloning and functional characterization of a phospholipids:diacylglycerol acyltransferase from *Arabidopsis*. *Plant Physiol.* **135**: 1324-1335.
- Stymne, S., Stobart, A.K.** (1987) Triacylglycerol biosynthesis. In Stumpf, P.K. and Conn, E.E. (eds), *The Biochemistry of Plants*, Vol. 9. Academic Press, New-York, pp175-214.
- Stone, S., Kwong, L., Yee, K., Pelletier, G., Lepiniec, L., Fischer, R., Goldberg, R., Harada, J.** (2001) *LEAFY COTYLEDON2* encodes a B3 domain transcription factor that induces embryo development. *Proc. Natl. Acad. Sci. USA* **98**: 11806-11811.
- Sun, J., Ke, J., Johnson, J.L., Nikolau, B.J., Wurtele, E.S.** (1997) Biochemical and molecular biological characterization of *CAC2*, the *Arabidopsis thaliana* gene coding for the biotin carboxylase subunit of the plastidic acetyl-coenzyme A carboxylase. *Plant Physiol.* **115**: 1371-1383.
- Tauchi-Sato, K., Ozeki, S., Houjou, T., Taguchi, R. and Fujimoto, T.** (2002) The surface of lipid droplets is a phospholipids monolayer with a unique fatty acid composition. *J. Biol. Chem.* **277**: 44507-44512.
- Taylor, D.C., Katavic, V., Zou, J.T., MacKenzie, S.L., Keller, W.A., An, J., Friesen, W., Barton, D.L., Pedersen, K.K., Giblin, E.M., Ge, Y., Dauk, M., Sonntag, C., Luciw, T., Males, D.** (2002) Field testing of transgenic rapeseed cv. Hero transformed with a yeast *sn-2* acyltransferase results in increased oil content, erucic acid content and seed yield. *Mol. Breed.* **8**: 317-322.
- Thelen, J.J., Ohlrogge, J.B.** (2002a) Both antisense and sense expression of biotin carboxyl carrier protein isoform 2 inactivates the plastid acetyl-coenzyme A carboxylase in *Arabidopsis thaliana*. *Plant J.* **32**: 419-431.
- Thelen, J.J., Ohlrogge, J.B.** (2002b) Metabolic engineering of fatty acid biosynthesis in plants. *Metab. Eng.* **4**: 12-21.
- To, A., Valon, C., Savino, G., Guillemot, J., Devic, M., Giraudat, J., Parcy, F.** (2006) A network of local and redundant gene regulation governs *Arabidopsis* seed maturation. *Plant Cell* **18**: 1642-1651.
- Tomlinson, K.L., McHugh, S., Labbe, H., Grainger, J.L., James, L.E., Pomeroy, K.M., Mullin, J.W., Miller, S.S., Dennis, D.T., Miki, B.L.A.** (2004) Evidence that the hexose-to-sucrose ratio does not control the switch to storage product accumulation in oilseeds: analysis of tobacco seed development and effects of overexpressing apoplast invertase. *J. Exp. Bot.* **55**: 2291-2303.
- Tzen, J.T. and Huang, A.H.C.** (1992) Surface structure and properties of plant seed oilbodies. *J. Cell Biol.* **117**: 327-335.
- Valentini, G., Chiarelli, L., Fortin, R., Speranza, M.L., Galizzi, A., Mattevi, A.** (2000) The allosteric regulation of pyruvate kinase. *J. Biol. Chem.* **275**: 18145-18152.
- Van der Klei, H., Van Damme, J., Casteels, P., Krebbers, E.** (1993) A fifth 2S albumin isoform is present in *Arabidopsis thaliana*. *Plant Physiol.* **101**: 1415-1416.
- Vicente-Carbajosa, J., Carbonero, P.** (2005) Seed maturation: developing an intrusive phase to accomplish a quiescent state. *Int. J. Dev. Biol.* **49**: 645-651.
- Vigeolas, H., van Dongen, J.T., Waldeck, P., Hühn, D., Geigenberger, P.** (2003) Lipid storage metabolism is limited by the prevailing low oxygen concentrations within developing seeds of oilseed rape. *Plant Physiol.* **133**: 2048-2060.
- Vigeolas, H., Geigenberger, P.** (2004a) Increased levels of glycerol-3-phosphate lead to a stimulation of flux into triacylglycerol synthesis after supplying glycerol to developing seeds of *Brassica napus* L. *β. Planta* **219**: 827-835.



- Vigeolas, H., Möhlmann, T., Martini, N., Neuhaus, H.E., Geigenberger, P.** (2004b) Embryo-specific reduction of ADP-Glc pyrophosphorylase leads to an inhibition of starch synthesis and a delay in oil accumulation in developing seeds of oilseed rape. *Plant Physiol.* **136**: 2676-2686.
- Vigeolas, H., Waldeck, P., Zank, T., Geigenberger, P.** (2007) Increasing seed oil content in oil-seed rape (*Brassica napus* L.) by over-expression of a yeast glycerol-3-phosphate dehydrogenase under the control of a seed-specific promoter. *Plant Biotech. J.* **5**: 431-441.
- Voelker, T.A., Worrell, A.C., Anderson, L., Bleibaum, J., Fan, C., Hawkins, D.J., Radke, S.E., Davies, H.M.** (1992) Fatty acid biosynthesis redirected to medium chains in transgenic oilseed plants. *Science* **257**: 72-74.
- Voelker, T.A., Hayes, T.R., Cranmer, A.M., Turner, J.C., Davies, H.M.** (1996) Genetic engineering of a quantitative trait: Metabolic and genetic parameters influencing the accumulation of laurate in rapeseed. *Plant J.* **9**: 229-241.
- Voelker, T.A., Kinney, A.J.** (2001) Variations in the biosynthesis of seed storage lipids. *Annu. Rev. Plant Physiol. Mol. Biol.* **52**: 335-261.
- Vogel, G., Browse, J.** (1996) Cholinephosphotransferase and diacylglycerol acyltransferase. *Plant Physiol.* **110**: 923-931.
- Von Wettstein-Knowles, P.M.** (1982) Elongase and epicuticular wax biosynthesis. *Physiol. Vég.* **20**: 797-809.
- Wakao, S., Benning, C.** (2005) Genome-wide analysis of glucose-6-phosphate dehydrogenases in Arabidopsis. *Plant J.* **41**: 243-256.
- Wang, H.-N., Zhang, B., Hao, Y.-J., Huang, J., Tian, A.-G., Liao, Y., Zhang, J.-S., Chen, S.Y.** (2007) The soybean Dof-type transcription factor genes, *GmDof4* and *GmDof11*, enhance lipid content on the seeds of transgenic plants. *Plant J.* **52**: 716-729.
- Weber, H., Borisjuk, L., Wobus, U.** (1997) Sugar import and metabolism during seed development. *Annu. Rev. Plant Physiol. Plant Mol. Biol.* **2**: 169-174.
- Weber, H., Borisjuk, L., Wobus, U.** (2005) Molecular physiology of legume seed development. *Annu. Rev. Plant Biol.* **56**: 253-279.
- Wei, Y.D., Periappuram, C., Datla, R., Selvaraj, G., Zou, J.T.** (2001) Molecular and physiological characterizations of a plastidic glycerol-3-phosphate dehydrogenase from Arabidopsis. *Plant Phys. Biochem.* **39**: 841-848.
- White, J.A., Todd, J., Newman, T., Focks, N., Girke, T., Martinez de Ilarduya, O., Jaworski, J.G., Ohlrogge, J.B., Benning, C.** (2000) A new set of Arabidopsis expressed sequence tags from developing seeds. The metabolic pathway from carbohydrate to seed oil. *Plant Physiol.* **124**: 1582-1594.
- Wise, M.J., Tunnacliffe, A.** (2004) POPP the question: what do LEA proteins do? *Trends Plant Sci.* **9**: 13-17.
- Wobus, U., Weber, H.** (1999) Seed maturation: genetic programmes and control signals. *Curr. Opin. Plant Biol.* **2**: 33-38.
- Wu, G., Truksa, M., Datla, N., Vrinten, P., Bauer, J., Zank, T., Cirpus, P., Heinz, E., Qiu, X.** (2005) Stepwise engineering to produce high yields of very long-chain polyunsaturated fatty acids in plants. *Nat. Biotechnol.* **23**: 1013-1017.
- Wu, G., Wu, Y., Xiao, L., Li, X., Lu, C.** (2007) Zero erucic acid trait of rapeseed (*Brassica napus* L.) results from a deletion of four base pairs in the *fatty acid elongase 1* gene. *Theor. Appl. Genet.* Ahead of publication.
- Yadav, N.S., Wiersbicki, A., Aegerter, M., Caster, C.S., Pérez-Grau, L., Kinney, A.J., Hitz, W.D., Booth, J.R.B., Jr., Schweiger, B., Stecca, K.L., Allen, S.M., Blackwell, M., Relter, R.S., Carlson, T.J., Russell, S.H., Feldmann, K.A., Pierce, J., Browse, J.** (1993) Cloning of higher plant  $\omega$ -3 fatty acid desaturases. *Plant Physiol.* **103**: 467-478.
- Yanai, Y., Kawasaki, T., Shimada, H., Wurtele, E.S., Nikolau, B.J., Ichikawa, N.** (1995) Genomic organization of 251 kDa acetyl-CoA carboxylase genes in *Arabidopsis*: tandem gene duplication has made two differentially expressed isoenzymes. *Plant Cell Physiol.* **36**: 779-787.
- Yatsu, L.Y., Jacks, T.J.** (1972) Spherosome membranes: half unit-membranes. *Plant Physiol.* **49**: 937-943.
- Yeung, E.C., Meinke, D.W.** (1993) Embryogenesis in Angiosperms: development of the suspensor. *Plant Cell* **5**: 1371-1381.
- Zhang, W.-H., Zhou, Y., Dibley, K.E., Tyerman, S.D., Furbank, R.T., Patrick, J.W.** (2007) Nutrient loading of developing seeds. *Funct. Plant Biol.* **34**: 314-331.
- Zheng, H., Rowland, O., Kunst, L.** (2005) Disruptions of the Arabidopsis enoyl-CoA reductase gene reveal an essential role for very-long-chain fatty acid synthesis in cell expansion during plant morphogenesis. *Plant Cell* **17**: 1467-1481.
- Zou, J., Katavic, V., Giblin, E.M., Barton, D.L., MacKenzie, S.L., Keller, W.A., Hu, X., Taylor, D.C.** (1997) Modification of seed oil content and acyl composition in the Brassicaceae by expression of a yeast *sn-2* acyltransferase gene. *Plant Cell* **9**: 909-923.
- Zou, J., Wei, Y., Jako, C., Kurnar, A., Selvaraj, G., Taylor, D.C.** (1999) The *Arabidopsis thaliana* TAG1 mutant has a mutation in a diacylglycerol acyltransferase gene. *Plant J.* **19**: 645-653.