



Population Genetics of *Oligonychus perseae* (Acari: Tetranychidae) Collected from Avocados in Mexico and California

Authors: Lara, Jesús R., Rugman-Jones, Paul F., Stouthamer, Richard, and Hoddle, Mark S.

Source: Florida Entomologist, 100(3) : 616-626

Published By: Florida Entomological Society

URL: <https://doi.org/10.1653/024.100.0320>

BioOne Complete (complete.BioOne.org) is a full-text database of 200 subscribed and open-access titles in the biological, ecological, and environmental sciences published by nonprofit societies, associations, museums, institutions, and presses.

Your use of this PDF, the BioOne Complete website, and all posted and associated content indicates your acceptance of BioOne's Terms of Use, available at www.bioone.org/terms-of-use.

Usage of BioOne Complete content is strictly limited to personal, educational, and non - commercial use. Commercial inquiries or rights and permissions requests should be directed to the individual publisher as copyright holder.

BioOne sees sustainable scholarly publishing as an inherently collaborative enterprise connecting authors, nonprofit publishers, academic institutions, research libraries, and research funders in the common goal of maximizing access to critical research.

Population genetics of *Oligonychus perseae* (Acari: Tetranychidae) collected from avocados in Mexico and California

Jesús R. Lara^{1,*}, Paul F. Rugman-Jones¹, Richard Stouthamer¹, and Mark S. Hoddle¹

Abstract

Oligonychus perseae Tuttle, Baker & Abbatiello (Acari: Tetranychidae) is an economically important foliar pest of avocados from Mexico. Invasive *O. perseae* populations became established throughout the commercial avocado system in California (USA) during the early 1990s, but the putative geographic origin(s) of the California *O. perseae* populations has not been investigated. To address this shortcoming, a series of population genetic analyses for *O. perseae* populations representative of a broad geographic sample range was conducted. This study identified a single mitochondrial cytochrome c oxidase subunit I (COI) haplotype match between *O. perseae* populations collected in California with those from 4 municipalities in Michoacán, Mexico, part of the presumptive native range of this pest. Interestingly, this haplotype also was collected from avocados at 2 locations in Baja California, Mexico, and it was identified from a representative sample from Israel where *O. perseae* is an invasive avocado pest. Molecular data confirm the likely Mexican origin of invasive *O. perseae* populations in California, and may help delimit the geographic area to be searched for coevolved natural enemies of *O. perseae* that could be introduced into California as part of a future classical biological control program targeting this pest. Moreover, molecular results uncovered significant and concordant genetic divergence in both mitochondrial (COI) and ribosomal DNA markers, i.e., internal transcribed spacer 2 (ITS2) and a section of the 28S gene region, pointing to the potential occurrence of a cryptic species complex within *O. perseae*. The implications of these findings on future taxonomic and molecular work for *O. perseae* are discussed.

Key Words: perseae mite; invasive species; native origin; cryptic species

Resumen

Oligonychus perseae Tuttle, Baker & Abbatiello (Acari: Tetranychidae) es una plaga foliar proveniente de México con suma importancia económica para el cultivo de aguacate. Poblaciones invasoras de *O. perseae* se establecieron en el sistema de producción comercial de aguacate en California (E.U.A.) a principios de la década de 1990. Sin embargo, el supuesto origen geográfico de las poblaciones de *O. perseae* en California no ha sido investigado. Para abordar esta limitación, se realizó una serie de análisis genéticos utilizando poblaciones de *O. perseae* que representan un amplio rango geográfico de muestras. En el presente estudio se encontró que las poblaciones de *O. perseae* en California comparten el mismo haplotipo singular con 4 municipios en el estado de Michoacán, México, parte del presunto rango nativo de esta plaga. A la vez, este haplotipo también se asoció con 2 sitios localizados en el estado de Baja California, México, y también fue identificado de una muestra de Israel, en donde *O. perseae* es una plaga invasora que ataca al cultivo de aguacate. Resultados de los análisis moleculares confirmaron el probable origen Mexicano de las poblaciones invasoras de *O. perseae* en California. Esta información ayuda a reducir la zona geográfica de búsqueda en México para encontrar enemigos naturales que coevolucionaron con *O. perseae* con el fin de desarrollar un programa de control biológico clásico para esta plaga en el sistema de aguacate en California. Más aún, los análisis moleculares revelaron divergencia genética significativa y concordante en el ADN mitocondrial citocromo c oxidasa subunidad I (COI) y ribosomal, espacio interno transcrito 2 (ITS2) y parte de la región del gene 28S. Esto señala la posible ocurrencia de un complejo críptico de especies dentro de *O. perseae*. Las implicaciones de estos hallazgos con respecto a futuro trabajo taxonómico y molecular para *O. perseae* son abarcadas.

Palabras Clave: ácaro cristalino del aguacate; especie invasora; origen nativo; especie críptica

The perseae mite, *Oligonychus perseae* Tuttle, Baker & Abbatiello (Acari: Tetranychidae), is a foliar pest of avocados, *Persea americana* Miller (Lauraceae). Both pest and host are native to Mexico, which historically has been the world's largest commercial producer of avocado fruit (Tuttle et al. 1976; Chen et al. 2009; USDA–FAS 2015). Foliar feeding by *O. perseae* populations induces premature defoliation, which in turn increases the risk of sunburnt fruit and reduced fruit yield (Aponte & McMurtry 1997; Maoz et al. 2011). Crop damage resulting from *O. perseae* infestations is also a concern in other avocado growing coun-

tries where adventive populations of this spider mite have successfully established, including Costa Rica (1978), the United States (California) (1990), Israel (2001), Spain (2004), Portugal (2005), and Italy (2014) (Lara & Hoddle 2015a; Zappalà et al. 2015).

In California, *O. perseae* was first recorded in 1990 on residential avocado trees in San Diego County. Thereafter, *O. perseae* spread rapidly throughout commercial avocado growing areas, covering an area extending more than 400 km from San Diego County to San Luis Obispo County (Bender 1993). *Oligonychus perseae* is 1 of several

¹University of California, Department of Entomology, Riverside, California 92521, USA; E-mail: jesus.lara@ucr.edu (J. R. L.), paul.rugman-jones@ucr.edu (P. F. R.-J.), richard.stouthamer@ucr.edu (R. S.), mark.hoddle@ucr.edu (M. S. H.)

*Corresponding author; E-mail: jesus.lara@ucr.edu (J. R. L.)

exotic species that have successively established in the California avocado system since the 1980s. This complex of exotics includes the red banded whitefly, *Tetraleurodes perseae* Nakahara (Hemiptera: Aleyrodidae) (detected in 1982), avocado thrips, *Scirtothrips perseae* Nakahara (Thysanoptera: Thripidae) (detected in 1996), the avocado lace bug, *Pseudacysta perseae* (Heidemann) (Hemiptera: Tingidae) (detected in 2004), and the thrips *Neohydatothrips burungae* (Hood) (Thysanoptera: Thripidae) (detected in 2004) (Hoddle 2005). All of these species require avocado foliage on which to feed to complete their life cycle, but *O. perseae* is the primary foliar pest of avocados in California, and tends to be most problematic over the spring and summer months.

California produces 90% of all fresh avocados in the USA with an annual value exceeding \$300 million (US), and more than 90% of avocados produced in California are cultivar 'Hass' (CAC 2015). This high market-value cultivar, which was developed in California, has proven to be highly susceptible to foliar feeding injury from *O. perseae* (Kerguelen & Hoddle 2000). The severity of *O. perseae* infestations in California can readily exceed the recommended action threshold of 50 to 100 mites per leaf (Maoz et al. 2011; Lara & Hoddle 2015b). Thus, effective sampling and control options are needed to prevent *O. perseae* damage during the growing season. Although pesticide applications are cost-effective, pesticide resistance has been detected among *O. perseae* populations sampled from California (Humeres & Morse 2005). To mitigate resistance development, new pesticide chemistries have been registered, and complementary sampling plans have been developed to promote judicious pesticide use in commercial avocado orchards (Hoddle & Morse 2012; Lara & Hoddle 2015b). Nevertheless, heavy reliance on chemical control remains an unsustainable management strategy for *O. perseae*.

As an alternative, augmentative biological control through releases of a commercially-available phytoseiid mite, *Neoseiulus californicus* (McGregor), have been shown to reduce *O. perseae* populations to non-economic levels when deployed at a rate of 2,000 predators per tree (Hoddle et al. 2000). Unfortunately, releases of *N. californicus* are required annually to ensure *O. perseae* control and the associated expense renders this approach impractical for management of this pest in commercial orchards. Additionally, native phytoseiids, *Euseius* species, may also feed on *O. perseae* in commercial orchards, but their primary feeding ecology as pollen specialists limits their peak abundance to spring months when avocado trees are blooming (McMurtry & Johnson 1966; McMurtry et al. 2013). *Oligonychus perseae* densities are typically low during the spring, and consequently, this temporal asynchrony of *Euseius* species with *O. perseae* phenology results in these predators being unable to provide reliable control of *O. perseae* populations during summer when outbreaks of this pest are likely to occur (Yee et al. 2001).

The limited efficacy of currently-available biological control options has generated interest in foreign exploration efforts to search for potentially effective natural enemies of *O. perseae* from its native range in Mexico for possible introduction into the California avocado system. Classical biological control attempts to re-associate host-specific co-evolved natural enemies from the native range of a target pest with the invasive population in the introduced range (Hoddle 2016). Thus, determining the geographic origin of invasive *O. perseae* populations in California is a fundamental step in the development of a classical biological control program targeting *O. perseae* in California. Population genetics can provide insight into the probable geographic areas of origin for invasive pests (Rugman-Jones et al. 2007, 2012) but limited molecular work has been conducted on *O. perseae* populations in Mexico with samples from the Mexican states of México and Michoacán only (Guzmán-Valencia et al. 2014). A broader geographic sample is

required before meaningful inferences about the origin of Californian populations can be drawn. Here, we present results from the first attempt to characterize genetic variation among native *O. perseae* populations across Mexico (with a focus on important avocado growing regions) and exotic populations in California, Israel, and Spain.

Materials and Methods

SPECIMEN COLLECTION

Adult *O. perseae* were collected by JRL and MSH from infested avocado foliage in California (USA), 6 states in Mexico, and cultivar 'Hass' production areas in Costa Rica (Fig. 1). *Oligonychus perseae* specimens from Spain were collected by E. Hernandez-Suarez (Canarian Institute of Agrarian Research, Tenerife, Spain) and M. Montserrat (Institute for Mediterranean and Subtropical Horticulture, Málaga, Spain) (Table 1). In Mexico, sampling was primarily conducted in the state of Michoacán because it is the primary commercial producer of cultivar 'Hass' avocados in Mexico (Sánchez-Colín et al. 2001; USDA-FAS 2015), and prior to 27 Jun 2016, was the only Mexican state that could legally export avocado fruit to the USA (Boriss et al. 2006; USDA-APHIS 2016), thus making Michoacán a recognized potential source of *O. perseae* populations in southern California. Specimens were collected from multiple leaves on individual trees directly into labeled vials containing 95% ethanol, and subsequently stored at -20°C . Identity of the specimens was initially assessed using morphological and behavioral diagnostic characteristics of *O. perseae* (Ochoa et al. 1994; Aponte & McMurtry 1997), and subsequently confirmed by sequencing the internal transcribed spacer 2 of (*ITS2*) ribosomal RNA (see below), and matching the sequence with deposited sequences of *O. perseae* from Mexico (accessions KC568365-KC568386), Spain (accession GU565305), and Israel (accessions DQ656456-DQ656458), through BLAST searches using GenBank.

DNA EXTRACTION AND AMPLIFICATION

Whole genomic DNA was extracted from individual female specimens using the EDNA HiSpEx tissue kit (Saturn Biotech, Perth, Australia), following the manufacturer protocol for extraction from 1 mm³ of tissue, but reducing the reagent volumes by 75% (total extraction volume 25 μL). The mitochondrial (mtDNA) cytochrome c oxidase subunit I (*COI*) and ribosomal (rRNA) internal transcribed spacer 2 (*ITS2*) region were amplified using the primer pairs, 5'-ATATGCTTAAATTCAGC-GGG-3' and 5'-GGGTCGATGAAGAACGCAGC-3'; and, 5'-TGATTTTTTG-GTACCAGAAG-3' and 5'-TACAGCTCCTATAGATAAAAC-3', respectively (Navajas et al. 1998). PCR was performed in 25 μL reactions containing 2 μL of DNA template (concentration not determined), 1 \times ThermoPol PCR buffer (New England Biolabs, Ipswich, Massachusetts), 200 μM each dNTP, 1 μL of bovine serum albumin (BSA) (New England Biolabs, Ipswich, Massachusetts), 0.2 μM of each primer, 2 mM MgCl₂ and either 1 (*ITS2*) or 2 (*COI*) units of *Taq* polymerase (New England Biolabs, Ipswich, Massachusetts). Amplification was performed in a Mastercycler 5331 (Eppendorf, Hamburg, Germany) programmed for: an initial denaturing step of 4 min at 95 $^{\circ}\text{C}$, followed by 35 cycles of 1 min at 92 $^{\circ}\text{C}$, 1 min at 45 $^{\circ}\text{C}$, 1.5 min at 72 $^{\circ}\text{C}$; and a final extension of 3 min at 72 $^{\circ}\text{C}$.

Based on unforeseen but corroborating levels of variation in *COI* and *ITS2* sequences (see Results), a second, more conserved region of rRNA, 28S, also was amplified for representatives of each mitochondrial haplotype, using the 28sF3633 and 28sR4076 primers and protocol detailed in Rugman-Jones et al. (2010).

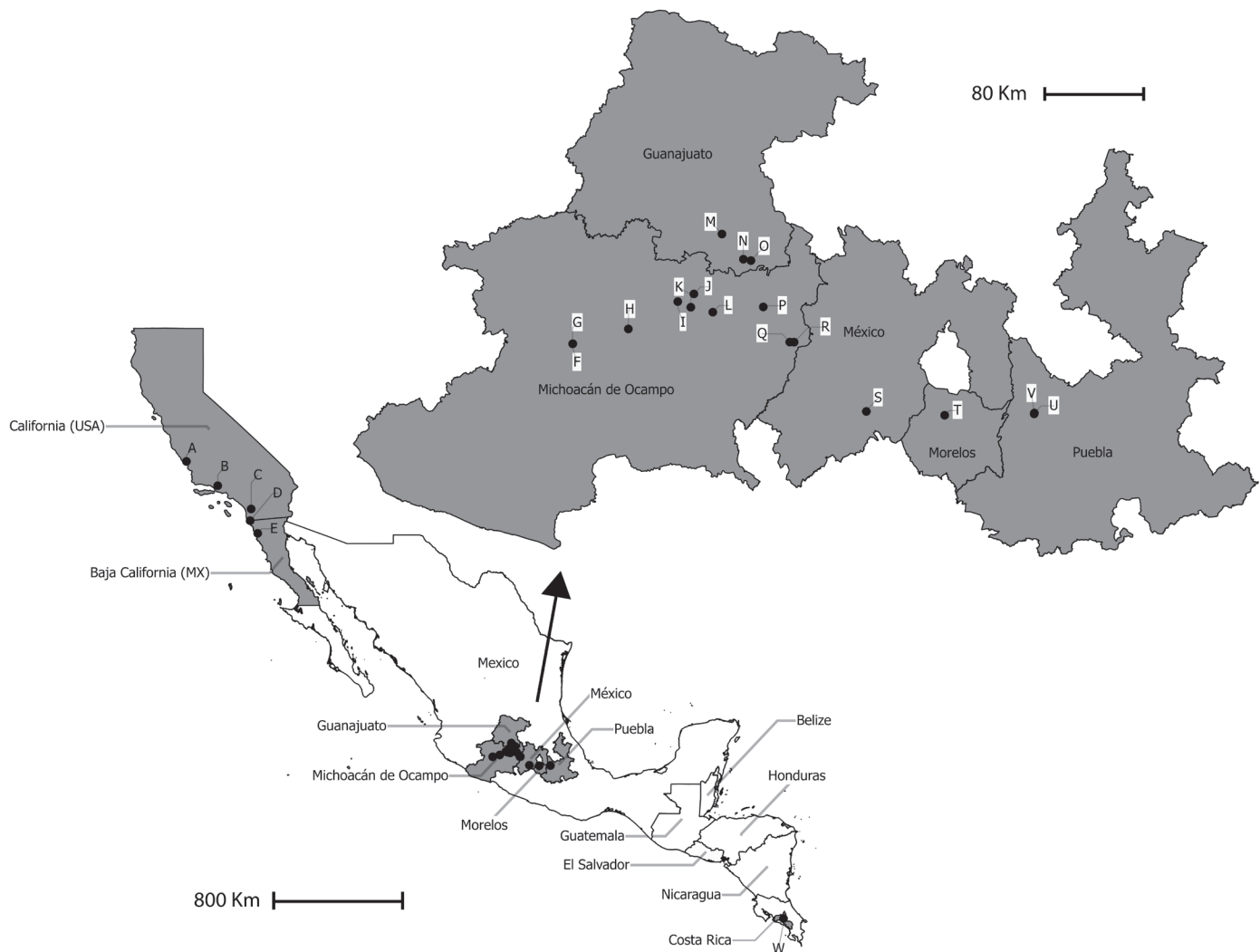

Fig. 1. Map showing *Oligonychus perseae* collection sites (filled circles) from California (USA), Mexico, and Costa Rica (gray areas). See Table 1 for further site details.

AMPLIFIED DNA CLEANING AND SEQUENCING

Successful amplification of each marker was confirmed by visualizing PCR products after electrophoresis on 1% agarose gels stained with ethidium bromide. PCR products were purified using the Wizard[®] PCR Preps DNA Purification System (Promega, Madison, Wisconsin) and sequenced in both directions at the Institute for Integrative Genome Biology, University of California (Riverside, California). Forward and reverse sequence reads were aligned manually using BioEdit version 7.1.11 (Hall 1999).

GENETIC ANALYSES

COI sequences were collapsed into haplotypes, and the number and nature of polymorphic sites were characterized using DnaSp v. 5.10.01 (Librado & Rozas 2009). The haplotypes generated in our study were then combined with a further 29 congeneric haplotypes, and those of 4 outgroup taxa (Acari: Tetranychidae), *Tetranychus pueraricola* Ehara & Gotoh, *Tetranychus kanzawai* Kishida, *Tetranychus truncatus* Ehara, and *Eotetranychus celtis* Ehara, retrieved from GenBank (see Fig. 2 for accession numbers). Sequences were aligned using MUSCLE (Edgar 2004), and then trimmed to 305 base pairs using Gblocks (Castresana 2000) to remove overhanging sequence tails, before genealogical rela-

tionships among the haplotypes were estimated using maximum likelihood (ML) analyses conducted with PhyML (v3.0 aLRT) (Guindon et al. 2010); all via the online Phylogeny.fr platform (Dereeper et al. 2008). The HKY85 substitution model was selected assuming an estimated proportion of invariant sites (of 0.376) and 4 gamma-distributed rate categories to account for rate of heterogeneity across sites. The gamma shape parameter was estimated directly from the data (gamma = 0.431). Branch support was assessed using the approximate likelihood-ratio test (SH-Like). ML analyses revealed the existence of 3 divergent clades (see Results), and so, divergence within and between these clades was estimated as average Kimura 2-parameter (K2P) distances calculated using MEGA version 6.06 (Tamura et al. 2013).

Sequences of the *ITS2* rRNA region were aligned with MAFFT version 7 using the Q-INS-i strategy (Katoh & Standley 2013) and manually collapsed into genotypes. These genotypes were combined with additional *ITS2* sequences retrieved from GenBank, encompassing *O. perseae* samples from Mexico (Guzmán-Valencia et al. 2014; accessions KC568365–KC568386), Israel (DQ656457–DQ656458), and Spain (GU565305), and realigned. Five sequences, KC568367 and KC568378–381, from Guzmán-Valencia et al. (2014) were subsequently discarded because they were particularly short, or because their inclusion induced multiple single gaps at the 5' end of the alignment matrix, a

Table 1. Collection information for representative *Oligonychus perseae* populations studied (see Fig. 1).

Site	Locality (site, county, state, country)	Latitude	Longitude	Sample date	COI		Accession number	
					haplotype	COI	ITS2	28S
A	Cambria, San Luis Obispo, California, USA	35.579041	-121.03588	Aug 2011	H8	KY474146-148	KY474271-273	KY474115-116
B	Santa Paula, Ventura, California, USA	34.344475	-119.09321	Jun 2011	H8	KY474149-152	KY474275-278	NT
C	Escondido, San Diego, California, USA	33.14547	-117.02165	Jul 2012	H8	KY474153-156	KY474274, KY474279-281	NT
D	Soler, Tijuana, Baja California, Mexico	32.53635	-117.08163	Jan 2011	H8	KY474157-158	KY474238-241	NT
E	Ensenada, Baja California, Mexico	31.871817	-116.614633	Jul 2011	H8	KY474159-161	KY474210-213	NT
F	Colorín Norte, Uruapan, Michoacán, Mexico	19.421867	-102.03926	May 2012	H8	KY474165-168	KY474224-227	NT
G	El Colorín, Uruapan, Michoacán, Mexico	19.421148	-102.04083	May 2012	H8	KY474162-164	KY474221-223	NT
H	Los Nogales, Pátzcuaro, Michoacán, Mexico	19.529761	-101.6088	May 2012	H1	KY474132-134	KY474288-290	KY474124-125
I	Fraccionamiento la Aurora, Morelia, Michoacán, Mexico	19.729377	-101.22553	May 2012	H8	KY474173-176	KY474250-253	NT
J	Cuitzillo, Tarímbaro, Michoacán, Mexico	19.785389	-101.10055	May 2012	H7, H8	KY474145, KY474177-179	KY474218-220, KY474244	KY474117
K	Puerto de Buenavista, Charo, Michoacán, Mexico	19.68821	-101.12464	May 2012	H8	KY474169-172	KY474245-248	NT
L	El Temazcal, Charo, Michoacán, Mexico	19.652198	-100.95429	May 2012	H2, H3	KY474135-137	KY474234, KY474291-296	KY474126-128
M	Flores Magón, Salvatierra, Guanajuato, Mexico	20.22157	-100.88312	May 2012	H9	KY474184	KY474235-236, KY474259-260	NT
N	Zona Centro, Acámbaro, Guanajuato, Mexico	20.038183	-100.71726	May 2012	H11	KY474196-198	KY474233, KY474256-258	KY474121
O	San Francisco de la Piedad, Acámbaro, Guanajuato, Mexico	20.028304	-100.65868	May 2012	H10	KY474190-193	KY474237, KY474266-268	KY474122, KY474123
P	Bellavista, Ciudad Hidalgo, Michoacán, Mexico	19.690428	-100.56294	May 2012	H6	KY474141-144	KY474214-216, KY474249	KY474118-119
Q	Mejchor Ocampo, Zitácuaro, Michoacán, Mexico	19.43387	-100.35732	May 2012	H9	KY474185-189	KY474261-265	NT
R	Las Lomas, Zitácuaro, Michoacán, Mexico	19.433412	-100.32396	May 2012	H9	KY474180-183	KY474228, KY474254, KY474255, KY474287	KY474120
S	Coatepec Harinas, Coatepec Harinas, México, Mexico	18.926629	-99.763923	May 2012	H11	KY474202-203	KY474229-232	NT
T	San Lucas, Jiutepec, Morelos, Mexico	18.898446	-99.156975	May 2012	H11	KY474204-206	KY474217, KY474242-243	NT
U	Santa Cruz Axocopan, Atlixco, Puebla, Mexico	18.914855	-98.461292	May 2012	H11	KY474199-201	KY474282-284	NT
V	La Magdalena Axocopan, Atlixco, Puebla, Mexico	18.908385	-98.463107	May 2012	H10	KY474194-195	KY474285-286	NT
W	San Martín, León Cortés, San José, Costa Rica	9.732419	-84.00945	Jun 2010	H4, H5	KY474138-140	KY474297-299	KY474129-131
X	La Mayora, Algarrobo, Málaga, Spain	36.757963	-4.043559	Jun 2010	NT	NT	KY474269-270	NT

COI = cytochrome c oxidase subunit 1, ITS2 = internal transcribed spacer 2, NT = not tested.

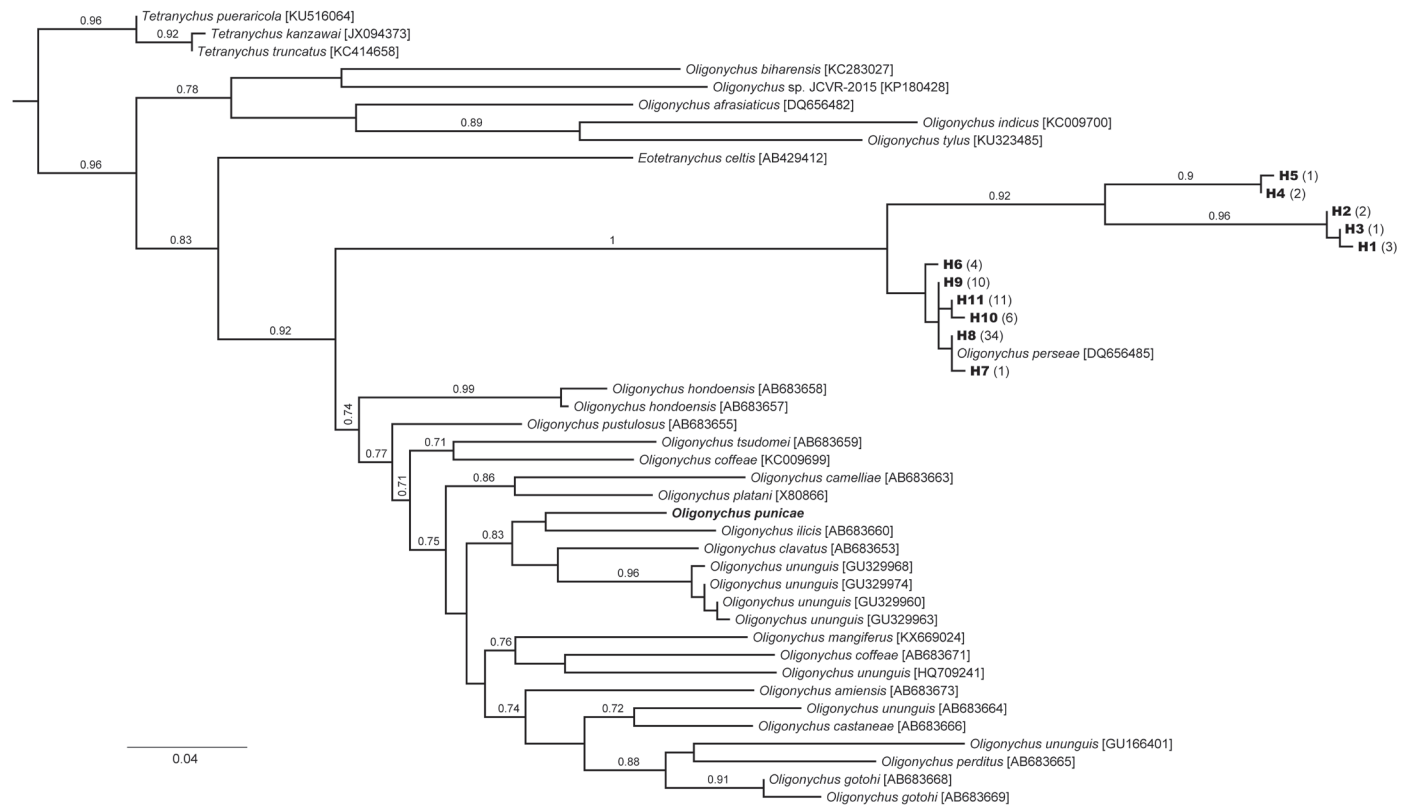

Fig. 2. Genealogical relationships among 11 cytochrome oxidase subunit 1 (*COI*) haplotypes detected in *Oligonychus perseeae* populations in California, Mexico, and Costa Rica. Additional congeneric and outgroup sequences were retrieved from GenBank. Maximum likelihood tree constructed from a 305 base pair section of *COI* using PhyML. Support (aLRT) for major branches is shown.

trait typical of low quality reads. The sequences were aligned for a third time and non-overlapping regions were removed, resulting in an alignment incorporating 25 sequences in a 366-base-pair matrix (including gaps). Relationships among the *ITS2* genotypes were investigated using MEGA version 6.06, by constructing a neighbor joining (NJ) tree based on pairwise uncorrected p-distance. Gapped positions were removed for each sequence pair, and branch support was assessed by bootstrapping with 1,000 replicates.

Seventeen representative sequences of 28S rRNA also were aligned separately using the Q-INS-i strategy in MAFFT version 7 and manually collapsed into genotypes. The resulting 28S alignment contained no gaps and was 641 base pairs long. Relationships among the 28S genotypes were investigated again by constructing a NJ tree based on pairwise uncorrected p-distance using MEGA version 6.06.

Results

Among *COI* sequences collected from 75 individuals, 35 polymorphic nucleotide sites were identified comprising a total of 11 haplotypes, H1 to H11 (Table 1). California specimens were fixed for a single *COI* haplotype (H8). The same haplotype also was recovered from specimens collected in: 2 municipalities (counties), Tijuana and Ensenada (Table 1, sites D and E), in the Mexican state of Baja California; 4 municipalities, Uruapan, Charo, Morelia, and Tarímbaro (Table 1, sites F, G, I, J, and K), in the Mexican state of Michoacán; and, also was previously recorded from an Israeli specimen (DQ656485). Surprisingly, the ML analysis provided strong evidence of 3 divergent *COI* haplotype clusters (branch support > 0.9; Fig. 2). Cluster 1 included haplotypes H6 to H11 and represented samples from California (USA) (Table 1, sites A, B, and

C), Mexico (Table 1, sites D–G, I–K, and M–V), and Israel (accession DQ656485). Cluster 2 included haplotypes H1 to H3, corresponding to samples only from Mexico (Table 1, sites H and L). Cluster 3 included haplotypes H4 and H5, corresponding to samples from Costa Rica (Table 1, site W). Variation within each cluster ranged from 0.2 to 0.4 % (mean pairwise K2P distance \pm SE (standard error); cluster 1 = 0.004 ± 0.002 , cluster 2 = 0.004 ± 0.003 , and cluster 3 = 0.002 ± 0.002). Divergence between clusters was around 20-fold higher (mean pairwise K2P distance; between clusters 1 and 2 = 0.083 ± 0.016 , between 1 and 3 = 0.079 ± 0.016 , and between 2 and 3 = 0.073 ± 0.016).

Four genotypes were identified in the *ITS2* sequences (Fig. 3; Table 1). These genotypes grouped our specimens into the same 3 genetic clusters as the *COI* data (Fig. 4). All Californian specimens ($n = 11$) shared a single *ITS2* genotype (G1) containing 2 heterozygous nucleotides at positions 284 and 317; in both cases A to T transversions (Fig. 3). This genotype also was present in the majority of our specimens from Mexico ($n = 61$). Heterozygosity was absent at those 2 positions (A and T, respectively) in a second, less abundant genotype (G2) that was otherwise identical (Fig. 3). This homozygous genotype was detected in all 5 specimens collected from Atlixco, Puebla, Mexico (Table 1) and a single specimen from Zitácuaro, Michoacán, Mexico (KY474287). All specimens with a *COI* cluster 1 haplotype (H6–H11), had one of these 2 *ITS2* genotypes. All of our Mexican specimens with a *COI* cluster 2 haplotype (H1–H3), shared a single *ITS2* genotype (G3) that differed from that of cluster 1 at multiple positions (Fig. 3). Finally, Costa Rican samples (*COI* cluster 3, haplotypes H4 and H5) shared a further *ITS2* genotype (G4), that contained a heterozygous nucleotide at position 224 (a C to T transition), and that also differed from the others at multiple positions (Fig. 3). Combination of our 4 *ITS2* genotypes with existing *O. perseeae* sequences retrieved from GenBank revealed the follow-

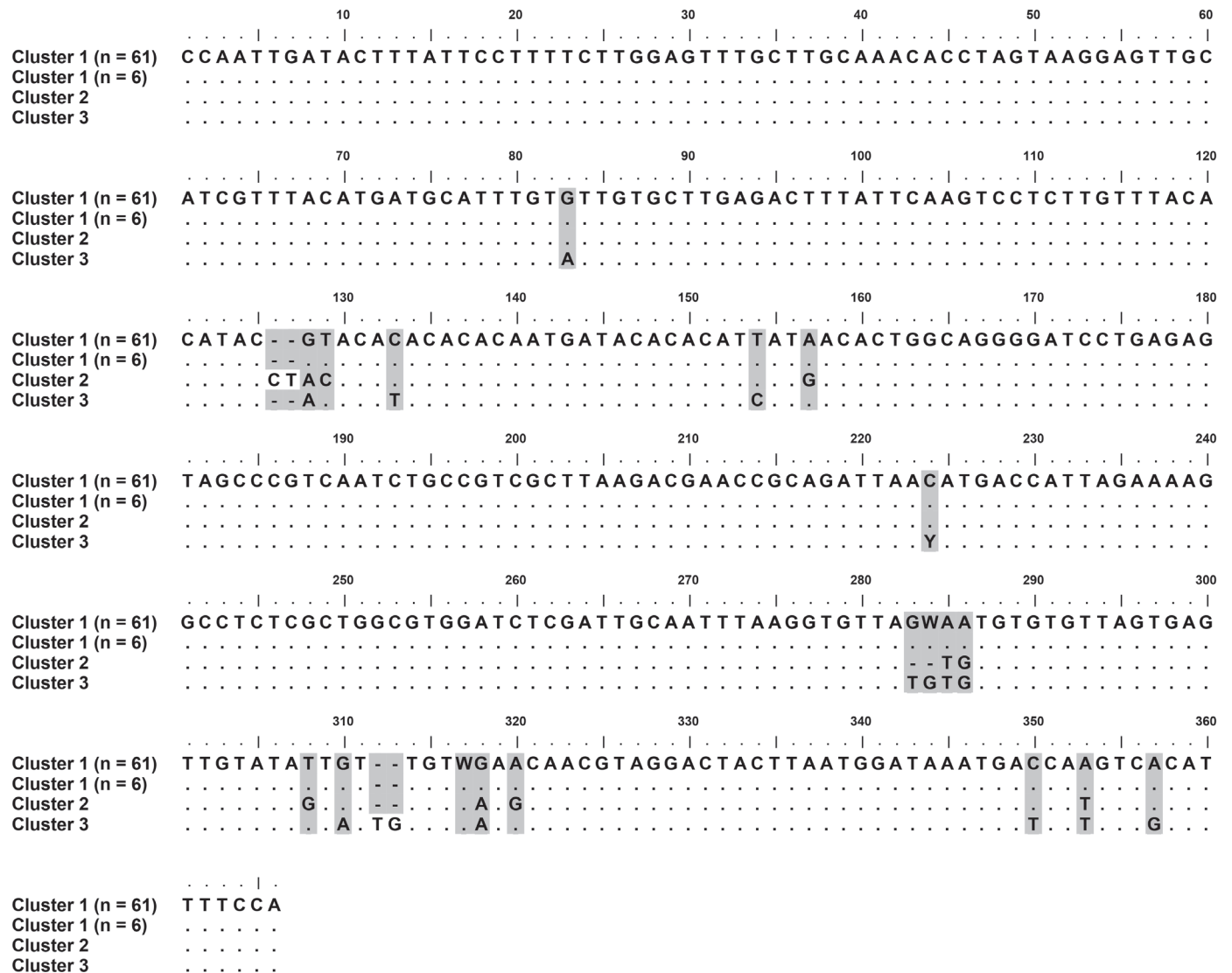

Fig. 3. Sequence variation among 4 internal transcribed spacer 2 (*ITS2*) genotypes identified from *Oligonychus perseae* populations in California, Mexico, and Costa Rica. Genotypes are named according to 3 genetic clusters identified from cytochrome oxidase subunit 1 (*COI*) haplotypes (see Fig. 2).

ing patterns: *ITS2* sequences from Israel (DQ656456–458; Ben-David et al. 2007) and Spain (GU565305; Perez-Sayas et al., unpublished) grouped with *COI* cluster 1, along with 4 sequences from Mexico (KC568382–385; Guzmán-Valencia et al. 2014) (Fig. 4). With the exception of KC568382 and KC568385, all variation within this cluster was restricted to the heterozygous positions 284 and 317. The remaining 14 Mexican sequences that were included from Guzmán-Valencia et al. (2014) grouped with cluster 2 (Fig. 4). Nine were an exact match for our cluster 2 *ITS2* genotype, and 3 sequences (KC568366, KC568368, and KC568374) differed by only a single nucleotide substitution, each at a different position. The remaining genotype represented by KC568377 differed at multiple positions.

Finally, the more conserved 28S rRNA sequences representative of the 11 *COI* haplotypes detected in this study, also contained 4 genotypes (Fig. 5; Table 1) and recovered the same genetic clustering pattern as both *COI* and *ITS2* (Fig. 6). Within *COI* cluster 1, all specimens had one of two 28S haplotypes, which differed from each other by only a single nucleotide substitution at position 579 (e.g., KY474115 and KY474121). All specimens with a *COI* haplotype from cluster 2 shared a 28S haplotype that differed from those of cluster 1 at 11 nucleotide

positions (Fig. 5). Similarly, specimens with a *COI* haplotype from cluster 3 shared a 28S haplotype that differed from those of cluster 1 at 10 nucleotide positions (Fig. 5). Cluster 2 and 3 haplotypes differed from each other at 3 nucleotide positions (Fig. 5).

Discussion

The primary goal of this study was to circumscribe the potential geographic origin of *O. perseae* populations in California from within the assumed native range of this pest in Mexico. Clarification of the origin of exotic *O. perseae* populations found in California would help document its invasion history as has been done for other exotic avocado pests established in California that originated from Mexico (Rugman-Jones et al. 2007, 2012), and also guide the development of future classical biological control programs for *O. perseae* in the California avocado system.

DNA extraction and amplification of *COI*, 28S and *ITS2* genes from single adult *O. perseae* were successful. All *ITS2* sequences from California clustered with *O. perseae* *ITS2* sequence data (Fig. 4) represen-

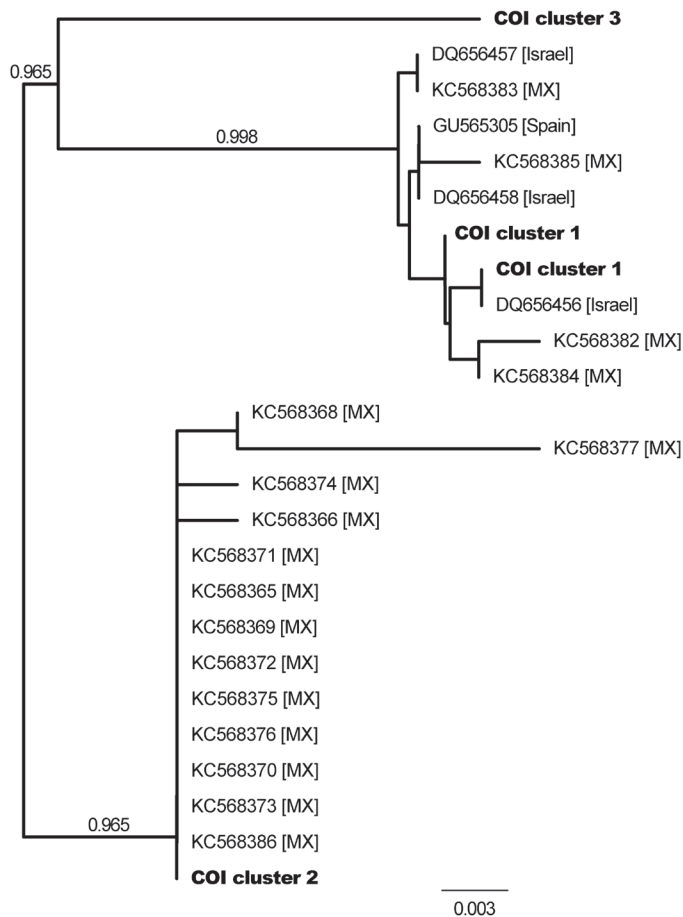

Fig. 4. Divergence in the internal transcribed spacer 2 (*ITS2*) rRNA region among *Oligonychus perseae* specimens with deeply diverged mitochondrial haplotypes (see Fig. 2). Additional sequences from Ben-David et al. (2007), Guzmán-Valencia et al. (2014), and Perez-Sayas et al. (unpublished). Neighbor-joining tree constructed in MEGA version 6.06. Tree is drawn to scale and branch lengths represent number of base differences per site (p-distance). Bootstrap (1,000 replicates) support shown for major branches.

tative of Israel, Spain and various regions in Mexico (Ben-David et al. 2007; Guzmán-Valencia et al. 2014). Examination of *COI* haplotypes revealed that one, H8, is fixed in California. Haplotype H8 has also been recorded in an invasive population in Israel (DQ656485). Within Mexico, we recovered H8 from 2 locations in Baja California, and 3 locations in Michoacán, but not from states neighboring Michoacán (i.e., Puebla, Guanajuato, México, and Morelos). Like California (USA), Baja California (Mexico) is not part of the native home range of avocado (Bost et al. 2013), and so, *O. perseae* is likely also invasive there, thus implicating the state of Michoacán as the probable source of *O. perseae* populations found in California, as well as in Baja California and Israel. Given that 37% of our samples from Mexico (i.e., 23 out of 61 Mexican specimens) shared the H8 haplotype, it is possible that there may have been multiple introductions of *O. perseae* from Mexico into other avocado growing regions. However, it is also plausible that invasive populations may have subsequently acted as invasion bridgeheads from which infestations spread. However, we cannot unambiguously discern this based on our data. For now, the present detection of a fixed *COI* haplotype, H8, from *O. perseae* populations in California (i.e., San Luis Obispo, Ventura, and San Diego counties) indicates that there has been at least one successful introduction event of *O. perseae* into California,

and the ultimate phylogeographic source of that invasive lineage was most likely Michoacán, Mexico.

A series of introduction pathways for exotic avocado pests, including *O. perseae*, from Mexico into the USA have been discussed previously by Hoddle (2005). The key limiting factor for any successful *O. perseae* introduction pathway is that this pest is strictly a foliage feeder and like many other small leaf feeding plant pests introduced into California, it may have been introduced on live plant material (Dowell et al. 2016). The requirement of *O. perseae* for fresh foliage to survive indicates there is minimal risk of *O. perseae* introduction associated with the movement of washed fruit from Mexico to other countries, including California (but see Morse et al. 2009, 2016). Instead, the biology of *O. perseae* and the molecular evidence presented here implies that its introduction from Mexico, presumably Michoacán, into California was most likely mediated through the movement of infested plant material possibly intended for avocado propagation (i.e., budwood or whole plants). Interestingly, Tuttle et al. (1976) first described *O. perseae* from avocado plant material interdicted at a quarantine facility in Texas (USA), which originated from Mexico.

An alternative explanation for the invasion of *O. perseae* into California centers on the recovery of the H8 haplotype from Tijuana in Baja California, Mexico. Tijuana is connected to San Diego California via a pedestrian walkway, and avocados are relatively common in residential gardens in Tijuana and San Diego (Hoddle 2011). The invasion of *O. perseae* into San Diego may have occurred from avocado trees infested with *O. perseae* that were planted in urban areas in Tijuana. *Oligonychus perseae* produces silk strands, which catch the wind and allows mites to disperse aerially (Fig. 7A–C) with the potential to reach neighboring avocado trees (Aponte & McMurtry 1997; Bell et al. 2005). Consequently, *O. perseae* may have dispersed aerially or phoretically (e.g., on humans that may have come in contact with infested plant material) into California and established on trees growing on the USA side of the border (Hoddle 2011). Once established in San Diego, *O. perseae* likely spread to major avocado production areas in California via accidental human-assisted transport of infested plant material and contaminated equipment to uninfested orchards, nurseries, and retail stores.

Molecular data presented here suggests that future explorations for natural enemies of *O. perseae*, for potential introduction into California as part of a classical biological control program, should focus on key areas in Michoacán, i.e., Uruapan, Charo, Morelia, and Tarímbaro. These 4 sites are less than 100 km from each other (Fig. 1) and natural enemies in these areas are likely best adapted to the invasive *O. perseae* haplotype that established in California. Uruapan, in particular, is a major producer of cultivar ‘Hass’ avocados in Michoacán (Salazar-García et al. 2005). Ideally, this search would consist of finding candidate natural enemy species that can subsist year round in avocado orchards, exhibit a high propensity to feed on *O. perseae* when it is available, and are capable of accomplishing density-dependent regulation of *O. perseae* populations. An inventory of natural enemies, primarily predator mites, on avocados in Michoacán already exists (Estrada-Venegas et al. 2002), but to our knowledge, the efficacy of these predators as biological control agents for *O. perseae* within the cultivar ‘Hass’ avocado system has not been evaluated. Field evaluation of phytoseiid mites associated with *O. perseae* in Mexico in combination with the inclusion of additional molecular markers such as microsatellites (Rugman-Jones et al. 2007, 2012), could optimize the geographic search and candidate selection for effective *O. perseae* natural enemies for potential use in a classical biological control program in California.

In addition to providing insight on the putative geographic origin of *O. perseae* populations in California, this study found strong molecular evidence for the occurrence of 3 potential cryptic species within *O.*

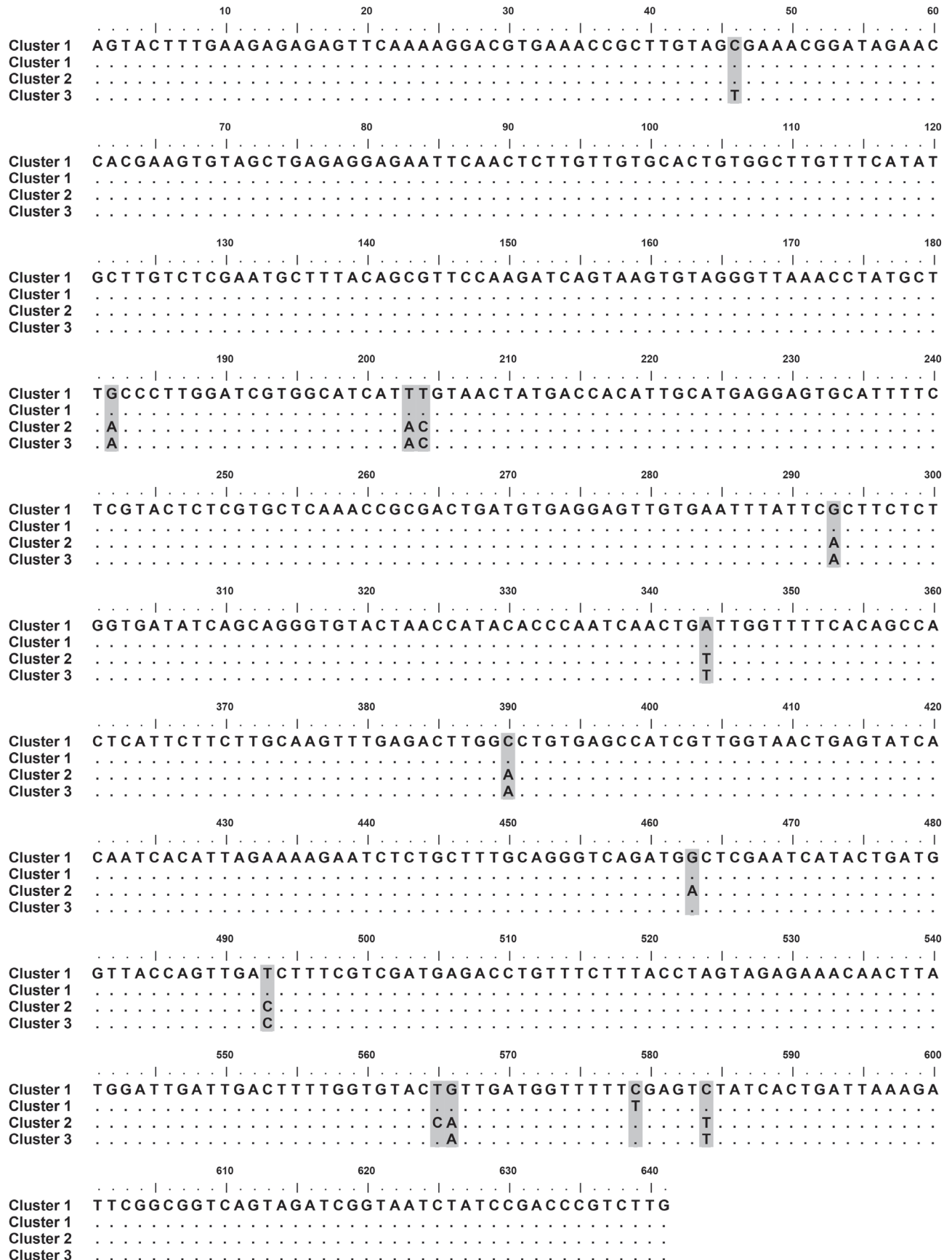

Fig. 5. Sequence variation among 4 28S genotypes identified from *Oligonychus perseae* populations in California, Mexico, and Costa Rica. Genotypes are named according to 3 genetic clusters identified from cytochrome oxidase subunit 1 (*COI*) haplotypes (see Fig. 2).

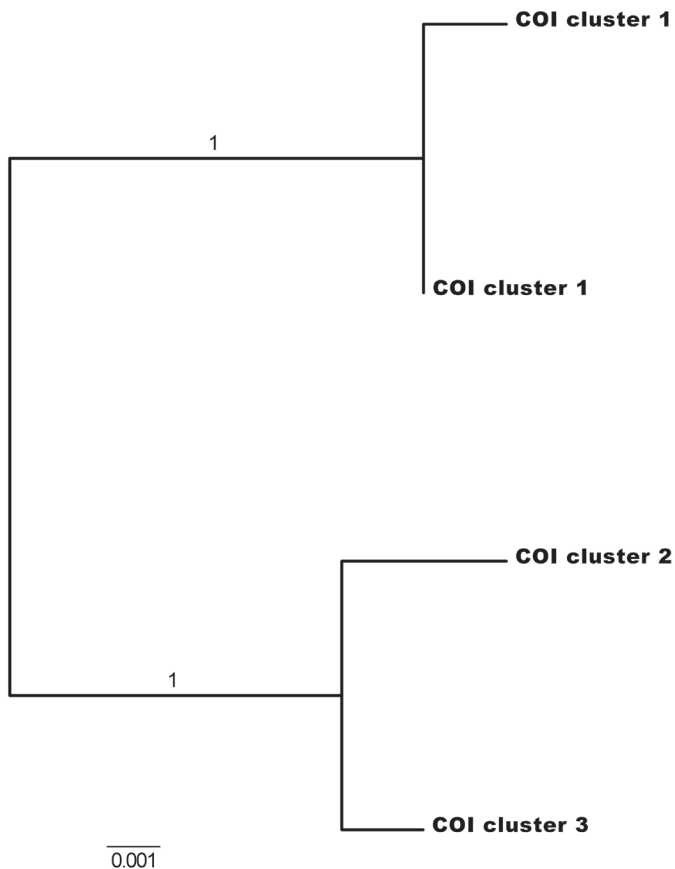

Fig. 6. Divergence in the 28S rRNA region among *Oligonychus perseae* specimens with deeply diverged mitochondrial haplotypes (see Fig. 2). Neighbor-joining tree constructed in MEGA version 6.06. Tree is drawn to scale and branch lengths represent number of base differences per site (p-distance). Bootstrap (1,000 replicates) support shown for major branches.

perseae. Sequences of 2 regions of the nuclear ribosomal cistron (*ITS2* and 28S) and a single mitochondrial gene (*COI*) independently grouped our *O. perseae* specimens into 3 congruent divergent genetic clusters (Figs. 2, 4, and 6). Such correlative clustering across independently evolving nuclear and mitochondrial loci can be seen as strong evidence for the existence of cryptic species (Mallet 1995; Rugman-Jones et al. 2010). Furthermore, in an earlier study of several other *Oligonychus* species, Matsuda et al. (2012) reported non-overlapping intra- and inter-specific thresholds for genetic distances for *COI* (intra: <2.9%, inter: 7.3–18.3%) and 28S (intra: <0.1%, inter: 0.4–10.7%). The genetic distances reported herein for the 3 *COI* and 28S genotype clusters in this study fall within the respective intra- and inter-specific thresholds established by Matsuda et al. (2012). Specifically, within-cluster variation in *COI* was less than 0.5%, and variation between clusters ranged from 7.3 to 8.3%. For 28S, within-cluster variation was almost absent, and variation between clusters ranged from 0.5 to 1.8%. Evidence of cryptic species has previously been reported in 24 superfamilies of Acari, including Tetranychidae (Skoracka et al. 2015). In the context of agricultural systems, the occurrence of cryptic species has been documented in the economically important genus *Tetranychus* (Acari: Tetranychidae) (Matsuda et al. 2013), to which the genus *Oligonychus* is confamilial.

Although we have strong molecular evidence for *O. perseae* being a complex of 3 cryptic species, biological (e.g., interpopulation mating studies) and ecological data (these putative cryptic species occupy near identical niches and cause very similar feeding damage) to sup-

port their status is currently lacking, and we strongly recommend these as future lines of research. Interestingly, Guzmán-Valencia et al. (2017) recently assessed genetic variation among sympatric *O. perseae* and *O. punicae* populations on 6 perennial host trees in the state of México, which included the hardwood species *Salix bonplandiana* Kunth (Salicaceae), *Alnus jorullensis* Kunth (Betulaceae), and *Alnus acuminata* Kunth (Betulaceae), alongside 3 avocado cultivars ('Hass', 'Fuerte', and 'Criollo'). As it relates to our study on avocado, Guzmán-Valencia et al. (2017) found no genetic variation among the *COI* sequences of morphologically-identified *O. perseae* populations sampled from the 3 avocado cultivars. However, examination of their sequences (GenBank accessions KX072889-921; Guzmán-Valencia et al. 2017) reveals levels of divergence between the *COI* of their avocado populations and those they sampled from the 2 *Alnus* species, similar to those reported herein (~8%), suggesting that they may also have encountered 2 cryptic species (in their case, on 2 different types of host plant). Unfortunately, the regions of *COI* used in our study and that of Guzmán-Valencia et al. (2017) do not overlap, and additional genetic marker sequences are not available from Guzmán-Valencia et al. (2017). Thus, it is uncertain whether or not there is overlap in the potential cryptic species reported in the 2 studies. Previously, Guzmán-Valencia et al. (2014) detected similar levels of divergence in *COI* among morphologically identified *O. perseae* populations from the states of México and Michoacán, but again these specimens were not recognized by the authors as potential cryptic species, nor can we be certain how they relate to ours. Combined, these key studies provide very strong evidence for the existence of a cryptic species complex in *O. perseae*, and highlight the importance of considering multiple genetic loci in the assessment of such complexes (i.e., not just *COI*).

Both (Acari: Tetranychidae) *Oligonychus yothersi* (McGregor) and *Oligonychus punicae* (Hirst) have been reported to co-occur with *O. perseae* in some avocado growing regions (Ochoa et al. 1994; Aponte & McMurtry 1997; Lara & Hoddle 2012), but it seems unlikely that the findings of the current study are the result of misidentification. *Oligonychus punicae* is easily separable from *O. perseae* both by gross morphology (*O. punicae* tends to be brown and *O. perseae* is yellow-green) and preferred feeding sites (*O. punicae* generally feeds on the adaxial surface of leaves and *O. perseae* inhabits the abaxial surface of leaves) (Lara & Hoddle 2012). Furthermore, *COI* sequences can be used to clearly separate *O. punicae* from *O. perseae* (Fig. 2; Guzmán-Valencia et al. 2014, 2017). Similar, relatively easy, morphological discrimination also can be made between *O. yothersi* and *O. perseae* (Ochoa et al. 1994) although DNA sequences are not available for the former. Importantly, the *ITS2* sequences of all our Californian and Mexican *O. perseae* specimens (i.e. clusters 1 and 2) clustered with those of specimens from Guzmán-Valencia et al. (2014), the identity of which were all confirmed by morphological taxonomy. With regards to our samples from Costa Rica, our specimens originated from a field site where *O. perseae* was the only species reported based on morphological taxonomy (Solano-Guevara 2011). However, a possibility remains that specimens from Costa Rica that were used in this study (and by extension those from Guzmán-Valencia et al. 2014) could correspond to another species, *Oligonychus peruvianus* (McGregor) (Acari: Tetranychidae), which has previously generated taxonomic confusion due to its very close morphological similarity to *O. perseae* (McMurtry 1993; Sandoval et al. 2011). Unfortunately, no molecular data is currently available for *O. peruvianus* and we were unable to secure authoritatively identified specimens for inclusion in the current study. Ultimately, the insight from our study and Guzmán-Valencia et al. (2014, 2017) highlight the need to develop and validate unambiguous species identification methods for pest mites infesting avocados (Skoracka et al. 2015).

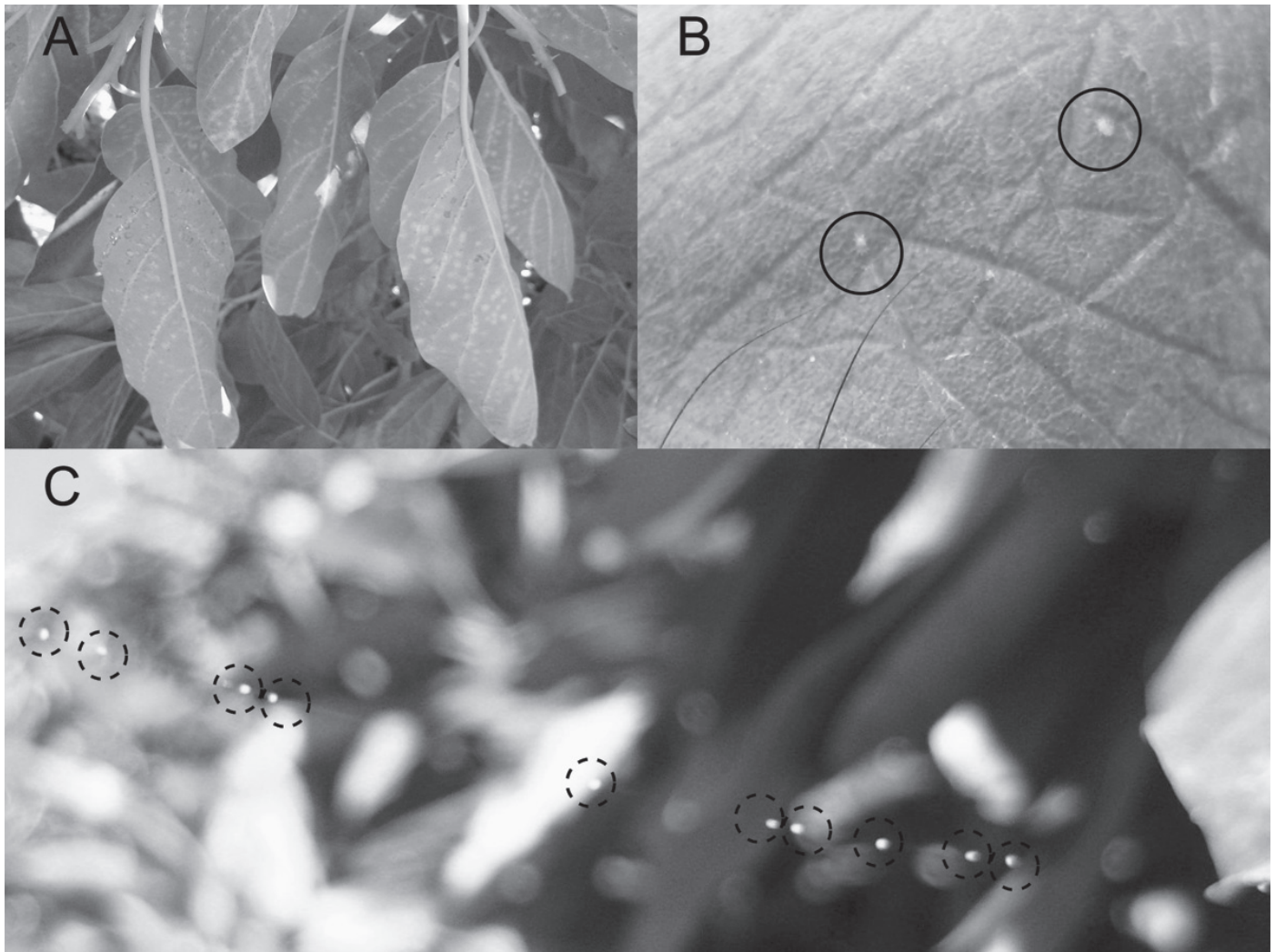

Fig. 7. Local aerial dispersal behavior detected in field populations of *Oligonychus perseae*. **A.** Cultivar ‘Hass’ avocado tree foliage from a commercial orchard in California infested with *O. perseae* as indicated by characteristic necrotic spots on the leaf undersurface. **B.** Adult *O. perseae* being carried by wind currents land on hand and clothes during assessment of mite infestation. **C.** A group of *O. perseae* adults (individual mites within black dashed circles) begins to disperse on a fine silk strand from a cultivar ‘Hass’ avocado leaf. All photographs by JRL.

Acknowledgments

This work was supported in part by the University of California Thelma Hansen Trust and the California Avocado Commission. Additional financial support to JRL was provided by the Robert van den Bosch Scholarship. We thank the numerous growers and homeowners who provided access to their avocado trees for the collection of mite specimens. We are indebted to Dr. Hugo Aguilar Piedra and his research staff for providing transport and generous access to laboratory space in Costa Rica.

References Cited

- Aponte O, McMurtry JA. 1997. Damage on ‘Hass’ avocado leaves, webbing and nesting behaviour of *Oligonychus perseae* (Acari: Tetranychidae). *Experimental and Applied Acarology* 21: 265–272.
- Bell JR, Bohan DA, Shaw EM, Weyman GS. 2005. Ballooning dispersal using silk: world fauna, phylogenies, genetics and models. *Bulletin of Entomological Research*. 95: 69–114.
- Ben-David T, Melamed S, Gerson U, Morin S. 2007. *ITS2* sequences as barcodes for identifying and analyzing spider mites (Acari: Tetranychidae). *Experimental and Applied Acarology* 41: 169–181.
- Bender GS. 1993. A new mite problem in avocados. *California Avocado Society Yearbook* 77: 73–77.
- Boriss H, Brunke H, Kreith M. 2006. Commodity profile: avocados. Agricultural Marketing Resource Center, University of California, Davis, California, <http://aic.ucdavis.edu/profiles/Avocados-2006.pdf> (last accessed 29 May 2017).
- Bost JB, Smith NJH, Crane JH. 2013. History, distribution and uses, pp. 10–30 *In* Schaffer BA, Wolstenholme BN, Whiley AW [eds.], *The Avocado: Botany, Production and Uses*, 2nd edition. Centre for Agriculture and Biosciences International, Boston, Massachusetts.
- CAC (California Avocado Commission). 2015. California Avocado Commission 2014–2015 Annual Report. California Avocado Commission, Irvine, California, <http://www.californiaavocadogrowers.com/sites/default/files/documents/CAC-2014-15-Annual-Report.pdf> (last accessed 29 May 2017).
- Castresana J. 2000. Selection of conserved blocks from multiple alignments for their use in phylogenetic analysis. *Molecular Biology and Evolution* 17: 540–552.
- Chen H, Morrell PL, Ashworth VETM, de la Cruz M, Clegg MT. 2009. Tracing the geographic origins of major avocado cultivars. *Journal of Heredity* 100: 56–65.
- Dereeper A, Guignon V, Blanc G, Audic S, Buffet S, Chevenet F, Dufayard JF, Guindon S, Lefort V, Lescot M, Claverie JM, Gascuel O. 2008. *Phylogeny.fr*:

- robust phylogenetic analysis for the non-specialist. *Nucleic Acids Research* 36: W465–W469.
- Dowell RV, Gill RJ, Jeske DR, Hoddle MS. 2016. Exotic terrestrial macro-invertebrate invaders in California from 1700 to 2015: an analysis of records. *Proceedings of the California Academy of Sciences* 63: 63–157.
- Edgar RC. 2004. MUSCLE: multiple sequence alignment with high accuracy and high throughput. *Nucleic Acids Research* 32: 1792–1797.
- Estrada-Venegas EG, Rodríguez-Navarro S, McMurtry JA. 2002. Some avocado mites from Michoacan Mexico. *International Journal of Acarology* 28: 387–393.
- Guindon S, Dufayard JF, Lefort V, Anisimova M, Hordijk W, Gascuel O. 2010. New algorithms and methods to estimate maximum-likelihood phylogenies: assessing the performance of PhyML 3.0. *Systematic Biology* 59: 307–321.
- Guzmán-Valencia S, Santillán-Galicia MT, Guzmán-Franco AW, González-Hernández H, Carrillo-Benítez MG, Suárez-Espinoza J. 2014. Contrasting effects of geographical separation on the genetic population structure of sympatric species of mites in avocado orchards. *Bulletin of Entomological Research* 104: 610–621.
- Guzmán-Valencia S, Santillán-Galicia MT, Guzmán-Franco AW, Vega-Muñoz R. 2017. Differential host plant-associated genetic variation between sympatric mite species of the genus *Oligonychus* (Acari: Tetranychidae). *Environmental Entomology* 46: 274–283.
- Hall TA. 1999. BioEdit: a user-friendly biological sequence alignment editor and analysis program for windows 95/98/NT. *Nucleic Acids Symposium Series* 41: 95–98.
- Hoddle MS. 2005. Invasions of leaf feeding arthropods: why are so many new pests attacking California-grown avocados? *California Avocado Society Yearbook* 87: 65–81.
- Hoddle MS. 2011. Surveying avocados in the Baja Peninsula for pests that may enter California. California Avocado Commission, Irvine, California, <http://www.californiaavocadogrowers.com/sites/default/files/documents/Surveying-Avocados-in-the-Baja-Peninsula-for-Pests-that-May-Enter-California-August-2011.pdf> (last accessed 29 May 2017).
- Hoddle MS. 2016. Forecasting unintended effects of natural enemies used for classical biological control of invasive species, pp. 130–160 *In* Van Driesche RG, Simberloff D, Blossey B, Causton C, Hoddle MS, Wagner DL, Marks CO, Heinz KM, Warner KD [eds.], *Integrating Biological Control into Conservation Practice*. Wiley Blackwell, Hoboken, New Jersey.
- Hoddle MS, Morse JG. 2012. The perseae mite invasion into California: history, biology, management, and current status. *California Avocado Society Yearbook* 95: 107–137.
- Hoddle MS, Robinson L, Virzi J. 2000. Biological control of *Oligonychus perseae* (Acari: Tetranychidae) on avocado: III. evaluating the efficacy of varying release rates and release frequency of *Neoseiulus californicus* (Acari: Phytoseiidae). *International Journal of Acarology* 26: 203–214.
- Humeres EC, Morse JG. 2005. Baseline susceptibility of perseae mite (Acari: Tetranychidae) to abamectin and milbectin in avocado groves in southern California. *Experimental and Applied Acarology* 36: 51–59.
- Katoh K, Standley DM. 2013. MAFFT multiple sequence alignment software version 7: improvements in performance and usability. *Molecular Biology and Evolution* 30: 772–780.
- Kerguelen V, Hoddle MS. 2000. Comparison of the susceptibility of several cultivars of avocado to the perseae mite, *Oligonychus perseae* (Acari: Tetranychidae). *Scientia Horticulturae* 84: 101–114.
- Lara JR, Hoddle MS. 2012. Sampling guidelines for perseae mite in California avocado orchards. *California Avocado Society Yearbook* 95: 151–173.
- Lara JR, Hoddle MS. 2015a. Pest, present, and future: biological control of spider mites on California-grown avocados, pp. 271–308 *In* Carrillo D, de Moraes GJ, Peña JE [eds.], *Progress in Biological Control: Prospects for Biological Control of Plant Feeding Mites and Other Harmful Organisms*, volume 19. Springer, New York, New York.
- Lara JR, Hoddle MS. 2015b. Comparison and field validation of binomial sampling plans for *Oligonychus perseae* (Acari: Tetranychidae) on Hass avocado in southern California. *Journal of Economic Entomology* 108: 2074–2089.
- Librado P, Rozas J. 2009. DnaSP v5: a software for comprehensive analysis of DNA polymorphism data. *Bioinformatics* 25: 1451–1452.
- Mallet J. 1995. A species definition for the modern synthesis. *Trends in Ecology & Evolution* 10: 294–299.
- Maoz Y, Gal S, Zilberstein M, Izhar Y, Alchanatis V, Coll M, Palevsky E. 2011. Determining an economic injury level for the perseae mite, *Oligonychus perseae*, a new pest of avocado in Israel. *Entomologia Experimentalis et Applicata* 138: 110–116.
- Matsuda T, Hinomoto N, Singh RN, Gotoh T. 2012. Molecular-based identification and phylogeny of *Oligonychus* species (Acari: Tetranychidae). *Molecular Entomology* 105: 1043–1050.
- Matsuda T, Fukumoto C, Hinomoto N, Gotoh T. 2013. DNA-based identification of spider mites: molecular evidence for cryptic species of the genus *Tetranychus* (Acari: Tetranychidae). *Molecular Entomology* 106: 463–472.
- McMurtry JA. 1993. Biological control of mites and greenhouse thrips on avocado. Summary of Avocado Research, Avocado Research Advisory Committee, University of California, Riverside, http://www.avocadosource.com/ARAC/SUM_1993/SYMP_1993_PG_76.pdf (last accessed 29 May 2017).
- McMurtry JA, Johnson HG. 1966. An ecological study of the spider mite *Oligonychus punicae* (Hirst) and its natural enemies. *Hilgardia* 37: 363–402.
- McMurtry JA, de Moraes GJ, Sourassou NF. 2013. Revision of the lifestyles of phytoseiid mites (Acari: Phytoseiidae) and implication for biological control strategies. *Systematic & Applied Acarology* 18: 297–320.
- Morse JG, Rugman-Jones PF, Watson GW, Robinson LR, Bi JL, Stouthamer R. 2009. High levels of exotic armored scales on imported avocados raise concerns regarding USDA–APHIS’ phytosanitary risk assessment. *Journal of Economic Entomology* 102: 855–867.
- Morse JG, Rugman-Jones PF, Woolley JB, Heraty JM, Triapitsyn SV, Hofshi R, Stouthamer R. 2016. Armored scales and their parasitoids on commercial avocados grown in California or imported from Mexico. *Journal of Economic Entomology* 109: 2032–2042.
- Navajas M, Lagnel J, Gutierrez J, Boursot P. 1998. Species-wide homogeneity of nuclear ribosomal *ITS2* sequences in the spider mite *Tetranychus urticae* contrasts with extensive mitochondrial *COI* polymorphism. *Heredity* 80: 742–752.
- Ochoa R, Aguilar H, Vargas C. 1994. *Phytophagous Mites of Central America: an Illustrated Guide*. Centro Agronómico Tropical de Investigación y Enseñanza, Turrialba, Costa Rica.
- Rugman-Jones PF, Hoddle MS, Stouthamer R. 2007. Population genetics of *Scirtothrips perseae*: tracing the origin of a recently introduced exotic pest of Californian avocado orchards, using mitochondrial and microsatellite DNA markers. *Entomologia Experimentalis et Applicata* 124: 101–115.
- Rugman-Jones PF, Hoddle MS, Stouthamer R. 2010. Nuclear-mitochondrial barcoding exposes the global pest western flower thrips (Thysanoptera: Thripidae) as 2 sympatric cryptic species in its native California. *Journal of Economic Entomology* 103: 877–886.
- Rugman-Jones PF, Hoddle MS, Phillips PA, Jeong G, Stouthamer R. 2012. Strong genetic structure among populations of the invasive avocado pest *Pseudocysta perseae* (Hemiptera: Tingidae) reveals the source of introduced populations. *Biological Invasions* 14: 1079–1100.
- Salazar-García S, Zamora-Cuevas L, Vega-López RJ. 2005. Actualización sobre la industria del aguacate en Michoacán, México. *California Avocado Society Yearbook* 87: 45–54.
- Sánchez-Colín S, Mijares-Oviedo P, López-López L, Barrientos-Priego AF. 2001. Historia del aguacate en México. Memoria Fundación Salvador Sánchez Colín CICTAMEX S.C. Coatepec Harinas, México, 1998–2001, 171–187. http://www.avocadosource.com/journals/cictamex/cictamex_1998-2001/CICTAMEX_1998-2001_PG_171-187.pdf (last accessed 29 May 2017).
- Sandoval MF, Aponte O, Vásquez C. 2011. Idiosomal setae analysis in *Oligonychus peruvianus* and *Oligonychus perseae* (Acari: Tetranychidae) from different hosts. *Entomotropica* 26: 127–136.
- Skoracka A, Magalhães S, Rector BG, Kuczyński L. 2015. Cryptic speciation in the Acari: a function of species lifestyles or our ability to separate species. *Experimental and Applied Acarology* 67: 165–182.
- Solano-Guevara M. 2011. Dinámica poblacional de *Oligonychus perseae* Tuttle, Baker y Abbatiello (Acari: Tetranychidae) en *Persea americana* (Mill.) en San Martín de León Cortés, San José, Costa Rica. Thesis, Universidad de Costa Rica, San José, Costa Rica.
- Tamura K, Stecher G, Peterson D, Filipski A, Kumar S. 2013. MEGA6: molecular evolutionary genetics analysis version 6.0. *Molecular Biology and Evolution* 30: 2725–2729.
- Tuttle DM, Baker EW, Abbatiello M. 1976. Spider mites of Mexico (Acarina: Tetranychidae). *International Journal of Acarology* 2: 1–102.
- USDA–APHIS (United States Department of Agriculture–Animal and Plant Health Inspection Service). 2016. Rules and regulations: Mexican Hass avocado import program. Federal Register 81: 33581–33588, <https://www.gpo.gov/fdsys/pkg/FR-2016-05-27/pdf/2016-12586.pdf> (last accessed 29 May 2017).
- USDA–FAS (United States Department of Agriculture–Foreign Agricultural Services). 2015. Mexico Avocado Annual Report: Mexican avocado industry continues to enjoy strong growth. Global Agricultural Information Network report, https://gain.fas.usda.gov/Recent%20GAIN%20Publications/Avocado%20Annual_Mexico%20City_Mexico_11-24-2015.pdf (last accessed 29 May 2017).
- Yee WL, Phillips PA, Rodgers JL, Faber BA. 2001. Phenology of arthropod pests and associated natural predators on avocado leaves, fruit, and in leaf litter in southern California. *Environmental Entomology* 30: 892–898.
- Zappalà L, Kreiter S, Russo A, Garzia GT, Auger P. 2015. First record of the perseae mite *Oligonychus perseae* (Acari: Tetranychidae) in Italy with a review of the literature. *International Journal of Acarology* 41: 97–99.