



Presence or absence of the shell aperture: a criterion to identify shell breakage induced by durophagy in Umbonium (Mollusca: Gastropoda: Trochidae)

Author: Ogaya, Chigusa

Source: Paleontological Research, 8(4) : 311-324

Published By: The Palaeontological Society of Japan

URL: <https://doi.org/10.2517/prpsj.8.311>

BioOne Complete (complete.BioOne.org) is a full-text database of 200 subscribed and open-access titles in the biological, ecological, and environmental sciences published by nonprofit societies, associations, museums, institutions, and presses.

Your use of this PDF, the BioOne Complete website, and all posted and associated content indicates your acceptance of BioOne's Terms of Use, available at www.bioone.org/terms-of-use.

Usage of BioOne Complete content is strictly limited to personal, educational, and non - commercial use. Commercial inquiries or rights and permissions requests should be directed to the individual publisher as copyright holder.

BioOne sees sustainable scholarly publishing as an inherently collaborative enterprise connecting authors, nonprofit publishers, academic institutions, research libraries, and research funders in the common goal of maximizing access to critical research.

Presence or absence of the shell aperture: a criterion to identify shell breakage induced by durophagy in *Umbonium* (Mollusca: Gastropoda: Trochidae)

CHIGUSA OGAYA

Department of Earth and Planetary Science, University of Tokyo, Tokyo 113-0033, Japan (present address: 3-7-5-402 Kohinata, Bunkyo-ku, Tokyo 112-0006, Japan) (email: o.chigusa@nifty.com)

Received September 17, 2002; Revised manuscript accepted October 26, 2004

Abstract. The pattern of shell breakage in the Recent trochid gastropods *Umbonium* (*Suchium*) *moniliferum* (Lamarck) and *U. (S.) giganteum* (Lesson) was observed under durophagous predation by crabs and in tumbling experiments, and the results of these experiments were applied to recent population samples from the natural environment. The experiments were carried out in order to learn if the pattern of shell breakage by durophagy (shell crushing) is different from that induced by water currents and waves. After predation by the predatory crabs *Calappa lophos* (Herbst) and *Portunus trituberculatus* (Miers), shell apertures of *U. (S.) moniliferum* and *U. (S.) giganteum* were broken in a characteristic fashion. In contrast, shells tumbled with sand and artificial seawater rarely lost the apertural margins, although other parts of the shells were relatively severely abraded. These results suggest that a shell from the natural environment with a similarly broken apertural margin was probably attacked by a durophagous crab, and that water currents and waves are not agents that cause breakage of shell apertures. The results were then applied to samples of Recent *U. (S.) moniliferum* from Lake Hamana-ko and fossil *U. (S.) costatum* (Kiener) from the Pleistocene Jizodo Formation in Japan. Shells with broken apertural margins amounted to 60% of all dead empty shells in the sample of Recent *U. (S.) moniliferum*, and over 90% in the sample of Pleistocene *U. (S.) costatum*, suggesting that these shells were extensively preyed upon by durophagous crabs. Shell repair frequencies of Recent *U. (S.) moniliferum*, calculated as a percentage of individuals with one or more repair scars, were 24–55%. The high repair frequencies indicate that considerable numbers of *U. (S.) moniliferum* can escape from attacks by crabs. All the results suggest that shell breakage along the apertural margins of gastropods is a good indicator of durophagy and that broken apertures, as well as shell repairs, are a useful tool for the investigation of predatory-prey interaction.

Key words: Abrasion, durophagy, predation, shell fragments, *Umbonium*

Introduction

Predator-prey interactions have been repeatedly studied using both Recent and fossil gastropods and bivalves, especially since Vermeij proposed two important concepts, the “Mesozoic marine revolution” (Vermeij, 1977) and “escalation” (Vermeij, 1987). Many studies on this subject have been done, mainly focusing on shell repairs induced by sublethal durophagy (on gastropods: Vermeij *et al.*, 1980, 1981, 1982; Schindel *et al.*, 1982; Vale and Rex, 1988; Schmidt, 1989; Allmon *et al.*, 1990; Kropp, 1992; Preston *et al.*, 1993; Ray and Stoner, 1995; Ebbestad and Peel, 1997; Cadée *et al.*, 1997; Dietl and Alexander, 1998; on bivalves: Dietl *et al.*, 2000; Alexander and Dietl, 2001). However, shell repair

frequency does not always represent the intensity of durophagy, as previously pointed out (Vermeij *et al.*, 1982; Schindel *et al.*, 1982; Schmidt, 1989; Ray and Stoner, 1995). For example, a low frequency of shell repair can equally be the result of intense durophagy that was mostly successful as well as the result of rare durophagy. This complexity makes it difficult to evaluate intensity of durophagy and to compare the differences of intensities among samples from different microhabitats or from different ages. To overcome such problems and to better understand the intensity of durophagy and its effects, we need to look for new methods to investigate predator-prey interaction.

To detect and evaluate durophagy on gastropods, this study focused on a specific type of shell breakage, that of the gastropod apertural margin. Apertural

shell breakage induced by durophagy is evidence of successful durophagy, while shell repair after durophagy is evidence of unsuccessful predation.

There have been many reports on durophagy. Durophagous crabs have been observed to crush and/or peel molluscan shells (Shoup, 1968; Elner, 1978; Zipser and Vermeij, 1978; Takeda and Suga, 1979; Elner and Jamieson, 1979; Ozawa, 1981; Vermeij *et al.*, 1982; Hughes and Elner, 1989; Sato, 1992, 1994), birds preying on molluscs produce many shell fragments (Cadée, 1994), and marine vertebrates such as fish, turtles and seals have been reported to prey on and destroy molluscan shells (Carter, 1968). Chave (1964) and Driscoll and Weltin (1973) used laboratory experiments with tumbling barrels to investigate taphonomy. They reported that shells were abraded and their weights were reduced after being tumbled with sedimentary particles in water, but they did not discuss the pattern of shell breakage. Feige and Fürsich (1991), based on semiquantitative field data, concluded that shell fragmentation on sandy tidal flats is mainly caused by biotic activities of durophagous predators and scavengers, not by physical factors. Cate and Evans (1994) reported abundant molluscan shell fragments in sea bottom sediments, produced as a result of predation by fish (*Pogonias cromis*) in Texas coastal bays. Walker *et al.* (2002) confirmed considerable shell breakage in shallow shelf as well as rather deep environments (up to 195 m). These studies support the idea that shell breakage is caused mainly by durophagy rather than by abiotic factors such as water currents during postmortem transportation (Dodd and Stanton, 1990; Meldahl, 2001). However, there is no conclusive evidence to determine what is the main cause of shell breakage in general.

This study, based on laboratory experiments and field observations, aims to identify the cause of shell breakage in Recent trochid gastropods of the genus *Umbonium* and to apply the results to fossil specimens. The hypothesis is that water currents rarely cause apertural shell breakage, and that apertural shell breakage is mainly caused by durophagy. This study should be significant because two different experiments on the process of shell deterioration, *i.e.*, shell breakage by durophagy and shell deterioration by water currents, are directly compared and discussed, using the shells of the same species. This study will also be the first step in testing if apertural shell breakage can be a reliable index of durophagy.

The objectives of this study are: (1) to determine a criterion by which one can distinguish shell breakage induced by durophagy from that induced by water currents, (2) to estimate the degree of shell breakage

and the effect of durophagy among Recent and fossil *Umbonium* populations, and (3) to compare and evaluate shell repair frequency and shell breakage frequency. To accomplish these objectives, I carried out two kinds of laboratory experiments: observation of shell breakage by predatory crabs in an aquarium and shell breakage/abrasion by tumbling experiments. To evaluate the effect of durophagy in the natural environment, I also applied the results to gastropods (living and dead) from a sandy beach and also to the shells from a Pleistocene shallow-water formation.

Through this study, I use “durophagy” instead of “predation” to specify the cause of shell damage by shell crushing. Vermeij *et al.* (1980) defined the term “durophagy” as “predation by shell-crushing” and Aronson (2001) defined it as “the consumption of prey that is protected by a hard skeleton”.

Material and methods

The gastropods used in this study were *Umbonium* (*Suchium*) *costatum* (Kiener), *U. (S.) moniliferum* (Lamarck), and *U. (S.) giganteum* (Lesson), all included in the Trochidae, Archeogastropoda (Figure 1). These three species are common in Honshu and Kyushu of Japan, and they can easily be sampled in quite large numbers. In earlier studies of these species, Ozawa (1981) reported durophagy on *U. (S.) moniliferum* by predatory crabs *Charybdis japonica* (A. Milne-Edwards) and *Portunus pelagicus* (Linnaeus), and Ozawa and Okamoto (1993) estimated phylogenetic relationships of *Umbonium* by integrating fossil records and molecular phylogenetic analysis. Noda *et al.* (1995) and Noda and Nakano (1996) investigated the life history of recent *U. (S.) costatum* at the population level.

The durophagous crabs *Calappa lophos* (Herbst) (Decapoda, Calappidae) and *Portunus trituberculatus*

Species	<i>U. (S.) costatum</i>	<i>U. (S.) moniliferum</i>	<i>U. (S.) giganteum</i>
Maximum shell width	4 cm	2 cm	4 cm
Habitat	infauna, open sea, subtidal, sand	infauna, inner bay, intertidal, sand and mud	infauna, open sea, subtidal, sand
Age	Pleistocene	Recent	Recent

Figure 1. *U. (S.) costatum*, *U. (S.) moniliferum*, and *U. (S.) giganteum* used in this study. Scale bars are 1 cm.

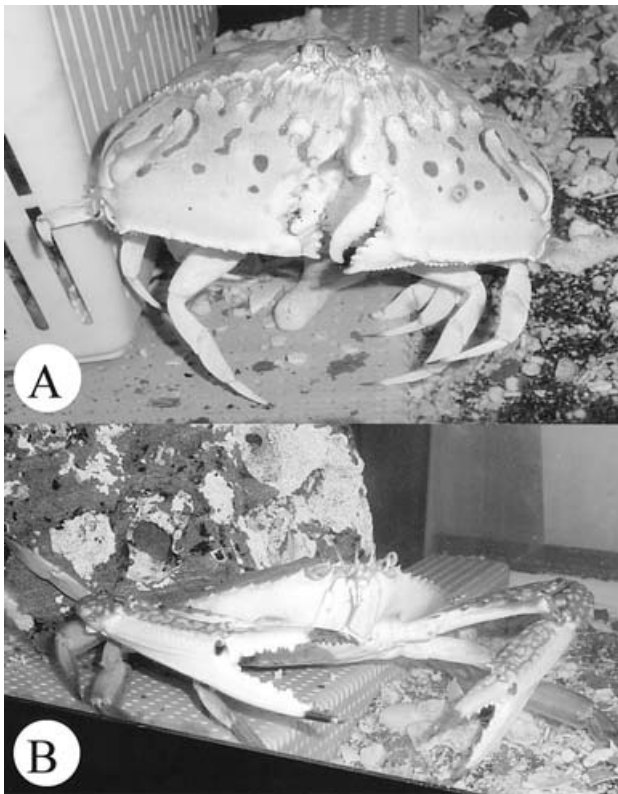

Figure 2. Predatory crabs used in this study. A. The male individual of *C. lophos*. Note the unique shape of both claws, especially the big tubercle on the right claw. B. The male individual of *P. trituberculatus*. Note its slender and jagged claws.

(Miers) (Decapoda, Portunidae) were used in the experiments. *C. lophos* is distributed in shallow waters along the southern coast of Japan. The individual used in this study was an adult male (carapace width 11 cm; Figure 2A). *P. trituberculatus* is one of the best-known durophagous crabs. The species is distributed in shallow waters around Japan. The individual used in this study was an adult male (carapace width 16 cm; Figure 2B).

Two kinds of laboratory experiments were carried out in this study: first, an experiment to detect characteristic patterns of shell breakage caused by durophagous predators, and second, observation of physical deterioration of shells by tumbling barrels. In the latter experiment, the shells were tumbled with coarse-grained sand (1 kg) and seawater (1 l).

Figure 3 shows a flow chart that was used in this study to classify any shells of *U. (S.) moniliferum*, *U. (S.) contatum* and *U. (S.) giganteum* into 11 categories, based on the state of preservation of shells. For instance, a perfectly preserved shell is classified into category 1, and a shell with only its axis preserved is

classified into category 11.

Experiments on durophagy

Experiments on durophagy were done in an aquarium using an individual of *Calappa lophos*, then an individual of *Portunus trituberculatus*. Fifty-five individuals of *U. (S.) moniliferum* were collected from a tidal flat in Kisarazu, on the coast of Tokyo Bay, and forty individuals of *U. (S.) giganteum* were collected from the sandy subtidal coast of Kujukurihama, Chiba Prefecture. All these individuals were kept alive in the aquarium as the prey of the two crabs. For *Calappa lophos*, 15 individuals of *U. (S.) moniliferum* were introduced to the aquarium, and shell conditions were monitored for 17 days. Then 40 individuals of *U. (S.) giganteum* were newly introduced in the aquarium, and the same observations were continued for 16 days. For *Portunus trituberculatus*, 40 individuals of *U. (S.) moniliferum* were introduced to the aquarium, and their shell condition was monitored for 44 days.

When dead shells of *U. (S.) moniliferum* and *U. (S.) giganteum* were found in the aquarium, I examined them to find any unique shell breakage induced by crab durophagy. I regarded broken shells as the product of durophagy, and unbroken dead shells as due to death of the animal from other causes.

Tumbling barrel experiments

Experiments using rolling barrels were carried out to observe shell breakage induced by simulated water currents and wave action, and to estimate their effects. *U. (S.) moniliferum* and *U. (S.) giganteum* were used in these experiments. Two different experiments were carried out: the first (series 1) used fresh and undamaged shells, the second (series 2) used broken shells previously preyed upon by crabs.

Series 1 simulates the taphonomic condition of fresh shells of individuals that died from non-durophagous reasons and were subjected to water currents or waves. For series 1, after 17 living individuals of *U. (S.) moniliferum* and 13 living individuals of *U. (S.) giganteum* died of natural causes, their soft parts were removed by forceps without any chemical treatment.

Series 2 simulates the taphonomic process during post-mortem transportation of broken shells of individuals that died from durophagy. In series 2, 12 living individuals of *U. (S.) moniliferum* and 12 living individuals of *U. (S.) giganteum* were introduced to an aquarium together with *C. lophos* or *P. trituberculatus*, and their shells, after they were preyed on by these predatory crabs, were used for this experiment. The broken shells were put into glass barrels with a maximum inner diameter of 17.5 cm. One liter of artificial

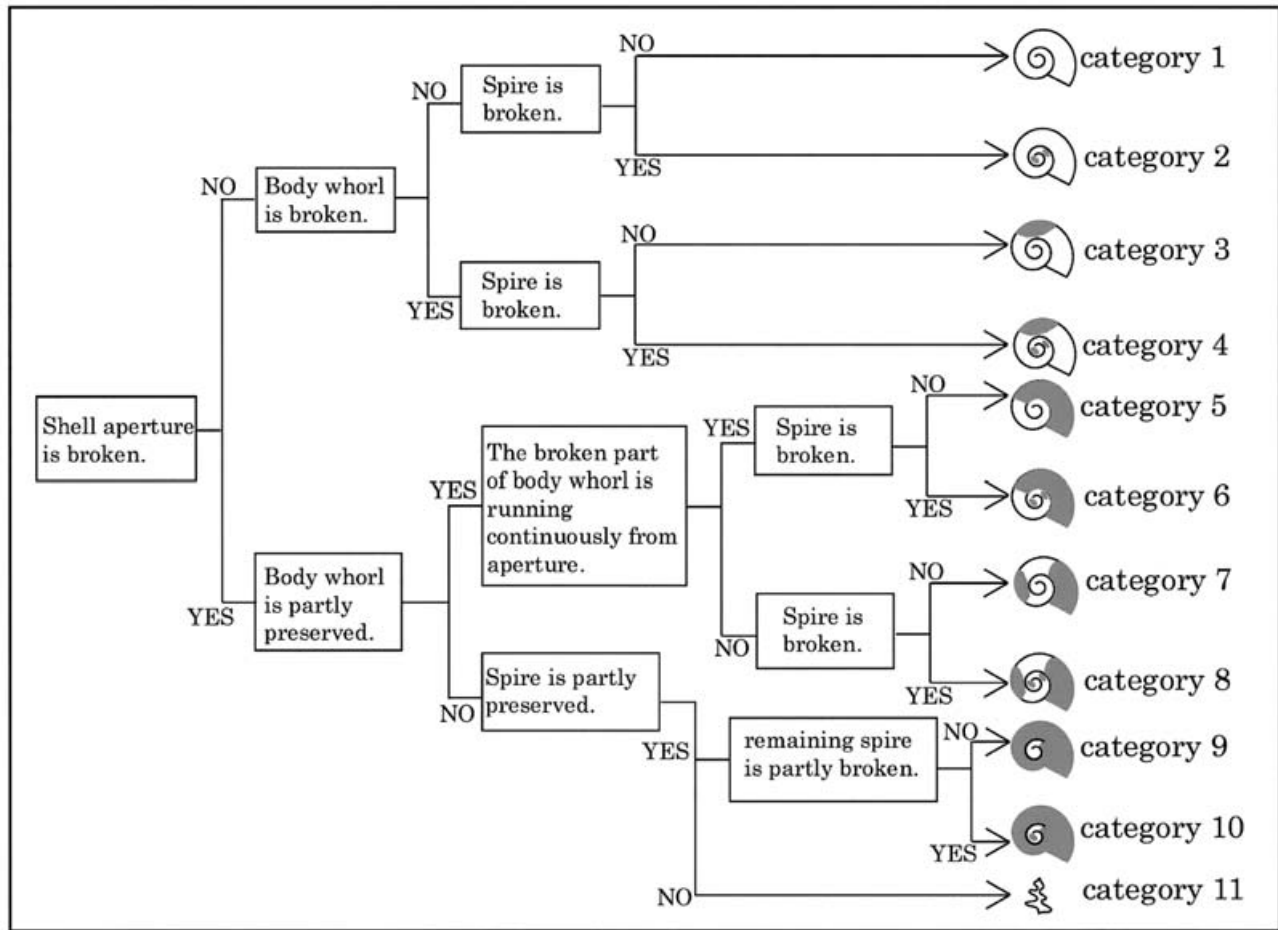

Figure 3. The flowchart that classifies any shells of *U. (S.) moniliferum*, *U. (S.) costatum* and *U. (S.) giganteum* into 11 categories according to their shell condition. All the shells used in this study were classified by this flowchart.

seawater and one kilogram of siliciclastic coarse-grained sand, collected from Araiama beach in Aburatsubo, Kanagawa Prefecture, were added. The glass barrels were placed on a tumbling machine with motor-driven rotating rods of a roller mill, and were tumbled at 35 rpm (Figure 4). Three pieces of rubber (about $1.5 \times 2 \times 10$ cm) were glued to the inner wall of the barrel, in order to induce water agitation. A point on the inner wall is calculated to travel about 27.7 km a day. Tumbling was interrupted periodically, and all the shells were removed from the barrel, in order to check shell condition and to take photographs. Shells were returned to the barrel for continued tumbling.

Results

Experiments on durophagy

Calappa lophos preyed on 13 individuals of *U. (S.)*

moniliferum and broke their shells in the first 17 days, and the crab ate 27 individuals of *U. (S.) giganteum* and broke their shells in the next 16 days. An individual of *Portunus trituberculatus* ate 27 individuals of *U. (S.) moniliferum* and broke their shells in 44 days. Other individuals of *U. (S.) moniliferum* and *U. (S.) giganteum* are assumed to have died for non-durophagous reasons, because they did not show any shell damage, and many still had their soft parts in their shells.

When *C. lophos* preyed on *U. (S.) giganteum*, it grasped and manipulated the shells for several minutes by both chelae and the anterior two pairs of walking legs. Then *C. lophos* held the shell by the left chela and the anterior two pairs of walking legs, and peeled the shell from the outer lip by the right chela, which has a large tubercle on the movable finger. *C. lophos* peeled the body whorl and even some parts of the spire to eat the soft parts. As a result, broken

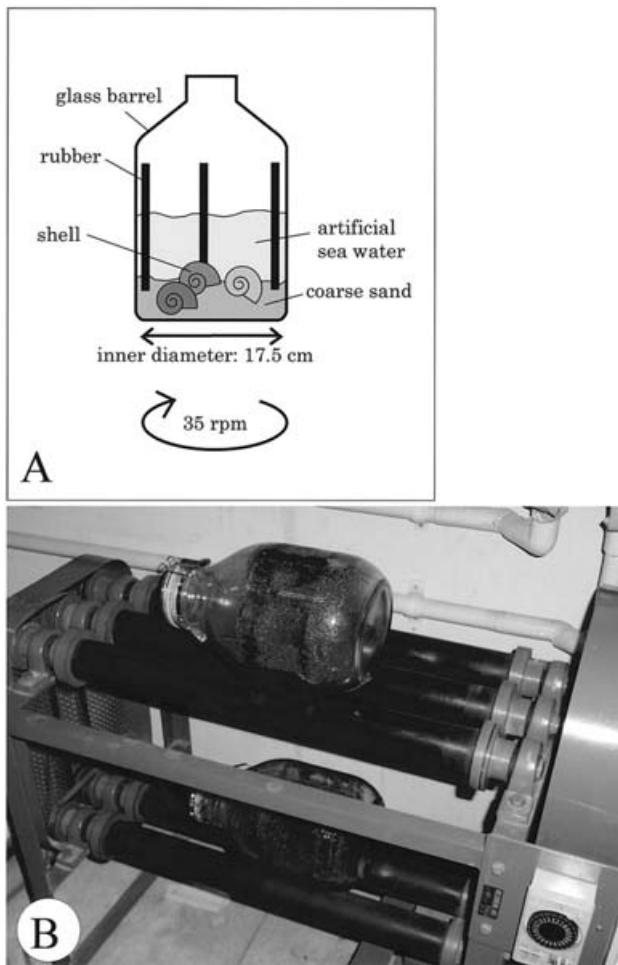

Figure 4. Tumbling experiment. A. Material and procedure. B. Tumbling experiment on the rotating rods of a roller mill.

shells with distinct breakage characteristics were left. All of the broken shells of *U. (S.) moniliferum* and *U. (S.) giganteum* that were preyed on by *C. lophos* lost their outer lips (Figure 5; a–f). The breaks continue spirally from the aperture, and the broken edges were jagged.

The shells of *U. (S.) moniliferum* preyed on by *P. trituberculatus* do not show the spirally peeled breaks such as those produced by *C. lophos* (Figure 5; g–l). Although several parts of the whorl are broken, it is commonly observed that the outer lips of the aperture are broken and that the broken edges are jagged.

Shells of *U. (S.) moniliferum* and *U. (S.) giganteum* preyed on by *C. lophos* and *P. trituberculatus* in the experiments of durophagy were classified mainly into categories 5, 6, 8, 9 and 10 (Table 1).

Experiments using tumbling barrels

U. (S.) moniliferum in series 1 (Figures 6 and 7). – Four out of 17 individuals were not broken even after being tumbled for 24 days, though the other 13 shells lost their whorls to some extent by abrasion. Eleven individuals lost some parts of their shell spires, but kept their body whorls in perfect condition. One individual lost the middle part of the body whorl first, and then its shell aperture. In this specimen, these broken (missing) parts merged into a large breakage, after being tumbled for 24 days. Another individual lost a part of its spire and shell aperture after being tumbled for 4 days. Finally, almost all the shell spire and most parts of its body whorl were lost, and only the part opposite the aperture (a half revolution from the aperture) was left. Thus, even after considerable abrasion, only two individuals lost their apertural margins and the other 15 kept their unbroken apertural margins.

U. (S.) giganteum in series 1 (Figures 6 and 8). – *U. (S.) giganteum* was abraded sooner and more severely than *U. (S.) moniliferum*. All of 13 individuals lost some parts of the shell spire and the parts opposite their apertures in five days. After having been tumbled for 13 days, each individual lost almost all parts of its shell spire and more than half the body whorl, and only the apertural margin was not abraded conspicuously. After 24 days, only one individual lost the aperture by abrasion. All the rest retained the apertural margins, whereas all the other outer surfaces of the whorls were completely lost by abrasion.

U. (S.) moniliferum in series 2 (Figures 6 and 7). – Three of 12 individuals of *U. (S.) moniliferum* were preyed on and broken by *C. lophos*; another 9 individuals were preyed on by *P. trituberculatus*. Before being tumbled, all the shells had lost various shell parts, such as apertures, spines and body whorls, but they all shared one characteristic: their apertures were always broken. When they were tumbled in the barrel, there was no remarkable change in the shells in the beginning, except that the crab-induced jagged edges of breakage become smooth. After being tumbled for eight days, one shell had a new hole in the spire because of abrasion. After being tumbled for 24 days, all the shell edges became rounded, but the shells still retained the periostracum on the shell surface, and kept their original color pattern, showing that shell abrasion was not conspicuous.

U. (S.) giganteum in series 2 (Figures 6 and 8). – Twelve individuals of *U. (S.) giganteum* with spirally broken apertures were used. Broken edges were jagged. All breakage was the result of durophagy by *C. lophos*. Jagged edges became smooth immediately after the start of tumbling. One individual showed

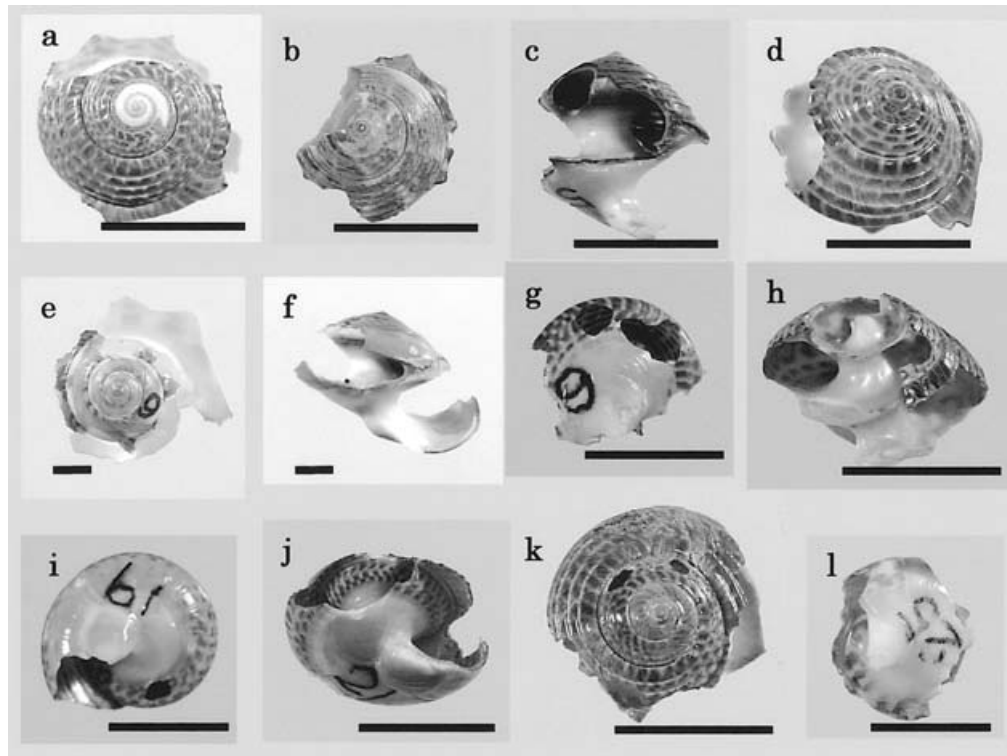

Figure 5. Shells of *U. (S.) moniliferum* (a–d) and *U. (S.) giganteum* (e and f) preyed on by *C. lophos*. They show typical spiral breakage induced by peeling. Note that the apertures of all the shells were destroyed. The shells of *U. (S.) moniliferum* (g–l) preyed on by *P. trituberculatus*. Note that all the apertures were destroyed, and various parts of the whorls were broken. Scale bars are 1 cm.

Table 1. Conditions of shells after the experiments on durophagy. The shells were categorized according to the flowchart (Figure 3). Three individuals of *U. (S.) moniliferum* preyed on by *C. lophos* were excluded, because they were fragmented too finely to be classified.

category	<i>U. (S.) moniliferum</i> preyed on by <i>C. lophos</i>	<i>U. (S.) moniliferum</i> preyed on by <i>P. trituberculatus</i>	<i>U. (S.) giganteum</i> preyed on by <i>C. lophos</i>
1	0	0	0
2	0	0	0
3	0	0	0
4	0	1	0
5	6	2	5
6	2	1	2
7	0	1	0
8	0	22	0
9	0	0	10
10	1	0	8
11	1	0	2
Total	10	27	27

considerable abrasion and a new hole was made on its spire after being tumbled for six days. One after another, new perforations were produced in the spires of other individuals, and the spires became almost entirely abraded after being tumbled for 24 days. The periostracum was also abraded.

All shell deterioration in tumbling was due to abrasion, and I could not observe any shell loss due to cracking and breakage.

Discussion

The results indicate that there is a distinct difference between shell breakage induced by durophagy and that by tumbling experiments. Shells attacked by predatory crabs lost their apertures, and the broken edges were jagged. On the other hand, most shells that were tumbled for 24 days retained their apertural margins, and their broken edges were smooth. The most remarkable difference is whether the aperture is broken or not. The difference in the frequency of individuals with apertures is always conspicuous among *U. (S.) moniliferum* and *U. (S.) giganteum*, and

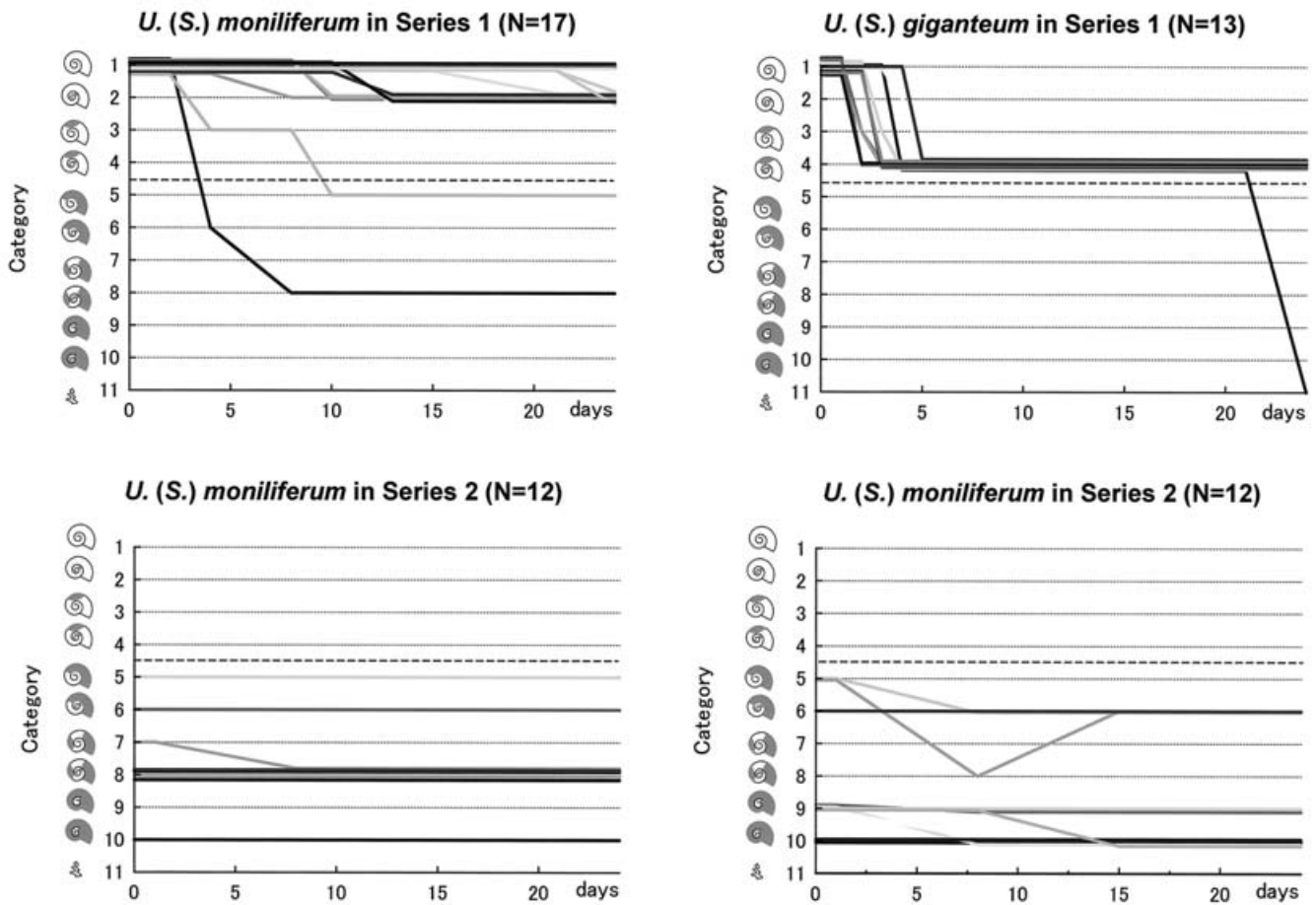

Figure 6. Shell conditions through the tumbling experiments in *U. (S.) moniliferum* and *U. (S.) giganteum*. The graphs show the changes of the shell category with days.

is statistically significant (Figure 9). The differences between the shells preyed on by crabs and those in series 1, and the differences between the shells in series 1 and those in series 2, are both statistically significant, both in *U. (S.) moniliferum* ($p < 0.001$, χ^2 -test and $p < 0.001$, χ^2 -test, respectively) and *U. (S.) giganteum* ($p < 0.01$, Fisher's exact probability test; $p < 0.001$, χ^2 -test, respectively). However, the differences between the shells preyed on by crabs and those in series 2 are not significant in either *U. (S.) moniliferum* ($p > 0.7$, Fisher's exact probability test) or *U. (S.) moniliferum* ($p = 1$, Fisher's exact probability test). In these tests, some did not satisfy necessary conditions of the χ^2 -test, and Fisher's exact probability test was used for these cases.

The observation of aperture breakage induced by durophagy is consistent with the previous reports. Shoup (1968) reported that *Calappa hepatica* (Linn.), *C. calappa* (Linn.) and *C. angusta* (A. Milne-Edwards), *C. flammea* (Herbst), *C. gallus* (Herbst), *C.*

ocellata (Holthuis), and *C. sulcata* (Rathbun) opened gastropod shells in a relatively consistent way. These crabs rolled and held the shells with the two chelae and the first two pairs of legs, then they inserted a dactyl into the apertures and broke them to eat the soft parts. Zipser and Vermeij (1978) observed the crushing behavior of predatory crabs in the laboratory, and described it in detail. In their experiments, 122 shells from 11 gastropod species were preyed on by 17 individual crabs (one parthenopid and five xanthid species). As a result, 69 shells were broken at or near the apertures, 26 were wholly crushed, 18 were broken in other parts, and nine were not broken. Large shells were more apt to be broken near the apertures than small ones. This result indicates the tendency of predatory crabs to attack near the apertural margins. There are also many other observations of durophagy of molluscan shells by crabs (Takeda and Suga, 1979, *Calappa gallus capellonnis* on *Thais clavigera*; Ozawa, 1981, *Portunus pelagicus* and *Chary-*

Series 1

Series 2

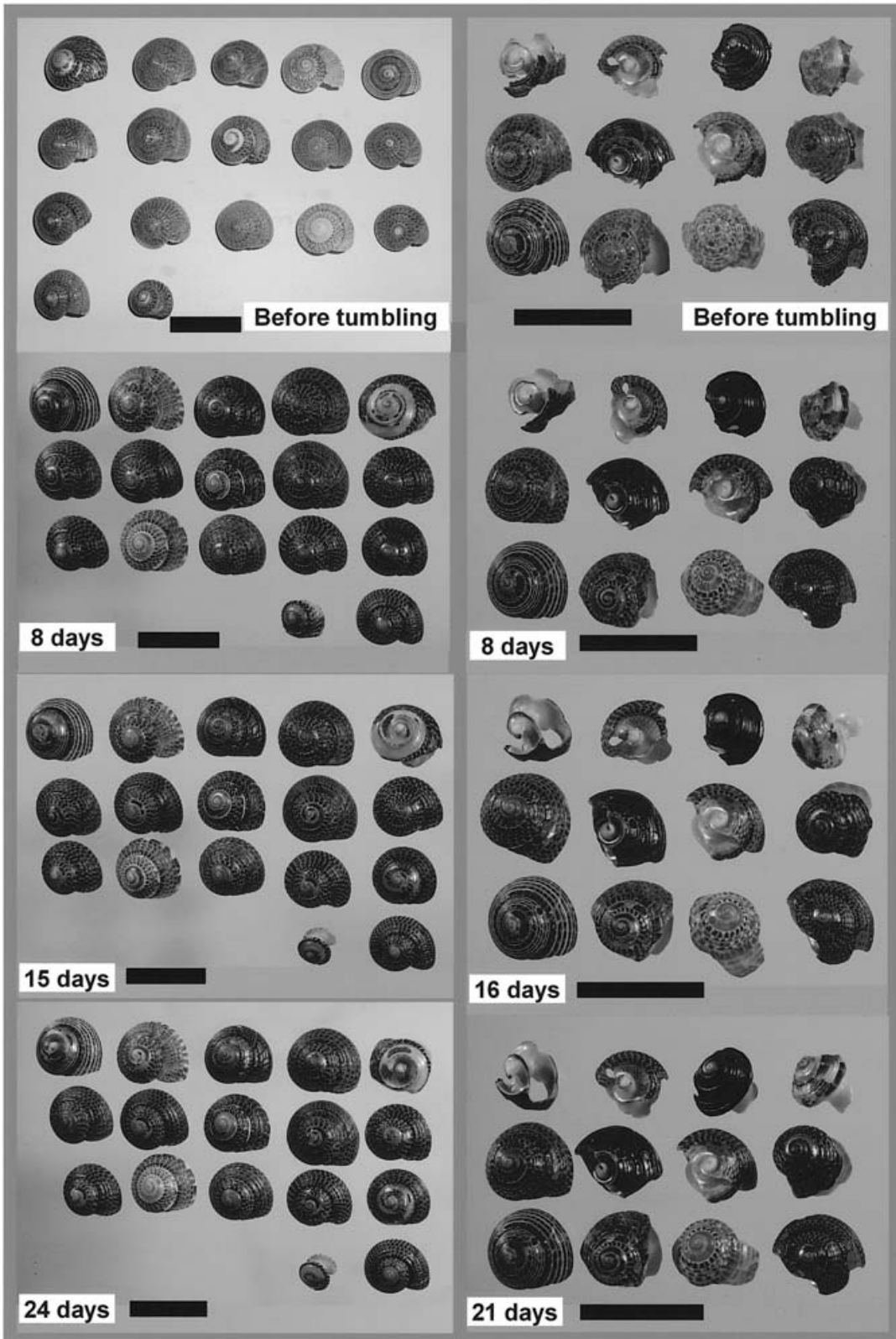

bdis japonica on *U. (S.) moniliferum*; Vermeij *et al.*, 1982, *Calappa hepatica* on *Rhinoclavis aspera*, *R. fasciata*, *Terebra affinis*, *Strombus gibberulus*; Sato, 1992, five portunid crabs on *Littorina brevicula*; Sato 1994, *Portunus (Portunus) pelagicus* on *Littorina brevicula* and *Batillaria cumingii*). All these earlier works agree with the present study: the predatory crabs typically break the apertures of shells. Aperture breakage is a common characteristic in both laboratory and field observations.

In contrast, results of the present tumbling experiments show that the apertures are generally more durable against tumbling than other shell parts. The durability of apertures is probably related to shell thickening there. Tumbling experiments by Chave (1964), and Driscoll and Weltin (1973) focused on shell abrasion and loss of shell weight during tumbling, and did not refer to shell breakage. However, Driscoll and Weltin (1973) showed photographs of abraded shells after having been tumbled with sands and water for 1700 hours. Thirteen individuals of an Atlantic oyster drill *Urosalpinx cinerea* and a mud snail *Nassarius obsoletus* retained their apertures after being subjected to severe abrasion in their spires and body whorls. Only a few individuals lost their apertures during their tumbling experiment.

In contrast to the relatively robust shells of *U. (S.) moniliferum*, the shells of its congener *U. (S.) giganteum* showed much faster abrasion. This implies that *U. (S.) giganteum* has physically weaker shells than *U. (S.) moniliferum*. The reason for such a difference is not clear at present. *Calappa* attacked and ate both species, and *U. (S.) giganteum* does not appear to produce any distasteful or poisonous matter to deter predators. However, the habitats of the two species are different, suggesting that the predation pressure on *U. (S.) giganteum* might be lower than that on *U. (S.) moniliferum*.

The present study and the other earlier works strongly suggest that by observing shell breakage we can determine fairly reliably whether a shell was broken by durophagy or by water currents. If a shell has a broken apertural margin, the animal probably died from durophagy by a crab. If a shell retains an unbroken apertural margin, the animal probably did not die from durophagy by a crab. Further, if the broken edges are jagged, the shell must have been transported or reworked very little. If the broken edges are smooth, the shell must have been trans-

ported before burial or reworked by water currents. If a shell has perforations in its spire or its body whorl, death probably resulted from non-durophagous reasons and the shell was transported by water currents before burial. Such perforations in these shells are apparently different from those made by drilling gastropods in their shapes.

As a case study of shell breakage in natural environments, degrees and conditions of shell breakage were investigated using Recent *U. (S.) moniliferum* and Pleistocene *U. (S.) costatum*. Recent *U. (S.) moniliferum* were sampled on a sandy intertidal coast of Lake Hamana-ko, Shizuoka Prefecture (Figure 10). The shell-rich sediments (1 m length \times 1 m width \times 10 cm depth) were sampled and washed through a sieve (4 mm), and the remaining living and dead individuals of *U. (S.) moniliferum* were all collected and brought back to the laboratory. Fossil *U. (S.) costatum* were sampled from the Upper Pleistocene Jizodo Formation, Shimosa Group, Chiba Prefecture (Figure 10). Most of the fossils appear to be allochthonous, because they occur in cross-stratified shell beds and many of them show some degree of shell abrasion. *U. (S.) costatum* lives on intertidal to shallow subtidal sandy bottoms, therefore they might have been living in the same sedimentary environment as the beds deposited, and might not have been transported for a long distance. The shell condition of *U. (S.) costatum* varies from well preserved to almost broken. After cleaning, specimens without apex or umbilicus were excluded, because they might duplicate the same specimens. All these Recent and fossil shells were classified into 11 categories and were counted based on the flowchart shown in Figure 3, and the numbers of individuals used and the numbers of individuals classified into each category are shown in Table 2.

Shells without aperture margins (belonging to the categories 5–11) amounted to about 65% of all empty shells in the sample of Recent *U. (S.) moniliferum* from Lake Hamana-ko. More than 95% of fossil *U. (S.) costatum* from the Upper Pleistocene have broken apertures (categories 5–11). Shells with broken apertures are assumed to have died from durophagy. The high percentages of shells without apertural margins indicate that Recent *U. (S.) moniliferum* and Pleistocene *U. (S.) costatum* were frequently preyed on by durophagous crabs.

Shell repair and shell breakage frequencies were calculated in the sample of *U. (S.) moniliferum* from

◆ **Figure 7.** Seventeen individuals of *U. (S.) moniliferum* in the series 1 of the experiments using tumbling barrels (left) and twelve individuals in the series 2 (right). The scale bars are 2 cm.

Series 1

Series 2

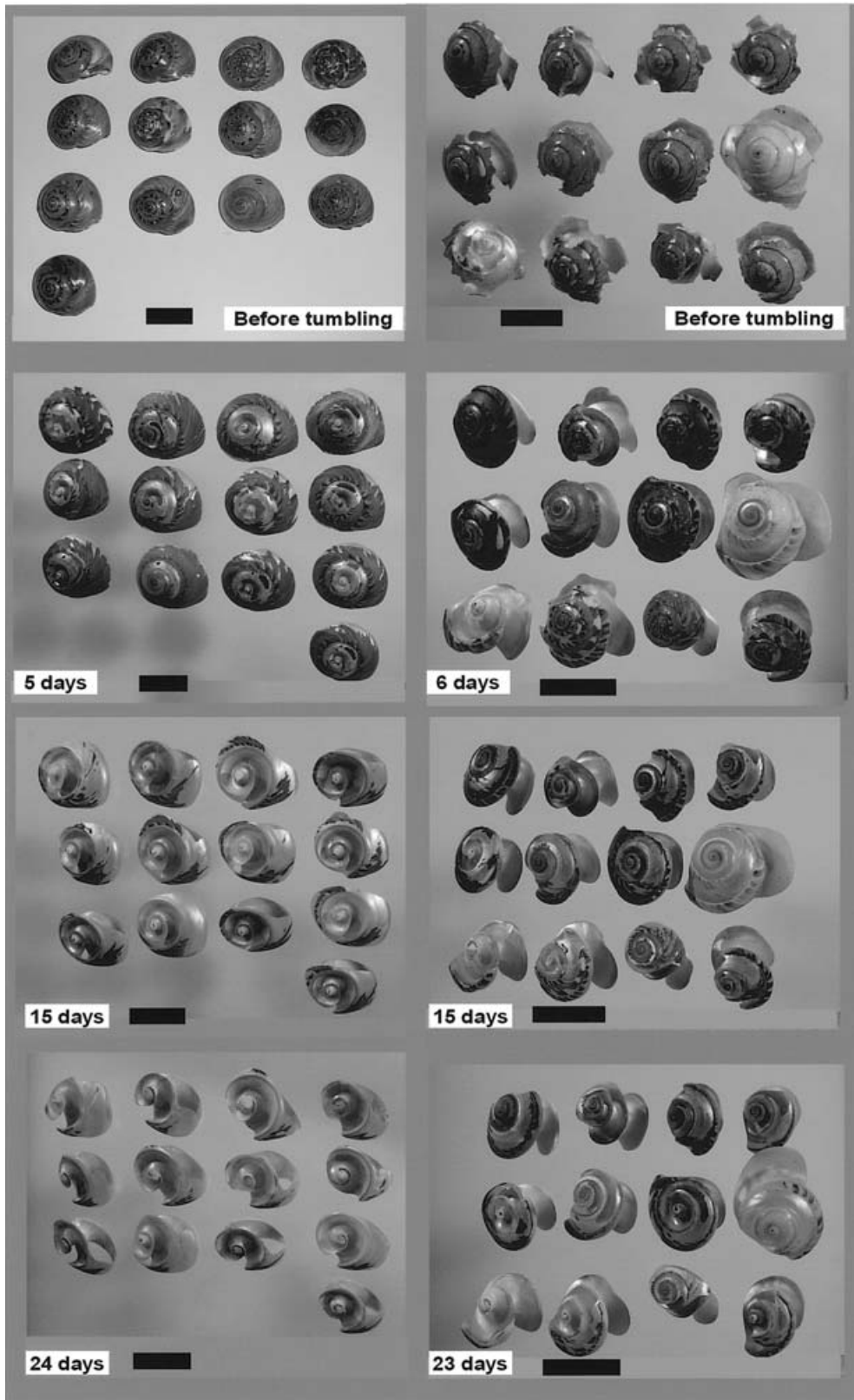

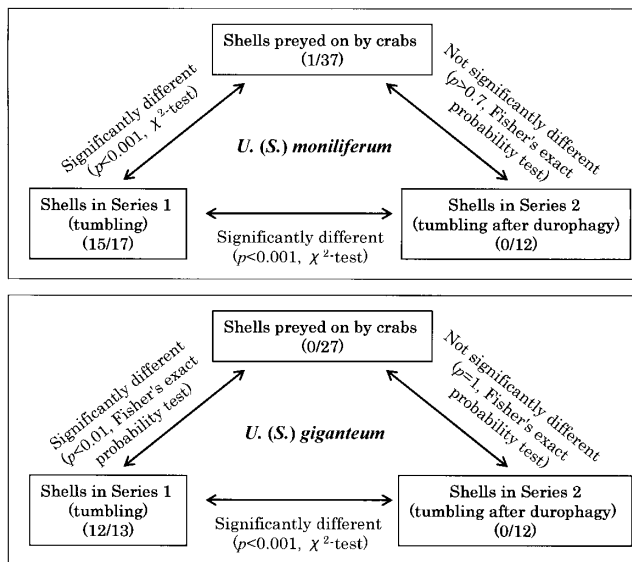

Figure 9. The differences of the ratios of shells with broken apertures to all the shells. The differences between the shells preyed on by crabs in the experiments on durophagy, the shells in series 1 of the experiments using tumbling barrels, and the shells in series 2 are statistically checked. The numbers signify (shells with broken apertures/all the shells). The numbers of series 1 and series 2 are after being tumbled for 24 days.

Lake Hamana-ko, and the two frequencies were compared to each other. All the shells of living individuals and the unbroken empty shells were observed through a binocular microscope. In these observations, shell repair frequency is defined as the percentage of shells with at least one repair in the total sample. This way of counting shell repair frequency was used in Vale and Rex (1988), Kropp (1992) and Cadée *et al.* (1997). The shell repair frequency of living shells of *U. (S.) moniliferum* from Lake Hamana-ko was 54.5%, and that of unbroken empty shells was 24.0%. The difference between the two frequencies is statistically significant ($p < 0.001$, χ^2 -test). The reason for this difference is not clear, but it may be due to changing intensity of durophagy in different times. The shell breakage frequency of dead shells, namely the percentage of the shells with broken apertures, was 65%, suggesting that durophagy was the main cause of death.

Shell repairs are assumed to be caused by sublethal durophagy that damaged the apertures. That is, a shell with shell repair(s) demonstrates that it has experienced at least one attack by durophagous predators,

and that the individual could escape from that attack. For *U. (S.) moniliferum* from Lake Hamana-ko, about 45% of the living individuals have never experienced minor shell breakage, and similarly 76% of the unbroken dead empty shells (shells of individuals that died of non-durophagous causes) have never experienced even minor shell breakage when alive. About 35% of all the dead empty shells probably represent deaths from non-durophagous causes. Assuming that the empty dead shells with apertural margins preserved have shell repairs as frequent as the unbroken dead empty shells, 76% of the dead empty shells with perfectly preserved apertures never experienced durophagy, both when the animals were alive and when they died. Approximately 27% (76% of 35%) of all empty shells were never attacked by durophagous predators. Furthermore, if a dead empty shell that keeps its apertural margin has a shell repair, it must have survived attacks by durophagous predators while the cause of death was not durophagy. Similarly, about 8% (24% of 35%) of all empty shells received at least one durophagous attack on the shell and survived. Potentially these individuals could play an important role in the evolution of *Umbonium* from the viewpoint of anti-predatory strategy, such as escape behavior, because they may have been better adapted to intense durophagy than others.

This study suggests strongly that, based on the mode of shell preservation, the cause of shell breakage can be distinguished. Whether a shell aperture is broken or unbroken is critically important. This criterion can be used at least in the case of *U. (S.) moniliferum* and *U. (S.) giganteum*, and other previous studies also suggest that it is probably applicable to other gastropods in general. For example, the percentage of shells with broken apertures can be a clue to estimating frequency of death by durophagous crabs. Also, the intensity and success rates of durophagy can be compared among populations from different habitats or from different time intervals. By focusing on shell breakage of fossil shell assemblages, the ecological and morphological evolution of gastropods against durophagous crabs through geological times could be discussed.

Conclusions

1. The shells of *U. (S.) moniliferum* and *U. (S.) giganteum* preyed on by *C. lophos* and *P. tritu-*

← **Figure 8.** Thirteen individuals of *U. (S.) moniliferum* in the series 1 in the experiments using tumbling barrels (left) and twelve individuals in the series 2 (right). Scale bars are 2 cm.

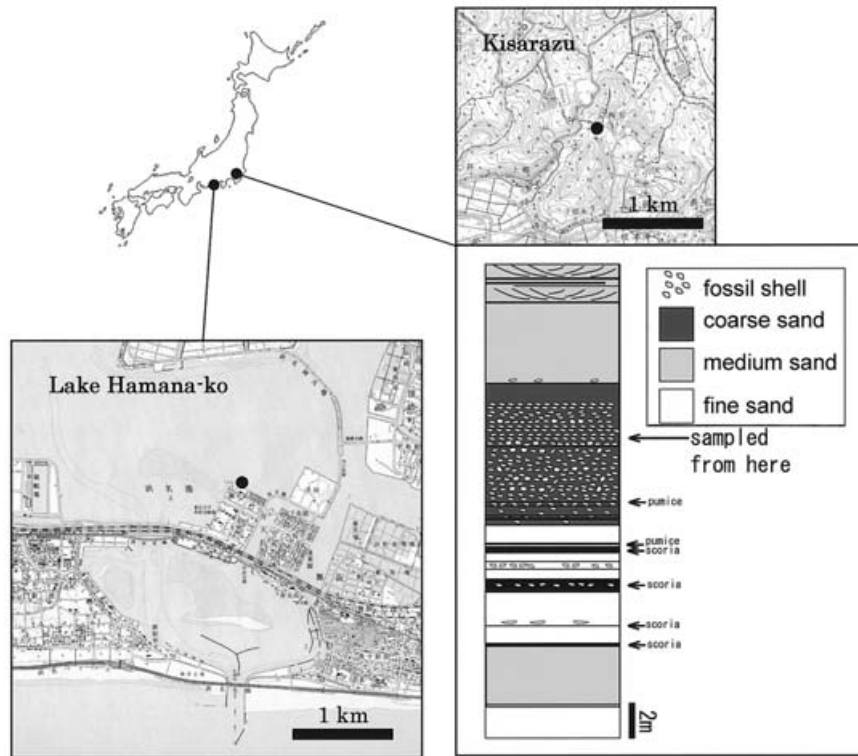

Figure 10. Locality map of Recent *U. (S.) moniliferum* in Lake Hamana-ko (left), and locality map and columnar section of *U. (S.) costatum* from the upper Pleistocene Jizodo Formation in Nishiyatsu, Kisarazu (right).

Table 2. Numbers of sampled shells used in the analysis of shell breakage in natural environments. Recent shells of *U. (S.) moniliferum* were collected from Lake Hamana-ko and fossil shells of *U. (S.) costatum* from the Upper Pleistocene Jizodo Formation.

	Recent <i>U. (S.) moniliferum</i>	Fossil <i>U. (S.) costatum</i>
Living individuals	343	–
Dead shells used by hermit crabs	42	–
Category 1	392	9
Category 2	14	0
Category 3	35	2
Category 4	24	1
Category 5	270	74
Category 6	73	12
Category 7	46	25
Category 8	156	12
Category 9	16	46
Category 10	35	26
Category 11	241	100
Total	1687	307

- berculatus* were broken at their apertures.
- Apertural margins of the shells of *U. (S.) moniliferum* and *U. (S.) giganteum* tumbled for over 20 days with sands and seawater did not show considerable abrasion.
- A shell with broken apertural margin must have died of durophagy, and a shell with unbroken apertural margin must have died of a non-durophagous reason.
- The percentages of shells with broken apertures are high both in Recent *U. (S.) moniliferum* and Pleistocene *U. (S.) costatum*.
- Shell breakage together with shell repairs enables us to discuss interaction between prey and durophagous predators in more detail.

Acknowledgments

I thank T. Oji for his support and advice throughout this study. I also thank T. Atsuzawa for kindly providing me with individuals of *Calappa lophos*, and S. Ogihara for the use of a roller mill. D.L. Meyer and J. Cooper reviewed this paper and improved the English of the text. G.J. Vermeij gave me valuable comments

on the early version of the manuscript. T. Shibata greatly supported me in sampling of fossil material. K. Tanabe, K. Endo, T. Sasaki, I. Sarashina, T. Sato and colleagues in the Paleobiological Seminar, University of Tokyo gave me valuable suggestions for this study. I thank two reviewers, S.E. Walker and M. Kowaleski, for their careful reading and for the improvement of the manuscript.

References

- Alexander, R. R. and Dietl, G. P., 2001: Shell repair frequencies in New Jersey bivalves: a recent baseline for tests of escalation with Tertiary, Mid-Atlantic congeners. *Palaeos*, vol. 16, p. 354–371.
- Allmon, W. D., Nieh, J. C. and Norris, R. D., 1990: Drilling and peeling of turrilline gastropods since the Late Cretaceous. *Palaeontology*, vol. 33, p. 595–611.
- Aronson, R. B., 2001: Durophagy in marine organisms. In, D. E. G. Briggs and P. R. Crowther eds., *Palaeobiology 2*, p. 393–397. Blackwell Science, London.
- Cadée, G. C., 1994: Eider, shelduck, and other predators, the main producers of shell fragments in the Wadden sea: palaeoecological implications. *Palaeontology*, vol. 37, p. 181–202.
- Cadée, G. C., Walker, S. E. and Flessa, K. W., 1997: Gastropod shell repair in the intertidal of Bahia la Choya (N. Gulf of California). *Palaeogeography, Palaeoclimatology, Palaeoecology*, vol. 136, p. 67–78.
- Carter, R. M., 1968: On the biology and paleobiology of some predators of bivalved Mollusca. *Palaeogeography, Palaeoclimatology, Palaeoecology*, vol. 4, p. 29–65.
- Cate, A. S. and Evans, I., 1994: Taphonomic significance of the biomechanical fragmentation of live molluscan shell material by a bottom-feeding fish (*Pogonias cromis*) in Texas coastal bays. *Palaios*, vol. 9, p. 254–274.
- Chave, K. E., 1964: Skeletal durability and preservation. In, J. Imbrie and N. Newell eds., *Approaches to Paleocology*, p. 377–387. John Wiley & Sons, New York.
- Dietl, G. P. and Alexander, R. R., 1998: Shell repair frequencies in whelks and moon snails from Delaware and southern New Jersey. *Malacologia*, vol. 39, p. 151–165.
- Dietl, G. P., Alexander, R. R. and Bien, W. F., 2000: Escalation in Late Cretaceous-early Paleocene oysters (Gryphaeidae) from the Atlantic Coastal Plain. *Paleobiology*, vol. 26, p. 215–237.
- Dodd, J. R. and Stanton, R. J., 1990: *Paleoecology: concepts and applications*. 2nd ed, 400p. John Wiley & Sons, New York.
- Driscoll, E. G. and Weltin, T. P., 1973: Sedimentary particles as factors in abrasive shell reduction. *Palaeogeography, Palaeoclimatology, Palaeoecology*, vol. 13, p. 275–288.
- Ebbestad, J. O. R. and Peel, J. S., 1997: Attempted predation and shell repair in Middle and Upper Ordovician gastropods from Sweden. *Journal of Paleontology*, vol. 71, p. 1007–1019.
- Elnor, R. W., 1978: The mechanics of predation by the shore crab, *Carcinus maenas* (L.), on the edible mussel, *Mytilus edulis* L. *Oecologia*, vol. 36, p. 333–344.
- Elnor, R. W. and Jamieson, G. S., 1979: Predation of sea scallops, *Placopecten magellanicus*, by the rock crab, *Cancer irroratus*, and the American lobster, *Homarus americanus*. *Journal of the Fisheries Research Board of Canada*, vol. 36, p. 537–543.
- Feige, A. and Fürsich, F. T., 1991: Taphonomy of the Recent molluscs of Bahia la Choya (Gulf of California, Sonora, Mexico). *Zitteliana*, vol. 18, p. 89–133.
- Hughes, R. N. and Elnor, R. W., 1989: Foraging behaviour of a tropical crab: *Calappa ocellata* Holthuis feeding upon the mussel *Brachidontes domingensis* (Lamarck). *Journal of Experimental Marine Biology and Ecology*, vol. 133, p. 93–101.
- Kropp, R. K., 1992: Repaired shell damage among soft-bottom mollusks on the continental shelf and upper slope north of Point Conception, California. *Veliger*, vol. 35, p. 36–51.
- Meldahl, K. H., 2001: Shells. In, D. E. G. Briggs and P. R. Crowther eds., *Palaeobiology 2*, p. 262–264. Blackwell Science, London.
- Noda, T., Nakao, S. and Goshima, S., 1995: Life history of the temperate subtidal gastropod *Umbonium costatum*. *Marine Biology*, vol. 122, p. 73–78.
- Noda, T. and Nakao, S., 1996: Dynamics of an entire population of the subtidal snail *Umbonium costatum*: the importance of annual recruitment fluctuation. *Journal of Animal Ecology*, vol. 65, p. 196–204.
- Ozawa, T., 1981: Predators of *Suchium moniliferum* (Gastropoda, Trochidae), with emphasis on the predation by portunid crabs. *Venus*, vol. 39, p. 225–235. (in Japanese with English abstract)
- Ozawa, T. and Okamoto, K., 1993: A new movement of phylogeny by synthesis of paleontological approach and molecular phylogenetical approach, from an example of gastropods *Umbonium*. *Gekkan Tikyu*, vol. 15, p. 589–595. (in Japanese)
- Preston, S. J., Roberts, D. and Montgomery, W. I., 1993: Shell scarring in *Calliostoma zizyphinum* (Prosobranchia: Trochidae) from Strangfoed Lough, Northern Ireland. *Journal of Molluscan Studies*, vol. 59, p. 211–222.
- Ray, M. and Stoner, A. W., 1995: Predation on a tropical spinose gastropod: the role of shell morphology. *Journal of Experimental Marine Biology and Ecology*, vol. 187, p. 207–222.
- Sato, T., 1992: Experimental study of predation by portunid crabs onto shallow marine molluscs and its paleobiological implications. Unpublished graduation thesis submitted to the University of Tokyo.
- Sato, T., 1994: Predatory behavior and morphological variations of *Portunus (P.) trituberculatus* (Crustacea: Decapoda) and their implications on the escalation of predatory-prey relationship. Unpublished Master's thesis submitted to the University of Tokyo.
- Schindel, D. E., Vermeij, G. J., and Zipser, E., 1982: Frequencies of repaired shell fractures among the Pennsylvanian gastropods of north-central Texas. *Journal of Paleontology*, vol. 56, p. 729–740.
- Schmidt, N., 1989: Paleobiological implications of shell repair in Recent marine gastropods from the northern Gulf of California. *Historical Biology*, vol. 3, p. 127–139.
- Shoup, J. B., 1968: Shell opening by crabs of the genus *Calappa*. *Science*, vol. 160, p. 887–888.
- Takeda, M. and Suga, H., 1979: Feeding habits of box crabs, *Calappa*. *Researches on Crustacea*, vol. 9, p. 43–46. (in Japanese with English abstract)

- Vale, F.K. and Rex, M.A., 1988: Repaired shell damage in deep-sea prosobranch gastropods from the western north Atlantic. *Malacologia*, vol. 28, p. 65–79.
- Vermeij, G.J., 1977: The Mesozoic marine revolution: evidence from snails, predators and grazers. *Paleobiology*, vol. 3, p. 245–258.
- Vermeij, G.J., 1987: *Evolution and Escalation: An Ecological History of Life*, 528p. Princeton University Press, Princeton.
- Vermeij, G.J., Schindel, D.E. and Zipser, E., 1981: Predation through geological time: evidence from gastropod shell repair. *Science*, vol. 214, p. 1024–1026.
- Vermeij, G.J., Zipser, E. and Dudley E.C., 1980: Predation in time and space: peeling and drilling in terebrid gastropods. *Paleobiology*, vol. 6, p. 352–364.
- Vermeij, G.J., Zipser, E. and Zardini, R., 1982: Breakage-induced shell repair in some gastropods from the Upper Triassic of Italy. *Journal of Paleontology*, vol. 56, p. 233–235.
- Walker, S.E., Parsons-Hubbard, K., Powell, E. and Brett, C.E., 2002: Predation on experimentally deployed molluscan shells from shelf to slope depths in a tropical carbonate environment. *Palaios*, vol. 17, p. 147–170.
- Zipser, E. and Vermeij, G.J., 1978: Crushing behavior of tropical and temperate crabs. *Journal of Experimental Marine Biology and Ecology*, vol. 31, p. 155–172.