

## **Discovery of Two Rare Species of Stalked Crinoids from Okinawa Trough, Southwestern Japan, and Their Systematic and Biogeographic Implications**

Authors: Oji, Tatsuo, and Kitazawa, Kota

Source: Zoological Science, 25(1) : 115-121

Published By: Zoological Society of Japan

URL: <https://doi.org/10.2108/zsj.25.115>

---

BioOne Complete ([complete.BioOne.org](https://complete.BioOne.org)) is a full-text database of 200 subscribed and open-access titles in the biological, ecological, and environmental sciences published by nonprofit societies, associations, museums, institutions, and presses.

Your use of this PDF, the BioOne Complete website, and all posted and associated content indicates your acceptance of BioOne's Terms of Use, available at [www.bioone.org/terms-of-use](https://www.bioone.org/terms-of-use).

Usage of BioOne Complete content is strictly limited to personal, educational, and non - commercial use. Commercial inquiries or rights and permissions requests should be directed to the individual publisher as copyright holder.

---

BioOne sees sustainable scholarly publishing as an inherently collaborative enterprise connecting authors, nonprofit publishers, academic institutions, research libraries, and research funders in the common goal of maximizing access to critical research.

# Discovery of Two Rare Species of Stalked Crinoids from Okinawa Trough, Southwestern Japan, and Their Systematic and Biogeographic Implications

Tatsuo Oji\* and Kota Kitazawa

Department of Earth and Planetary Science, The University of Tokyo,  
Hongo, Tokyo 113-0033, Japan

A recent submersible dive on the southern slope of Aguni Knoll, central Okinawa Trough has led to a discovery of two rare species of stalked crinoids, *Proisocrinus ruberrimus* and *Naumachocrinus hawaiiensis*, both of uncertain taxonomic affinity. The specimens of *Proisocrinus ruberrimus*, here termed “Moulin rouge” as a pseudonym due to its conspicuous red color, were collected from depths of approximately 1,800 m and are characterized by a long, slender stalk. The proximal columnals are pentalobate in cross section, with isocrinid-like articular facets; several bear rudimentary cirri. The following columnals lose the cirri and rapidly become almost circular; their facets bear radiating crenulations similar to those of Millericrinida. The characters observed in the proximal stalk indicate that the ‘Moulin Rouge’ (*P. ruberrimus*) belongs to the order Isocrinida rather than to the order Millericrinida. *Naumachocrinus hawaiiensis* was collected at a depth of 1,440 m. The long, cylindrical crown and number of arms indicate that *Naumachocrinus* should be classified in the Bathycrinidae.

**Key words:** crinoid, taxonomy, biogeography, ecology

## INTRODUCTION

The Okinawa Trough is a long, crescent-shaped basin extending for over 1,000 km in a NE-SW direction, with a maximum depth of around 2,000 m. It is bordered to the north by the continental shelf of the East China Sea and to the south by the Okinawa Archipelago. Thus the deep-sea environment of the trough is somewhat isolated from the other deep-sea environments of the Pacific, and it is possible that the fauna of this basin may be relatively isolated from the faunas in the adjacent seas. Because the stalked crinoid fauna of the trough is almost unknown, except for some brief sightings by submersible dives, it has not been clear whether it is similar to that of the rest of the western Pacific or is a distinctly different fauna.

A submersible dive by *Shinkai 6500* was made on the southern slope of Aguni Knoll, central Okinawa Trough, on 18 July 2006. The foot of the knoll lies at approximately 1,800 m depth, and the summit is at approximately 1,240 m. During this dive, two species were collected: *Proisocrinus ruberrimus* from the southern foot of the Knoll (1,804–1,763 m) and *Naumachocrinus hawaiiensis* from further up the southern slope, at 1,440 m. Observations from the slope of Aguni Knoll by submersible revealed frequent exposures of pillow lava and fallen blocks of lava that provide an appropriate anchorage for these crinoids.

*Proisocrinus ruberrimus* Clark is rare in the western

Pacific. It attaches on rocky substrates via an attachment disk, and thus is difficult to collect by trawl or dredge. Though it has been observed from submersibles in waters near Tahiti, Hawaii, and New Caledonia (Roux, 1980, 1994; see also Monterey Bay Research Institute web page at <http://www.mbari.org/expeditions/hawaii/Leg2/April16.htm>), there are only two specimen records (Clark, 1910; Roux, 1980) in addition to the present discovery.

This has been a problematic species from the systematic viewpoint. A single specimen was discovered off the Philippines by the US vessel *Albatross* in 1909. Clark (1910) described this crinoid without assigning it to any particular family or order. Instead, he suggested an affinity with various higher-level groups, such as “Pentacrinidae” (=Isocrinidae, included in Isocrinida), Millericrinida, or Bathycrinidae (Bourgueticrinida). This is because this species appears at least superficially as a “composite,” composed of skeletal parts from different taxa: the crown of a bathycrinid, the proximal stalk of an isocrinid, and the intermediate to distal stalk of a millericrinid. In his later revision of the family Pentacrinidae (=Isocrinidae), Clark (1923) did not include *Proisocrinus*. Rasmussen (1978) placed *P. ruberrimus* in a new, monospecific family, Proisocrinidae, within the order Isocrinida, stressing its affinity with Isocrinidae on the basis of its cirri-bearing nodals in the proximal stalk. However, Roux (1997) proposed that this genus should be included in the order Millericrinida based on the distribution of ambulacra on the disk, and columnal articular facets with radiating rather than the petaloid crenulations typical of isocrinids. Recently, Cohen *et al.* (2004) conducted a molecular phylogenetic analysis of 10 crinoid genera (10 species), including *Proisocrinus*. Although

\* Corresponding author. Phone: +81-3-5841-4506;  
Fax : +81-3-5841-4555;  
E-mail: oji@eps.s.u.tokyo.ac.jp

doi:10.2108/zsj.25.115

molecular data were not available for *Proisocrinus*, these authors suggested from a cladistic analysis of morphological characters that this genus “is weakly attached to the isocrinid clade” (Cohen *et al.*, 2004, p. 605).

*Naumachocrinus hawaiiensis* Clark is a moderate-sized bourgueticrinid with a long, slender crown, and it has strongly twisting columnals with synarthrial articulations in the distal part of the stalk. This species also has a terminal attachment disk. The holotype lacks arms above the first primibrachials, thus missing an important diagnostic part of the crinoid. Clark (1912) included this genus in the family

Phrynocrinidae based on the existence of an attachment disk rather than radicular cirri (which are common in the family Bathyrcrinidae), and by its moderately large size. Clark (1973) included *N. hawaiiensis* in a new family, Porphyrocrinidae, in the order Bourgueticrinida, because of its cylindrical calyx and attachment disk. Rasmussen (1978) maintained this interpretation. However, Amézière-Cominardi (1991) reported occurrences of specimens of *N. hawaiiensis* by French BIOCAL and CALSUB expeditions off New Caledonia. She also mentioned that several specimens of this species were collected with their arms. There

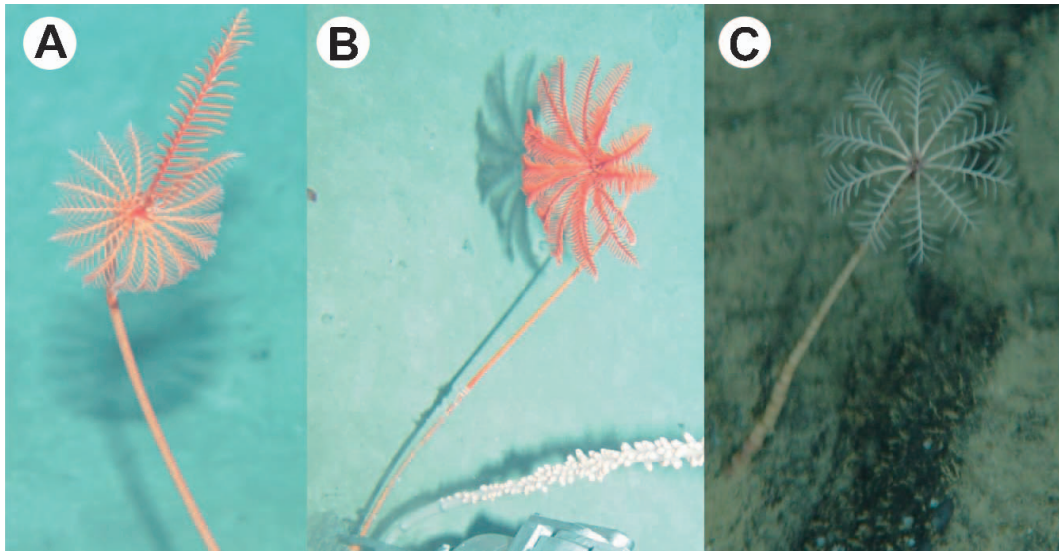

**Fig. 1.** Underwater photographs of stalked crinoids collected from the Okinawa Trough. **(A)** *Proisocrinus ruberrimus*, Specimen 4, 1,804 m. **(B)** *Proisocrinus ruberrimus*, Specimen 1, 1,803 m. **(C)** *Naumachocrinus hawaiiensis*, Specimen 1, 1,440 m.

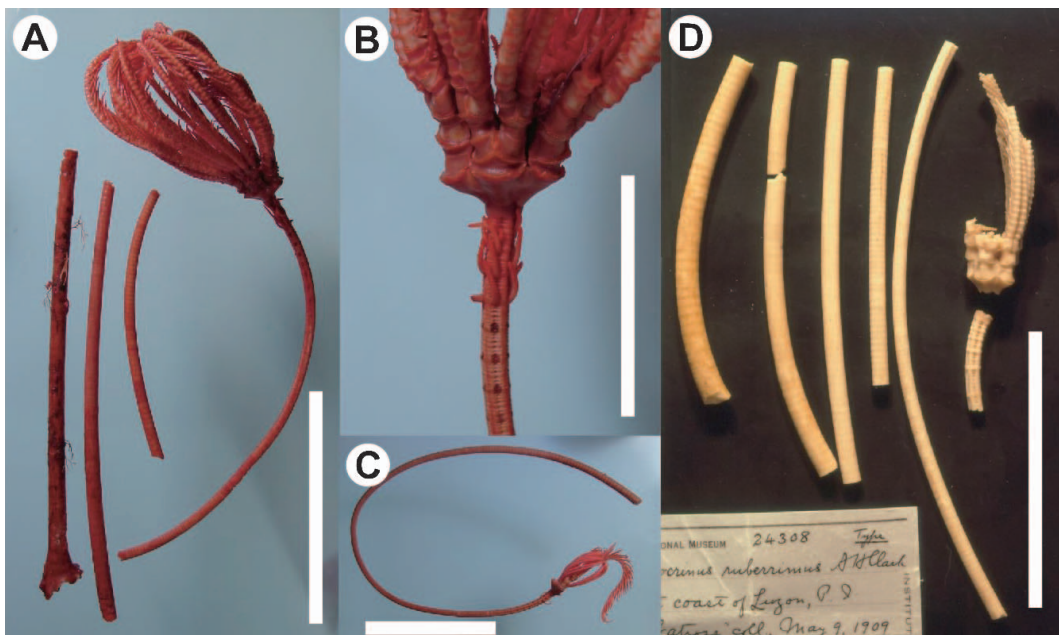

**Fig. 2.** *Proisocrinus ruberrimus*. **(A)** Specimen 4 with complete stalk and crown. Note distal attachment disk. **(B)** Proximal stalk and proximal crown of Specimen 4. Note that the cirri on the proximal nodals disappear distally. **(C)** Specimen 1. **(D)** Holotype. Almost all the arms are regenerated. Scales are 10 cm (A, C, D) and 5 cm (B).

are ten arms, and thus she classified this species in the Bathycrinidae (1991, p. 114). Mironov (2000) also proposed that *Naumachocrinus* should be placed in the Bathycrinidae. The new specimen retains complete arms, a critical taxonomic feature that should help clarify its phylogenetic position.

The purpose of this paper is to provide new morphological data on these two species collected by the recent submersible dive, and to discuss their biogeographical and ecological implications.

## MATERIALS AND METHODS

Five specimens of *Proisocrinus ruberrimus*, collected during *Shinkai 6500* dive No. 961 on 18 July 2006, were examined. Of these, four specimens (1 to 4) were collected from a pillow lava at Locality 1 (27°00.71'N, 126°37.02'E, depth 1,803–1,804 m) (Figs. 1A, B, 2A–C), and one specimen (5) was collected on a fallen block of lava at Locality 2 (27°00.82'N, 126°37.03'E, depth 1,765 m). Both localities are on the southern foot of Aguni Knoll. The holotype (USNM 24308, National Museum of Natural History, Washington D.C.) was also examined. This specimen was collected by the *Albatross* in 1909 off the Philippines (15°58.15'N, 119°40.20'E, depth 1,719 m). Over time it has lost its original color and is now nearly white (Fig. 2D). The original label on this specimen notes, “brilliant uniform scarlet,” typical of the “Moulin Rouge.”

Two specimens of *Naumachocrinus hawaiiensis*, each

anchored by a terminal attachment disk on rocky substrate, were collected from Locality 3 (27°01.27'N, 126°37.10'E, depth 1,440 m) (Fig. 1B).

Three specimens of *P. ruberrimus* and two of *N. hawaiiensis* were kept in 99.5% ethanol for macroscopic observation and for a future phylogenetic molecular analysis. Two specimens of *P. ruberrimus* were kept in 10% formalin diluted with sea water. Part of the stalk of Specimen 3 was disarticulated in diluted Chlorox bleach for a few hours, then washed in tap water and air-dried. The disarticulated columnals were observed and photographed by a binocular microscope (Olympus SZH10) with a digital camera (Olympus DP 70).

All the specimens collected from the Okinawa Trough are in the University Museum, The University of Tokyo, under accession numbers UMUT RE 29474–RE 29478 for *Proisocrinus ruberrimus* and RE 29479 and RE 29480 for *Naumachocrinus hawaiiensis*.

## RESULTS

### Taxonomy

*Proisocrinus ruberrimus* Clark, 1910  
(Figs. 1A, B, 2, 3; Table 1)

Specimens of *P. ruberrimus* are relatively large, with stalk length 65–84.3 cm (except for specimens with incomplete stalks) and crown length 11–17 cm (Table 1). Arm division occurs twice or three times, and the total number of

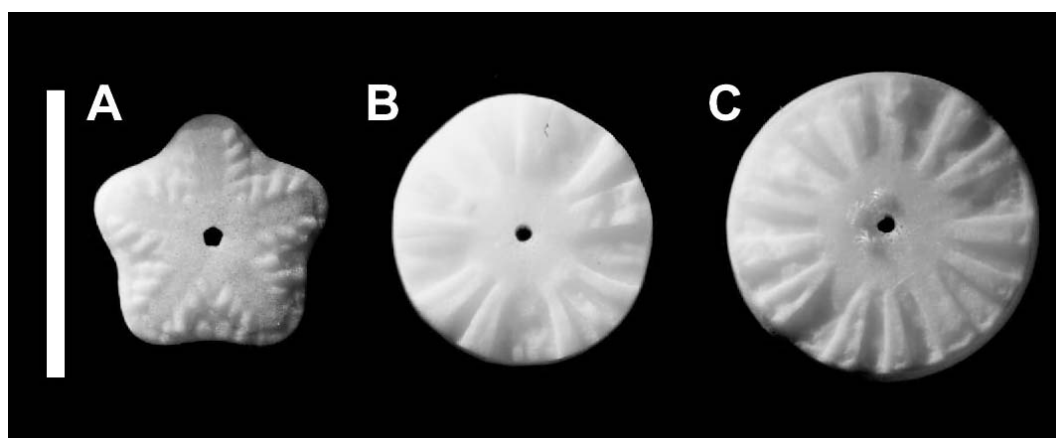

**Fig. 3.** Articular facets of columnals of *Proisocrinus ruberrimus*. All from Specimen 3. **(A)** Columnal from proximal stalk showing its pentalobate outline with five ligamentary fields surrounded by ridges and furrows. **(B)** Columnal from intermediate stalk. Note circular outline, with radiating ridges and furrows. **(C)** Columnal from distal stalk. Scale is 5 mm.

**Table 1.** Size of specimens of *Proisocrinus ruberrimus* from the Okinawa Trough. Stalk length is in centimeters; other stalk measurements are in millimeters. Attachment disks are retained only in Specimens 1 and 3. The most distal stalk diameter of Specimens 1 and 3 represents the diameters of columnals before enlarging toward the attachment disk. Other specimens (\*) lack the most distal part of the stalk due to breakage during sampling, and thus stalk length and diameter were measured to the most distal parts of the remaining stalk. Data on the stalk of the holotype were adopted from Clark (1911).

	stalk length	most proximal stalk diameter	most distal stalk diameter	no. of arms	arm length
No. 1	66.5	5.0	11.0	20	11
No. 2	65	5.3	9.9	15	12.5
No. 3*	48	5.3	6.3	17	14
No. 4*	58	5.0	11.0	20	12
No. 5*	75	5.9	8.0	>14	17
Holotype	84.3	6	9.5	20	15.5

arms ranges from 15 to 20, except for one incomplete specimen (no. 5) in which the original number of arms is unknown.

There are short cirri on the nodals in the proximal part of the stalk (Fig. 2B), as in all isocrinids. The proximal stalk is sub-rounded pentagonal in outline and consists of short columnals. Nodals are slightly thicker than internodals. There are gradual insertions of internodals toward the distal stalk, and the number of internodals per noditaxis increases from one to more than 30. The cirri become gradually shortened, and no cirri are observed in the intermediate to distal part of the stalk. In the intermediate to distal stalk, the distinction of nodals from internodals becomes blurred and thus unclear, leaving almost no trace of a cirrus scar, with an almost uniform thickness of columnals. There is a gradual increase in stalk diameter distally, from 5–7 mm to 9–10 mm, and the outline of columnals also changes distally, from sub-rounded pentagonal to perfectly circular (Fig. 3). The articulation between columnals also changes from a pentaradial to a circular pattern with peripheral crenulation. Specimens 1 and 2 retain the distalmost parts of the stalk, with attachment disks for anchorage.

The basals are high and contiguous. The radials are directed outward, forming a wide, conical cup. The primibrachials are united by ligamentary articulations with a flat outer surface, presumably by synostosis. There are also similar ligamentary articulations in the secundibrachials (mostly in IIBr1+2) and tertibrachials (IIIBr1+2). There are almost no

further ligamentary articulations in the more distal arms. The details of arm branching and the position of ligamentary articulations are shown in Appendix 1.

Of the five specimens, four specimens have at least one regenerating arm. Almost all the arms of Specimen 4 were regenerated from the base of tertibrachials (third branching series), and Specimen 5 has only half of its arms intact; the other half are broken or missing from the proximal arm, with broken edges.

*Naumachocrinus hawaiiensis* Clark, 1912

(Figs. 1C, 4)

By observation from the submersible, this species appears to occur at depths of around 1,500 m.

Specimen 1 has the crown and most of the stalk, but lacks the distalmost stalk. Specimen 2 is abnormal, consisting only of a stalk and overgrown section of pluricolumnals (Fig. 4). This specimen also lacks the distalmost stalk.

The length of stalk remaining in Specimen 1 is 223 mm, and that in Specimen 2 is 271 mm. The stalk is 2.2 mm in diameter in Specimen 1 and 2.7 mm in Specimen 2, and gradually increases distally. Columnals just below the crown are very low, but become rapidly elongated and cylindrical and occupy more than two-thirds of the total length of the stalk. The distal part of the stalk consists of about 11 columnals in Specimen 1 and about 14 columnals in Specimen 2, united by typical synarthries that produce a zigzag outline

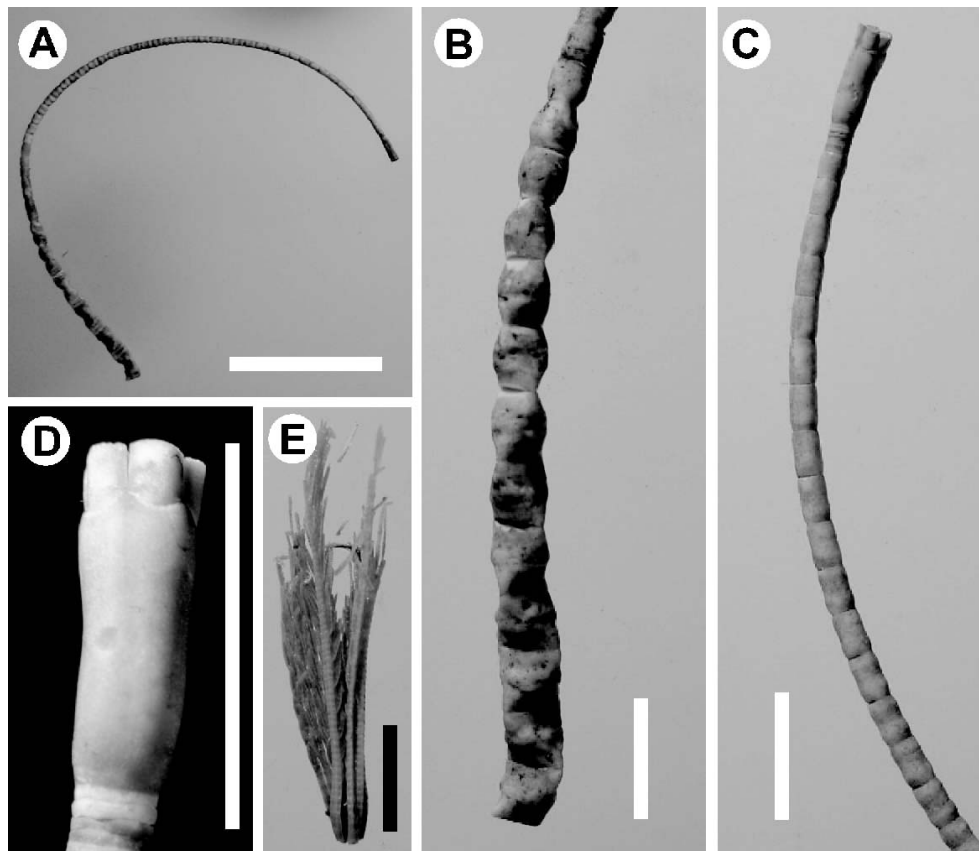

**Fig. 4.** *Naumachocrinus hawaiiensis*. (A) Specimen 1. (B) Distal stalk with synarthrial articulations. (C) Proximal stalk and crown (long, almost fused basals with short radials). (D) Enlarged view of crown. (E) Arms. Scales are 5 cm (A), and 1 cm (B–E).

with twisting articulations. The distal stalk is oval in cross section, with the major and minor diameters 6.2 mm by 3.2 mm in Specimen 1 and 5.9 mm by 5.2 mm in Specimen 2.

The crown is present only in Specimen 1 (Figs. 4D, E). The theca (basals and radials) is 7.9 mm long and 2.6 mm wide. Infrabasals were not confirmed. The five basals are 6.2 mm high but are almost fused to each other. The radials are low, 1.7 mm high. The arms are fragile, 40.0 mm long, with short brachials and relatively long pinnules. There are two primibrachials, and the second primibrachial is the first axillary. Primibrachials are low and separated (not contiguous). There is no further division of arms, and the number of arms is 10.

The proximal stalk of Specimen 2 tapers distally, with irregularly shaped columnals. We interpret this as an example of an overgrowth, that is, abnormal regeneration after breakage (Oji and Amemiya, 1998), probably due to "decapitation" of the crown and the proximal stalk by sublethal predation. Similar overgrowth has been reported from *Democrinus* (Donovan and Pawson, 1998).

## DISCUSSION

This new discovery of two rare species of stalked crinoids has two important implications, firstly for the taxonomic status of the two species based on the new morphological information, and secondly for an improved understanding of their biogeography and ecology.

### Taxonomy

The existence of cirri in the proximal stalk of *Proisocrinus ruberrimus*, as well as the pentalobate outline of the columnals with five lanceolate ligamentary fields surrounded by crenulae, strongly suggests that this species should be included in the order Isocrinida rather than in the order Millericrinida. The articulation between the proximal columnals is illustrated for the first time (Fig. 5A). The cirri suggest that *P. ruberrimus* can be regarded as descended from a species of Isocrinidae. The cirri of *P. ruberrimus* are very short, and toward the distal stalk become shortened and obscured from external view, and finally disappear completely. Therefore, we regard the cirri of this species as rudimentary.

In Isocrinidae, the function of the cirri is for anchorage. However, the cirri do not function for anchorage at first. New columnals, including cirrus-bearing nodals, develop in the proximal part of the stalk. As the stalk grows, and older columnals are "pushed" distally, the cirri mature and finally start to function in anchoring the whole body by grasping a hard substrate with their terminal claws. All isocrinids appear to autotomize their distal stalk with growth, so that adult specimens do not retain the original juvenile stalk. *Proisocrinus ruberrimus* abandoned anchorage by cirri and instead retained the attachment disk, characteristic of other stalked crinoids as well as juvenile isocrinids. Therefore, the species probably does not exhibit the continuous stalk growth characteristic of most isocrinids. We regard *P. ruberrimus* as having derived from some isocrinid species by changing the mode of growth of the stalk and cirri.

We interpret the radiating crenulations on the articular facets of intermediate to distal columnals as the result of secondary secretion of calcite around the original, isocrinid-

like columnals, modifying the columnals into a totally different type similar to that of the Millericrinida.

The articulation between the primibrachials of *P. ruberrimus* by synostosis suggests that this species is probably derived from the group of Isocrinidae with cryptosyzygial or synostosal articulation in the primibrachials, rather than from the group with synarthrial articulations. Most isocrinids with cryptosyzygial/synostosal articulations in the primibrachials have originated since the Early Cretaceous (Rasmussen, 1978; Oji, 1985). Thus, the close resemblance of this species to some Jurassic millericrinids (Roux, 1980) is likely superficial and a result of convergence.

*Naumachocrinus hawaiiensis* is characterized by a cylindrical calyx, ten arms, synarthrial articulations in the mid- to distal stalk, and an attachment disk. Opinions differ about subdivisions of the Bourgueticrinida (i.e., Mironov, 2000; Roux et al., 2003), but if we follow the subdivision by Rasmussen (1978), this large group contains four extant families (Bathycrinidae, Phrynocrinidae, Zeuctocrinidae, and Porphyrocrinidae) that all have some characteristics in common with *Naumachocrinus*.

Some bathycrinids, such as *Democrinus*, *Conocrinus*, and *Monachocrinus*, have an elongated calyx similar to that of *Naumachocrinus*. However, the calyces of the former three genera consist of elongated basals and low radials, whereas the calyx of *Naumachocrinus* consists of very low basals and elongated radials. Thus the similar elongated morphology of the calyx may be a superficial resemblance.

The detailed characteristics of the arms of *Naumachocrinus hawaiiensis* are apparent for the first time. This species has ten arms, as observed in *Democrinus*, *Conocrinus* and *Monachocrinus* (Bathycrinidae), as opposed to species within the Phrynocrinidae and Zeuctocrinidae, which usually possess more than ten arms. However, like the members of the latter two families, *N. hawaiiensis* has an attachment disk, whereas bathycrinids characteristically have radicular cirri.

Taking the characters outlined above into consideration, it is difficult to assign *Naumachocrinus* to the Bathycrinidae, Phrynocrinidae, or Zeuctocrinidae. However, if a combination of evolutionary remodeling of calyx plate morphology was coupled with paedomorphic retention of the juvenile attachment disk until the adult stage, it could reduce the taxonomic importance of the shape of calyx or the attachment disk in classification. This study suggests that the number of arms seems of primary importance in this group. Thus, based on the evidence above, as suggested by Ameziane-Cominardi (1991) and Mironov (2000), we think that *Naumachocrinus* is better placed in the family Bathycrinidae than in the family Phrynocrinidae.

### Biogeography

The two species reported here have been very rarely reported from the Pacific, although both species must be widely distributed in the Pacific. Up to now, *P. ruberrimus* has been collected or observed widely in the western and central Pacific, including from the Philippines, Tahiti, Hawaii, and the Okinawa Trough. Such disjunct records could be explained by the habitat restriction of this species to rocky substrates, where trawling or dredging is quite difficult. The records of *N. hawaiiensis* from Hawaii, Okinawa, and New

Caledonia suggest that this species is more widely distributed than previously thought, though its small size and occurrence on rocky substrates make it difficult to collect.

In conclusion, the two species are not endemic to the Okinawa Trough. It is far more probable that they are pan-demic in the west Pacific. Further research could clarify their true extent and ecological zonation across the Pacific region.

### Ecology

The high frequency of regenerating arms in the both species from the Okinawa Trough suggests that they are subjected to frequent non-lethal predation. Although the predators are unknown, this has proved a surprising observation in such a deep environment. This is the first discovery of such predation in deep-water crinoids similar to that observed in shallow-water crinoids, and is somewhat contradictory to the previous notion that stalked crinoids are subject to lower predation pressure in deep water. For instance, in the Bahamas and Caribbean, individuals of the isocrinid *Endoxocrinus parrae* collected from depths <500 m have more numerous regenerated arms than those from depths >500 m (Oji, 1996). Within the Okinawa Trough, stronger predation is expected at depths even greater than 1,500 m, if compared with the case in the western Atlantic. Messing (2007) described the stalked crinoid *Porphyrocrinus verrucosus* (Porphyrocrinidae) from Palau and reported that two of the three specimens have regenerating crowns. He attributed the cause of regeneration to sublethal predation or to environmental disturbances such as turbulent flow.

Aside from sublethal predation, a possible factor that may induce arm damage and subsequent arm regeneration is environmental disturbance, such as turbidity currents. However, the frequency of such disturbance must be quite low, in comparison with the time required for the growth of crinoids. There are many regenerating arms at different growth stages in individuals among the collected samples, and some individuals have many regenerated arms, whereas one specimen does not have any regeneration. If these patterns of occurrence of regenerated arms are taken into account, it is difficult to attribute the cause of damage to environmental disturbances.

### ACKNOWLEDGMENTS

We thank the crew members of Shinkai dive No. 961 and the R/V *Yokosuka* cruise No. YK-0609 conducted by JAMSTEC for their help in carrying out the dive. We also thank Dave Pawson and Cindy Ahearn for allowing us to examine the holotype of *Proisocrinus ruberrimus* kept in the U.S. National Museum of Natural History, Smithsonian Institution. We thank Aaron Hunter for reading the manuscript and improving the English text. Alexander Mironov kindly sent us the English abstract of his paper. The nickname

“Moulin rouge” for *Proisocrinus ruberrimus* was provided by Ichizo Kogo, to whom we are very grateful for his colorful imagination. Two anonymous reviewers greatly improved the English of the manuscript, and also gave us many valuable comments.

### REFERENCES

- Améziane-Cominardi N (1991) Distribution bathymétrique des pentacrines du Pacifique occidental. *Docum Lab Geol Lyon* 116: 1–253
- Clark AH (1910) *Proisocrinus*, a new genus of the Recent crinoids. *Proc US Natl Mus* 38: 387–390
- Clark AH (1912) *Naumachocrinus*, a new genus belonging to the crinoid family Phrynocrinidae. *Proc US Natl Mus* 42: 195–197
- Clark AH (1923) A revision of the recent representatives of the crinoid family Pentacrinidae, with the diagnoses of two new genera. *J Wash Acad Sci* 13: 8–12
- Clark AM (1973) Some new taxa of Recent stalked crinoids. *Bull Brit Mus (Nat Hist) Zool* 25: 265–288
- Cohen BL, Améziane N, Eléaume M, De Forges BR (2004) Crinoid phylogeny: a preliminary analysis (Echinodermata: Crinoidea). *Mar Biol* 144: 605–617
- Donovan SK, DL Pawson (1998) Proximal growth of the column in bathytrid crinoids (Echinodermata) following decapitation. *Bull Mar Sci* 61: 571–579
- Messing CG (2007) The crinoid fauna (Echinodermata: Crinoidea) of Palau. *Pac Sci* 61: 91–111
- Mironov AN (2000) New taxa of stalked crinoids from the suborder Bourgueticrinina (Echinodermata, Crinoidea). *Zool Zhur* 79: 712–728 (in Russian)
- Oji T (1985) Early Cretaceous *Isocrinus* from Northeast Japan. *Palaeontology* 28: 661–674
- Oji T (1996) Is predation intensity reduced with increasing depth? Evidence from the west Atlantic stalked crinoid *Endoxocrinus parrae* (Gervais) and implications for the Mesozoic marine revolution. *Paleobiology* 22: 339–351
- Oji T, Amemiya S (1998) Survival of crinoid stalk fragments and its taphonomic implications: additional discussion. *Paleontol Res* 2: 285–286
- Rasmussen HW (1978) Articulata. In “Treatise on Invertebrate Paleontology, pt T (Echinodermata 2)” Ed by RC Moore, C Teichert, Geological Society of America and University of Kansas, Boulder, pp T813–T928
- Roux M (1980) Découverte de sites à Crinoïdes pédonculés (genre *Diplocrinus* et *Proisocrinus*) au large de Tahiti. *C R Acad Sci D* 290: 119
- Roux M (1994) The CALSUB cruise on the bathyal slopes off New Caledonia. *Mém Mus Nat d’Hist Nat* 21: 319–327
- Roux M (1997) Classification et ontogenèse chez les crinoïdes: une révision nécessaire de la hiérarchie des caractères. *Bull Soc Zool France* 122: 371–378
- Roux M, Messing CG, Améziane N (2002) Artificial keys to the genera of living stalked crinoids (Echinodermata). *Bull Mar Sci* 70: 799–830

(Received May 29, 2007 / Accepted September 12, 2007)

**Appendix 1.** Diagram of arm divisions and occurrence of synostosal articulations in the five specimens of *Proisocrinus ruberrimus*. R, radials; +, synostosis; -, muscular articulation. For example, each of the specimens has five radials (R), followed usually by two brachials, which are usually united by synostosis. A number *n* at the arm termination indicates that the brachitaxis (branching series) terminates at the *n*<sup>th</sup> brachial; no number at the arm termination indicates that the arm gradually tapers distally, with numerous tiny brachials. Rectangles indicate regenerating parts of arms.

No. 1.

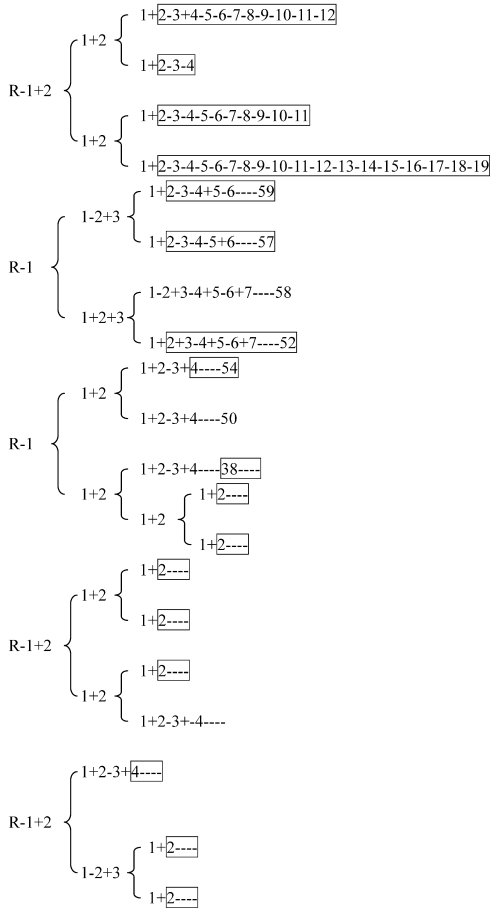

No. 2.

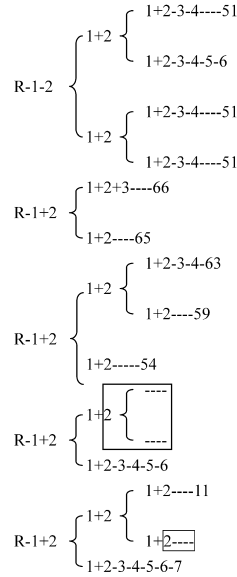

No. 3.

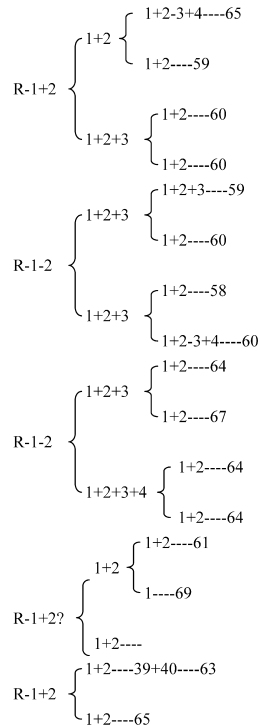

No. 4.

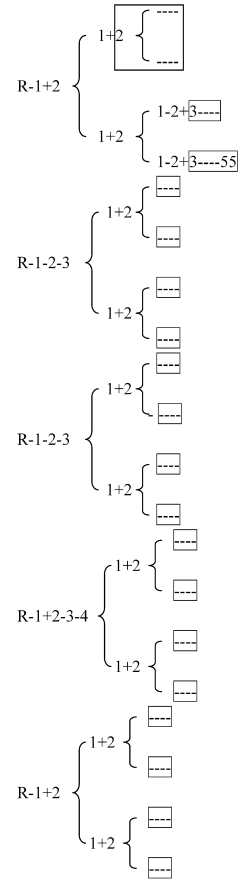

No. 5.

