



New Data on the Jumping Spiders of South Africa (Araneae: Salticidae)

Authors: Wesołowska, Wanda, and Haddad, Charles R.

Source: African Invertebrates, 54(1) : 177-240

Published By: KwaZulu-Natal Museum

URL: <https://doi.org/10.5733/afin.054.0111>

BioOne Complete (complete.BioOne.org) is a full-text database of 200 subscribed and open-access titles in the biological, ecological, and environmental sciences published by nonprofit societies, associations, museums, institutions, and presses.

Your use of this PDF, the BioOne Complete website, and all posted and associated content indicates your acceptance of BioOne's Terms of Use, available at www.bioone.org/terms-of-use.

Usage of BioOne Complete content is strictly limited to personal, educational, and non - commercial use. Commercial inquiries or rights and permissions requests should be directed to the individual publisher as copyright holder.

BioOne sees sustainable scholarly publishing as an inherently collaborative enterprise connecting authors, nonprofit publishers, academic institutions, research libraries, and research funders in the common goal of maximizing access to critical research.

New data on the jumping spiders of South Africa (Araneae: Salticidae)

Wanda Wesolowska¹ and Charles R. Haddad^{2*}

¹Department of Biodiversity and Evolutionary Taxonomy, Wrocław University, Przybyszewskiego 63/77, PL 51-148 Wrocław, Poland; tomwes@biol.uni.wroc.pl

²Department of Zoology & Entomology, University of the Free State, P.O. Box 339, Bloemfontein, 9300 South Africa; haddadcr@ufs.ac.za

* Corresponding author

ABSTRACT

Examination of museum collections and of recently collected materials lead to the discovery of the following 19 jumping spider species that are described here: *Asemonea amatola* sp. n. (♀), *A. clara* sp. n. (♀), *Belippo meridionalis* sp. n. (♂♀), *Colaxes benjamini* sp. n. (♂♀), *Dendryphantès limpopo* sp. n. (♀), *D. silvestris* sp. n. (♂♀), *Evarcha denticulata* sp. n. (♂), *Heliophanus gramineus* sp. n. (♀), *H. ndumoensis* sp. n. (♂), *Langelurillus krugeri* sp. n. (♀), *Massagris contortuplicata* sp. n. (♀), *Pseudicius dentatus* sp. n. (♂♀), *P. femineus* sp. n. (♀), *P. flabellus* sp. n. (♂), *P. imitator* sp. n. (♂♀), *Rhene amanzi* sp. n. (♂), *R. punctatus* sp. n. (♂), *R. timidus* sp. n. (♀), and *Tomomingi szutsi* sp. n. (♂♀). A new genus, *Ureta* gen. n., is described, with *U. quadrispinosa* (Lawrence, 1938) comb. n. (from *Euophrys* C.L. Koch, 1834) as the type species. Two further new combinations are proposed: *Afromarengo bimaculata* (Peckham & Peckham, 1903) comb. n., transferred from *Copocrossa* Simon, 1901, and *Brancus mustelus* (Simon, 1902) comb. n., transferred from *Evarcha* Simon, 1902. *Massagris regina* Wesolowska, 1993 is synonymised with *M. honesta* Wesolowska, 1993. The unknown adults of *A. bimaculata*, the unknown males of *Heliophanus aberdarensis* Wesolowska, 1986, *Pseudicius africanus* Peckham & Peckham, 1903 and *U. quadrispinosa*, and the unknown females of *Evarcha striolata* Wesolowska & Haddad, 2009, *Rhene facilis* Wesolowska & Russell-Smith, 2000 and *Sibianor victoriae* Logunov, 2000, are described. Twelve species are recorded from South Africa for the first time: *Asemonea murphyae* Wanless, 1980, *Dendryphantès rafalskii* Wesolowska, 1999, *Evarcha zimbabwensis* Wesolowska & Cumming, 2008, *Hasarius adansoni* (Audouin, 1826), *Heliophanus aberdarensis*, *H. pygmaeus* Wesolowska & Russell-Smith, 2000, *Langona tortuosa* Wesolowska, 2011, *Mogrus mathisi* (Berland & Millot, 1941), *P. elegans* Wesolowska & Cumming, 2008, *R. facilis* Wesolowska & Russell-Smith, 2000, *S. victoriae* and *Xuriella prima* Wesolowska & Russell-Smith, 2000. Additionally, new provincial records for species previously recorded from elsewhere in South Africa are provided for the Eastern Cape (eight spp.), Western Cape (five spp.), Limpopo (two spp.), and North West and Mpumalanga provinces (one species from each).

KEY WORDS: Afrotropical, Araneae, Salticidae, jumping spiders, taxonomy, new synonym, new combinations, new taxa, new records, canopy fogging.

INTRODUCTION

The first stages of the taxonomic exploration of southern African jumping spiders (Salticidae) began during the late 19th and early 20th centuries through significant contributions by Simon (1887, 1902, 1910) and Peckham & Peckham (1902, 1903). Studies were continued by Lessert (1925, 1936) and Lawrence (1928, 1937, 1938, 1942, 1947). Together, these authors described several tens of salticid species and provided some baseline data on their distribution. This and other taxonomic information was later included into a first catalogue of the jumping spiders of southern Africa (Cutler 1976).

Studies of southern African jumping spiders have intensified during the last five years through the publication of several large taxonomic and faunistic papers (e.g. Wesolowska 2006, 2011; Wesolowska & Cumming 2008, 2011; Wesolowska & Haddad 2009; Azarkina & Logunov 2010; Haddad & Wesolowska 2011). Although these papers have made a considerable contribution in redescribing and illustrating many poorly known

<http://www.africaninvertebrates.org.za>

urn:lsid:zoobank.org:pub:E42E487F-D847-4432-99AD-16DC1FE99C6E

species for the first time, and describing a multitude of new species, large areas of the region remain very poorly explored and our knowledge of the family in this part of Africa is still rudimentary.

The present contribution builds on the aforementioned studies through the description of 19 new species and a new genus of jumping spiders from South Africa, descriptions of six hitherto unknown sexes, as well as providing new distribution data for a number of poorly known South African and Afrotropical species, 12 of which are recorded for the first time in South Africa. This study is based mainly on newly collected material, which is supplemented by specimens deposited in museum collections.

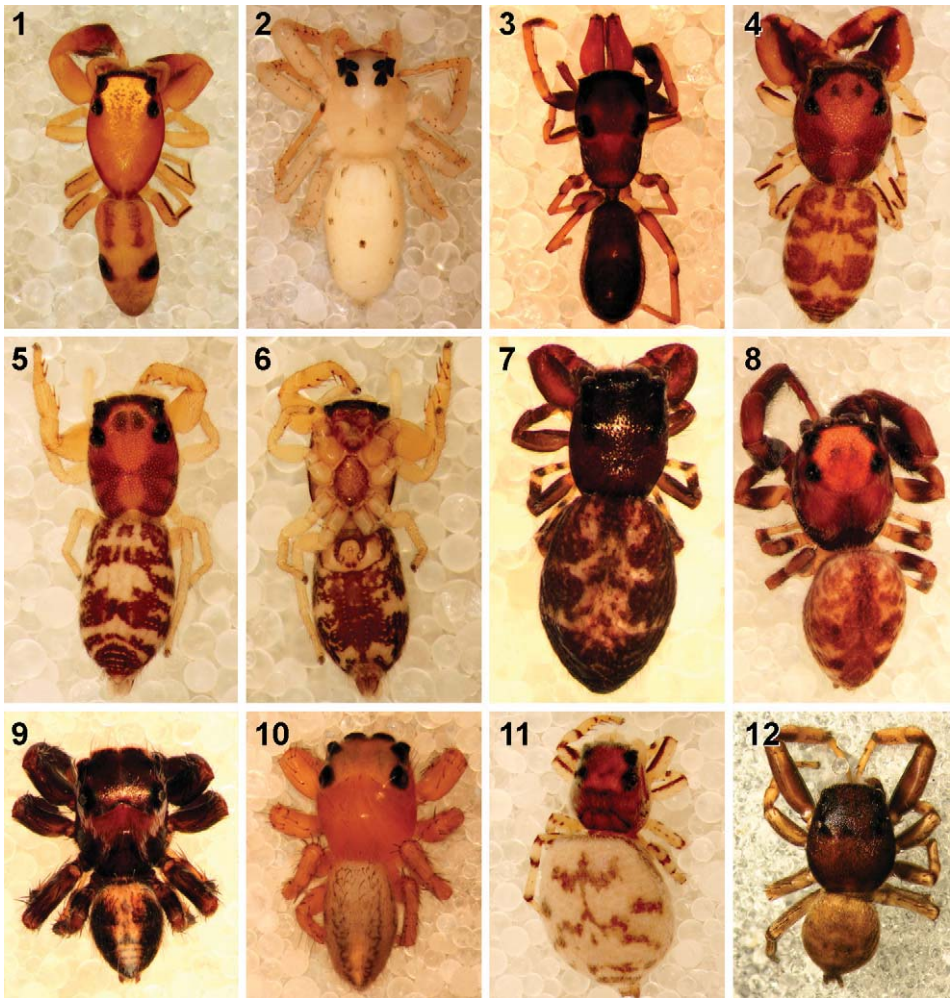

Figs 1–12. Digital microscope photographs of the dorsal habitus (1–5, 7–12) and ventral view (6) of South African jumping spiders: (1) *Afromarengo bimaculata*, ♂; (2) *Asemonaea amatola* sp. n., ♀; (3) *Belippo meridionalis* sp. n., ♂; (4–6) *Colaxes benjamini* sp. n., ♂ (4) and ♀ (5, 6); (7) *Dendryphantes limpopo* sp. n., ♀; (8) *D. silvestris* sp. n., ♂; (9) *Evarcha denticulata* sp. n., ♂; (10) *E. striolata*, ♀; (11) *Heliophamus gramineus* sp. n., ♀; (12) *H. ndumoensis* sp. n., ♂.

The discovery of so many undescribed species is largely the result of using a previously rarely applied collecting technique in the subcontinent, namely canopy fogging. Although Moran and Southwood (1982) conducted a canopy fogging survey from six tree species each in South Africa (Grahamstown and Hogsback) and Great Britain, the whereabouts of the spider material collected from their survey in South Africa are unclear. Since six new species are described here from canopy samples recently collected at Hogsback, it is likely that most of the species collected by Moran and Southwood (1982) would have been collected in these recent samples too. Considering the wealth of new species described in the current paper, this study can be used as an indicator of the multitude of species living in this very poorly explored and inaccessible habitat, which should be the focus of more intensive studies in the future.

MATERIAL AND METHODS

The bulk of the material on which this study is based was collected during the past five years as part of student excursions and research field trips covering a broad geographical range in South Africa. As such, all nine provinces are represented in the material under study, although only four records originate from the Northern Cape, Gauteng and North West provinces, all from museum collections. The majority of records originate from the Eastern Cape and KwaZulu-Natal provinces. Although a sizable portion of the records has been collected using fairly standard techniques (beating, sweep-netting, hand collecting *etc.*), the bulk of the material originates from canopy fogging samples. This method was used at several sites in central, eastern and northern South Africa,

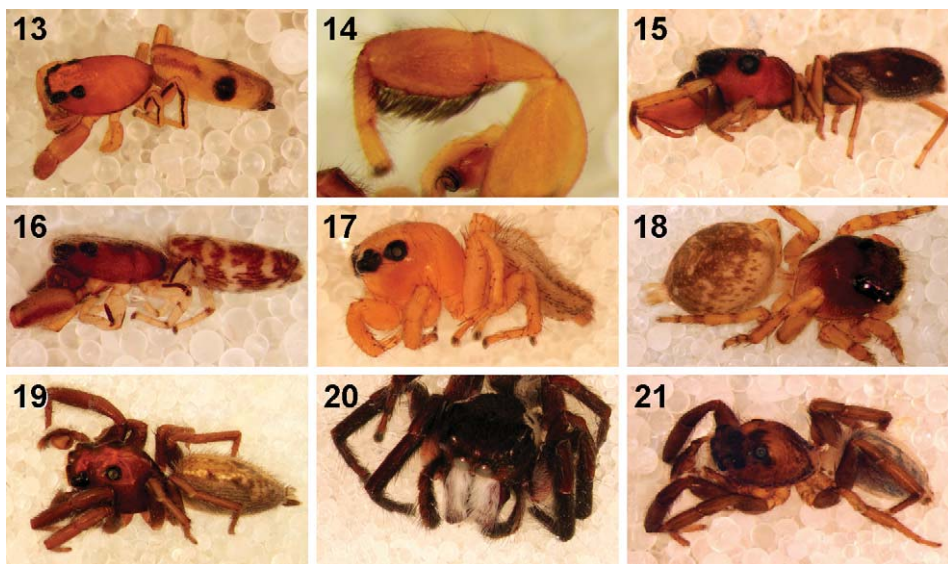

Figs 13–21. Digital microscope photographs of the lateral view (13, 15–19, 21), leg I (14) and antero-dorsal view (20) of South African jumping spiders: (13, 14) *Afromarengo bimaculata*, ♂; (15) *Belippo meridionalis* sp. n., ♂; (16) *Colaxes benjamini* sp. n., ♂; (17) *Evarcha striolata*, ♀; (18) *Habrocestum africanum*, ♀; (19) *Massagris honesta*, ♂; (20) *Mogrus mathisi*, ♂; (21) *Tomomingi szutsi* sp. n., ♂.

and although only a few samples could be taken from most localities, many interesting spider species were discovered.

Spiders examined in this study were preserved in 70% ethanol and examined in a dish with ethanol. Descriptions of colours pertain to wet specimens. Male pedipalps and female epigynes were dissected from some of the specimens for more detailed examination. Where necessary, epigynes were macerated in 5% hot KOH for a few minutes, dehydrated in 100% ethanol, cleared in xylene, and drawn in temporary mounts in eugenol. Following examination, the genitalia were placed in microvials with ethanol and added to the vials containing the specimens from which they had been excised. All measurements and scale bars are given in millimetres and were made with a Nikon binocular microscope equipped with an eyepiece micrometer. Descriptive terminology is standard for spiders.

Digital photographs were taken of the dorsal, ventral, lateral and anterior views of selected species treated in this study using a Nikon Coolpix 8400 mounted on a Nikon SMZ800 stereomicroscope. The images were then stacked using the Combine ZM software (<http://www.hadleyweb.pwp.blueyonder.co.uk>) to increase depth of field.

Distribution maps were prepared using the online mapping software SimpleMapp (Shorthouse 2010). In producing maps of the distribution of each species in South Africa, we included both records presented in the current study, as well as published records in the case of described species.

Types and voucher specimens have been deposited in the following collections (curators given in parenthesis):

- MCZ – Museum of Comparative Zoology, Harvard, USA (Laura Leibesperger);
- MRAC – Royal Museum for Central Africa, Tervuren, Belgium (Rudy Jocqué);
- NCA – National Collection of Arachnida, ARC–Plant Protection Research Institute, Pretoria, South Africa (Ansie Dippenaar-Schoeman);
- BMNH – Natural History Museum, London, UK (Janet Beccaloni);
- NMBA – National Museum, Bloemfontein, South Africa (Leon Lotz);
- NMSA – KwaZulu-Natal Museum, Pietermaritzburg, South Africa (Audrey Ndaba);
- TMSA – Ditsong National Museum of Natural History, Pretoria, South Africa (Robin Lyle).

TAXONOMY

Genus *Afromarengo* Benjamin, 2004

Afromarengo bimaculata (Peckham & Peckham, 1903), **comb. n.**

Figs 1, 13, 14, 22–29

Copocrossa bimaculata: Peckham & Peckham 1903: 187, pl. 19, fig. 7.

Redescription:

Measurements (♂/♀). Cephalothorax: length 1.6–1.7/1.8–2.0, width 1.0–1.1/1.0–1.1, height 0.4–0.5/0.3–0.4. Abdomen: length 2.0–2.2/2.4–2.9, width 0.7–0.8/1.2–1.3. Eye field: length 0.6/0.6–0.7, anterior width 0.7–0.8/0.9, posterior width 0.8–0.9/1.0.

Male.

General appearance as in Fig. 1. Small, elongate spider with strongly flattened body (Fig. 13). Carapace orange to light brownish, with black line along lateral carapace margins; eyes surrounded by black rings, eye field short (occupying about one-third of

carapace length); fovea absent. Clypeus extremely low. Chelicerae with two promarginal and three retromarginal teeth, all teeth very small. Labium and endites orange, sternum elongate, pale. Abdomen long and narrow, brownish grey, with broad median greyish belt. Two large round black patches placed on darker lateral areas, behind midpoint of

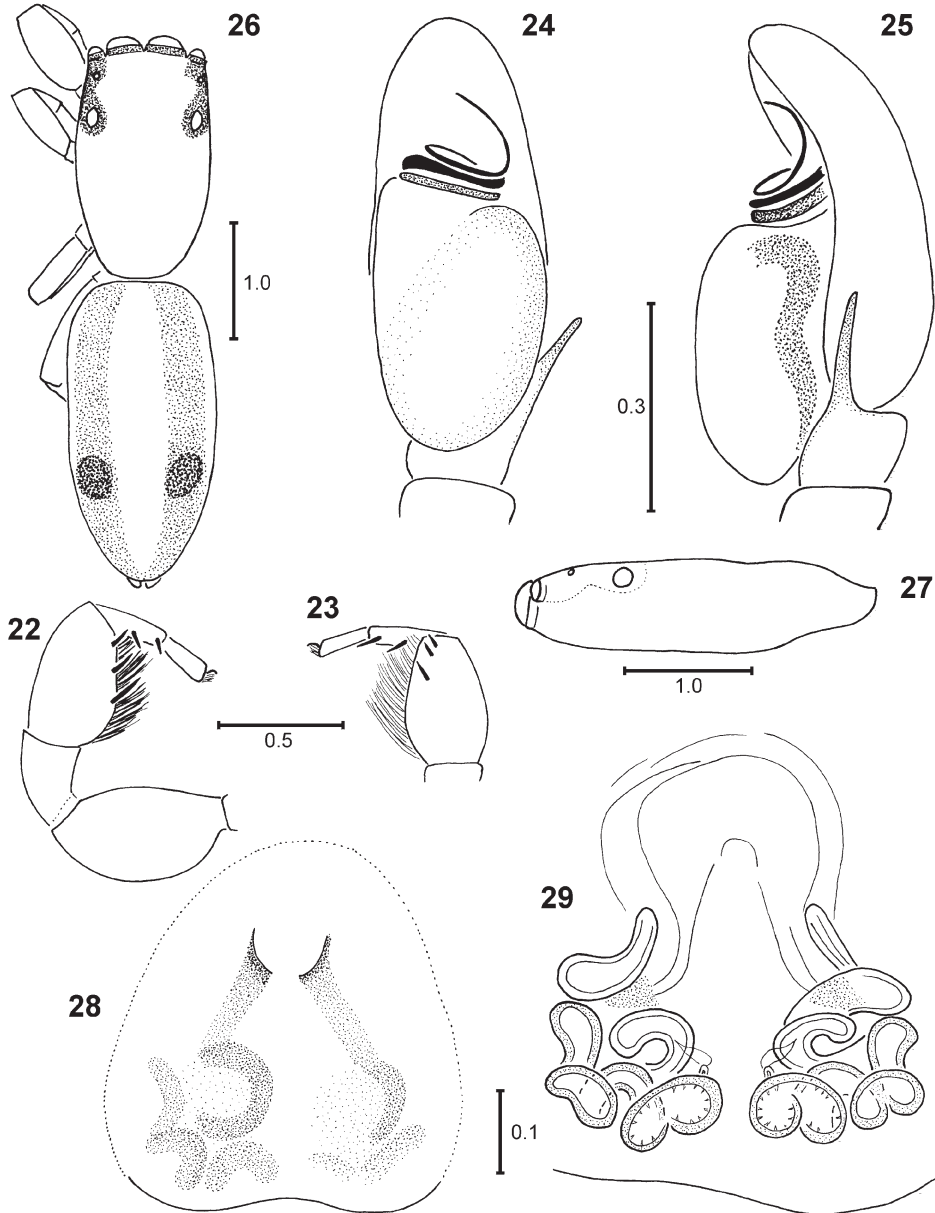

Figs 22–29. *Afromarengo bimaculata*, ♂ (22–25) and ♀ (26–29): (22) first leg, retrolateral view; (23) same, prolateral view; (24) palpal organ, ventral view; (25) same, lateral view; (26) habitus; (27) carapace, lateral view; (28) epigyne, ventral view; (29) internal structure of epigyne.

abdomen (Fig. 1). Venter of abdomen pale brown. Spinnerets black. Legs relatively short in comparison to body length, delicate, light yellow, with delicate dark lines along lateral surfaces of femora, patellae and tibiae III and IV (darker on retrolateral sides). First pair of legs stout, with enlarged femora and swollen tibiae, ventral surface of tibiae clothed in very long, dense, black hairs (Figs 14, 22, 23); three pairs of spines on tibiae I and two pairs on metatarsi I. Pedipalps pale yellow; tibial apophysis thin, bulb oval, slightly elongate, with embolic spiral composed of three loops (Figs 24, 25).

Female.

Similar to male, general appearance as in Fig. 26. Carapace dorsoventrally flattened (Fig. 27). Silver patches of translucent guanine crystals on centre of eye field. Abdominal pattern as in male but colouration slightly lighter. Shape of first leg as in male, but hairs on tibial ventral surface absent. Epigyne weakly sclerotized (Fig. 28); internal structure as in Fig. 29, inlet part of seminal ducts weakly sclerotized (visible after staining with chlorazol black).

Holotype (examined): 1 imm. SOUTH AFRICA: *KwaZulu-Natal*: Durban [29°55'S 30°56'E], Quekett (MCZ).

Other material examined: SOUTH AFRICA: *Eastern Cape*: 2♀ Somerset East, Bestershoek Nature Reserve, 32°42.500'S 25°33.652'E, 810 m, canopy fogging, woodland trees, 3.xii.2011, J. Neethling & C. Luwes (NCA, 2012/1823); 1♀ same data (MRAC). *KwaZulu-Natal*: 6 imm. 1♂ Ophathe Game Reserve, 28°23.202'S 31°24.077'E, 505 m, rocky mountainside, beating short shrubs, 1.x.2008, C. Haddad (NCA, 2008/3975); 7 imm. 1♂ same data (NCA, 2008/3998); 2 imm. 1♂ same locality, 28°22.135'S 31°23.363'E, 560 m, overgrazed savanna, beating short shrubs, 3.x.2008, C. Haddad (NCA, 2008/4141). *Limpopo*: 1♀ Naboomspruit/Mookgopong, Rhemardo Holiday Resort, 24°26.864'S 28°36.705'E, 1295 m, canopy fogging, *Ziziphus mucronata*, 1.ii.2011, C. Haddad, V. Butler & J. Neethling (NCA, 2012/1820). *North West*: 1♀ Rustenburg Nature Reserve, 25°42'S 27°18'E, sweeping, 7.xi.1980, M. Stiller (NCA, 94/100).

Distribution: Species known from scattered localities in South Africa (Fig. 35); recorded for the first time from the Eastern Cape, Limpopo and North West provinces.

Habitat and biology: This foliage-dwelling species lives in tree canopies but has also been collected on lower vegetation, including short broad-leaved shrubs. The majority of localities are from the Savanna Biome.

Remarks: The type specimen is immature, but the characteristic shape of the body and abdominal pattern of this species (presence of two large black patches) is distinctive. The original inclusion of this species into the genus *Copocrossa* Simon, 1901 was probably based on the general body proportions, and these similarities appear to be the result of convergence rather than of generic relationships. *Copocrossa* is a small genus with three species distributed in Australia and the Malay Archipelago, with a fourth species described from Kenya (Platnick 2012). The morphological features of this South African species, especially the shape of the first leg and the structure of the genitalia, are typical for *Afromarengo* Benjamin, 2004. The placement of the Kenyan species, *C. albozonata* Caporiacco, 1949, should be clarified as it too may be misplaced.

Genus *Asemonea* O. P.-Cambridge, 1869

***Asemonea amatola* sp. n.**

Figs 2, 30, 31

Etymology: A noun in apposition, referring to the mountain range in which the type locality is found.

Diagnosis: The female has a distinctive epigynal structure, which is short and broad, with fissured gonopores. Male unknown.

Description:

Female.

Measurements. Cephalothorax: length 2.0, width 1.6. Abdomen: length 2.4, width 1.5. Eye field: length 0.7.

General appearance as in Fig. 2. Small, pale spiders. Carapace pear-shaped, eyes typical for Lyssomaninae, in four rows, situated on high tubercles, posterior median eyes relatively large. Carapace white, with delicate traces of two dark bands on thoracic part; eyes with black rings (except anterior medians). Fovea distinct. Chelicerae with three

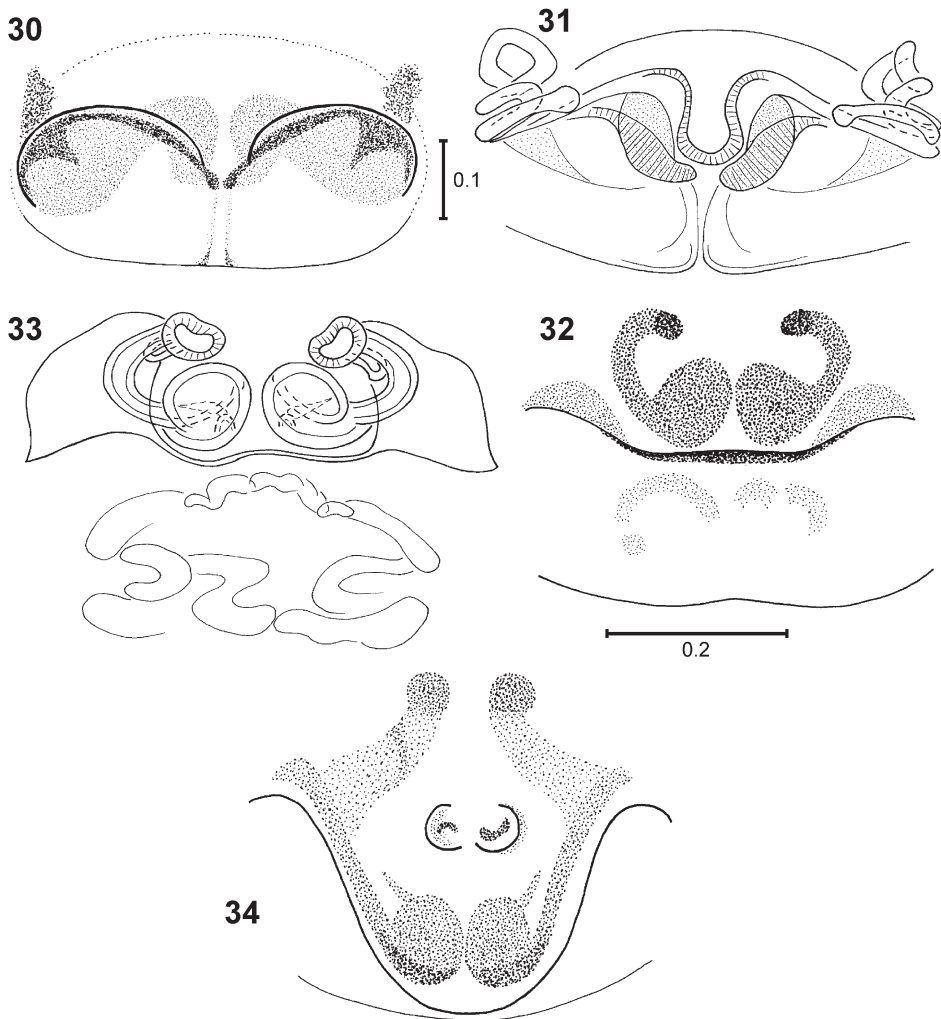

Figs 30–34. *Asemonea amatola* sp. n., holotype ♀ (30, 31), *A. clara* sp. n., paratype ♀ (32, 33) and *A. murphyae*, ♀ (34): (30, 32, 34) epigyne, ventral view; (31, 33) internal structure of epigyne.

small teeth on promargin and four on retromargin. Mouthparts and sternum whitish. Abdomen elongate, pale, with traces of dark lateral streaks anteriorly and five small blackish spots in posterior half. Venter pale. Spinnerets white. Delicate short light hairs covering entire body. Legs thin, white. First tibiae with single prolateral spine, two retrolateral and four pairs of ventral spines; metatarsi with three pairs on ventral surface. Pedipalp with six spines (five below and one above). Epigyne large, very broad, blackish, with two large shallow depressions (Fig. 30). Copulatory openings fissured, their surroundings strongly sclerotized (Fig. 31).

Holotype: ♀ SOUTH AFRICA: *Eastern Cape*: Amatola Mtns, Hogsback, Never Daunted Guest House, 32°35.6'S 26°56.8'E, canopy fogging, mixed garden shrubs, 10.iv.2010, C. Haddad (NCA, 2012/1106).

Distribution: Known only from the type locality (Fig. 35).

Habitat and biology: The species was collected from the canopy of mixed broadleaf trees in a garden.

***Asemonea clara* sp. n.**

Figs 32, 33

Etymology: From Latin *clara* (clear, plain), referring to the pale colouration of this species.

Diagnosis: The female is recognizable by the epigyne with a transverse median furrow and large pockets. Male unknown.

Description:

Female.

Measurements. Cephalothorax: length 1.9–2.0, width 1.3–1.4. Abdomen: length 2.2–2.4, width 1.2–1.4. Eye field: length 0.6.

Small spiders, pale lime-green in live specimens, in ethanol creamy-yellow. Carapace pear-shaped, low, eyes typical for Lyssomaninae, in four rows, situated on high tubercles, posterior median eyes relatively large. Carapace whitish, eyes surrounded by black rings (except anterior medians). Chelicerae with two small teeth on promargin and four on retromargin. Mouthparts and sternum pale. Abdomen white, with rounded small black patch in centre and black dot near posterior margin, and two short transverse dark lines on sides at anterior margin. Venter light. Spinnerets white. Whole body covered with fine pale hairs. Legs long and thin, white, tibiae of posterior legs with paired black markings at proximal and distal ends; tibiae of anterior legs with similar patches, but only on retrolateral sides; in some specimens such marks on tarsi of all legs retrolaterally. Tibia I with four pairs of ventral spines, prolaterally 1-1 and retrolaterally 1-0; metatarsus I with four pairs of ventral spines. Epigyne weakly sclerotized, with transverse median furrow and pair of large pockets (Fig. 32). Internal structure simple, as in Fig. 33; very weakly sclerotized canals visible posterior to furrow.

Holotype: ♀ SOUTH AFRICA: *KwaZulu-Natal*: Oribi Gorge Nature Reserve, Samango waterfall trail, 30°42.612'S 30°16.182'E, 200 m, canopy fogging, mixed forest trees, 13.i.2011, C. Haddad (NCA, 2010/2706).

Paratypes: SOUTH AFRICA: *Eastern Cape*: 1♀ Port St Johns, Cremorne Estate, 31°35.857'S 29°31.991'E, 43 m, night collecting, 10.i.2011, C. Haddad (NCA, 2010/2715); 6♀ Kei Mouth, 32°41.206'S 28°22.497'E, coastal forest, beats, 8.xii.2005, C. Haddad (NMBA). *KwaZulu-Natal*: 1♀ Ndumo Game Reserve, Pongola R., Water Pump, 26°54.309'S 32°19.444'E, 36 m, riverine forest, canopy fogging *Breonadia salicina*, 1.vii.2009, C. Haddad, R. Lyle & V. Butler (NMSA, 26515); 1♀ same data but 2.vii.2009 (NMSA, 26415); 8♀ Oribi



Fig. 35. Distribution of *Afromarengo bimaculata* (black circles), *Asemonea amatola* sp. n. (white circle), *A. clara* sp. n. (black squares) and *A. murphae* (white square) in South Africa.

Gorge Nature Reserve, together with holotype (NCA, 2010/2706); 2♀ same data as holotype (MRAC); 2♀ Port Edward, Umtamvuna River Lodge, 31°03.968'S 30°11.265'E, 64 m, night collecting, 12.i.2011, C. Haddad (NCA, 2010/2711).

Distribution: Species known from the eastern part of South Africa (Fig. 35).

Habitat and biology: A foliage-dwelling species collected mainly by beating and canopy fogging in coastal and lowland forests. Two females were collected at night from silk threads suspended from vegetation.

Asemonea murphyeae Wanless, 1980

Fig. 34

Asemonea murphyi: Wanless 1980: 231, figs 11A–E, 12A–C, 27.

Asemonea murphyeae: Wesolowska 2001: 579, figs 5–10.

Wanless (1980) described both sexes. Female epigyne as in Fig. 34.

Material examined: SOUTH AFRICA: *KwaZulu-Natal*: 1♀ Cathedral Peak Nature Reserve, Rainbow Gorge, 28°56.982'S 29°13.874'E, 1400 m, base of grasses and ferns, 19.i.2011, C. Haddad (NCA, 2010/2712).

Distribution: A species hitherto known only from Kenya, recorded for the first time in South Africa (Fig. 35).

Habitat and biology: This species was collected in low-growing vegetation near the soil surface in Afromontane grassland.

Genus *Belippo* Simon, 1910
***Belippo meridionalis* sp. n.**

Figs 3, 15, 36–42

Etymology: From Latin *meridionalis* (southern), referring to the distribution of the species relative to its congeners.

Diagnosis: The habitus of the male is similar to *Belippo cygniformis* Wanless, 1978 from Ghana, but it may be easily distinguished from it and other congeners by the cheliceral dentition: this species has a toothless promargin and only two teeth on the retromargin, whereas all of the other species have many teeth on both cheliceral edges. The female is difficult to recognize. The epigyne is similar to that of *B. ibadan* Wanless, 1978 from Nigeria, but lacks the lateral pouches.

Description:

Measurements (♂/♀). Cephalothorax: length 1.8/1.5, height 0.7/0.6. Abdomen: length 1.8/1.6, width 0.9/0.9. Eye field: length 0.8/0.7, anterior width 0.9/0.8, posterior width 1.0/0.9.

Male.

General appearance as in Figs 3, 15. Very small, ant-like spider. Carapace with shallow constriction behind eye field, widest at last row of eyes, delicately pitted, dark brown, darker near eyes, with some colourless bristles at anterior eyes and a few white scales on thoracic part. Clypeus very low. Chelicerae brownish orange, large, broad in middle of their length, with distal retrolateral spur; promargin toothless, retromargin with two teeth (Figs 36, 37). Mouthparts and sternum brown. Abdomen oval, with delicate constriction, broadest in posterior section; dorsum covered with two scuta (Fig. 15), dark brown with strong lustre. Sparse long thin colourless hairs cover abdomen, with white scales forming small submarginal patches behind anterior scutum. Venter brown with two pale bands. Spinnerets short, dark. Legs short, slender, yellow, first pair with slightly darker dorsal surfaces of femora and tibiae, others with dark line along femora, patellae and tibiae prolaterally. Four pairs of ventral spines on tibiae I, two pairs on metatarsi I; leg II with single spine on tibiae ventrally and two pairs on metatarsi, remaining leg segments spineless; tarsi with dense hairs ventrally. Pedipalps brown; palpal tibia with apical retrolateral denticles, tibial apophysis hidden in cymbial groove, sickle-shaped with small cog (Figs 38–40); embolus long, encircling bulb twice, with broad pars pendula (Fig. 38).

Female.

Similar to male, colouration slightly lighter, abdomen whitish ventrally with two dark areas laterally. Chelicerae shorter than in male, with four small teeth on promargin and five on retromargin. Tarsi of legs and pedipalps with very dense hairs. Epigyne very delicate, weakly sclerotized, without lateral pouches (Fig. 41). Internal structure as in Fig. 42, seminal ducts very long, forming a few loops, membranous, visible only after staining with chlorazol black; only their distal, narrow parts more strongly sclerotized; spermathecae aspherical.

Holotype: ♂ SOUTH AFRICA: *KwaZulu-Natal*: Ophathe Game Reserve, 28°25.344'S 31°23.957'E, 897 m, montane grassland, sifting leaf-litter, 4.x.2008, C. Haddad (NCA, 2008/3917).

Paratype: 1♀ 1 imm., same data as holotype (NCA, 2008/3917).

Distribution: Known from the type locality only (Fig. 49).

Habitat and biology: This species was found in leaf-litter amongst *Crematogaster* ants.

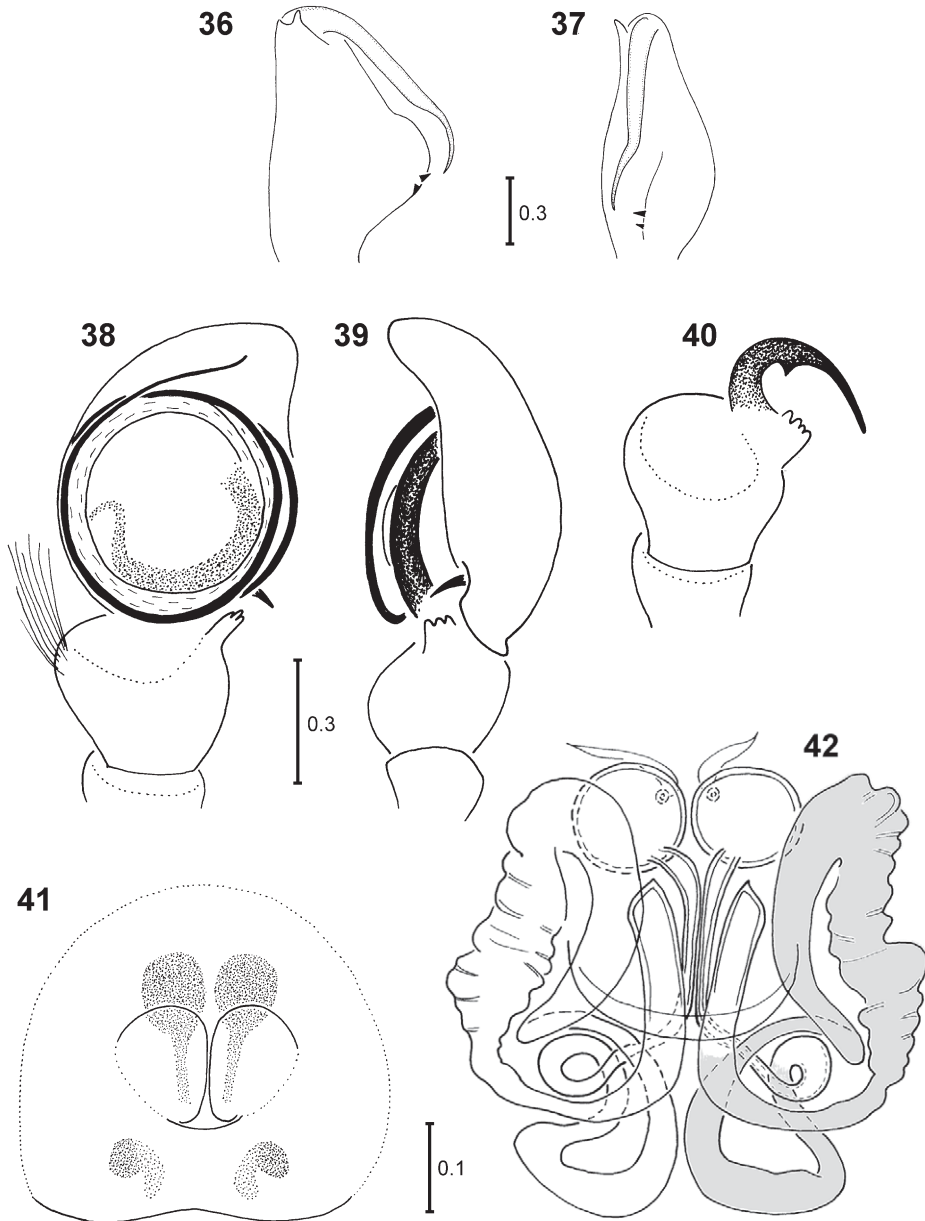

Figs 36–42. *Belippo meridionalis* sp. n., holotype ♂ (36–40) and paratype ♀ (41, 42): (36) ♂ chelicera, retromarginal view; (37) same, inner view; (38) palpal organ, ventral view; (39) same, lateral view; (40) palpal tibia, ventral view; (41) epigyne, ventral view; (42) internal structure of epigyne.

Genus *Brancus* Simon, 1902*Brancus mustelus* (Simon, 1902), **comb. n.**

Viciria mustela: Simon 1902: 48; 1903: 743, figs 885, 886; Lessert 1936: 297, figs 94, 95.

Viciria morigera: Peckham & Peckham 1903: 232, pl. 26, fig. 6.

Viciria parmata: Peckham & Peckham 1903: 234, pl. 26, fig. 5.

Evarcha mustela: Wesolowska & Cumming 2008: 176, figs 24–32; Wesolowska & Haddad 2009: 33.

Wesolowska & Cumming (2008) described both sexes.

Material examined: SOUTH AFRICA: *Eastern Cape*: 1♀ Idutywa, Dweza Forest Rest Camp [32°16'S 28°50'E], 20.xii.1980, P.G. Hawkes (NMSA, 26459); 1♀ Kei Mouth, 32°41.206'S 28°22.497'E, coastal dune forest, beats, 8.xii.2005, C. Haddad (NMBA). *KwaZulu-Natal*: 1♂ Zululand, "Cascades" Farm, 10 km W of Eshowe, Kloof forest, 28°50'S 31°25'E, 520 m, 8.xi.1983, B. Digby (NMSA, 26485).

Distribution: Distributed in western and southern Africa; in South Africa only hitherto known from KwaZulu-Natal Province, recorded here from the Eastern Cape for the first time (Fig. 49).

Remarks: This species was originally described in *Viciria* Thorell, 1877 and then provisionally included in *Evarcha* Simon, 1902 by Wesolowska and Cumming (2008), but is closely related to members of *Brancus* Simon, 1902. It has a slender body with a slightly pear-shaped carapace, elongated narrow abdomen and long legs. The colouration of the female is pale with a contrasting pattern (transverse bands on abdomen and characteristic tear-shaped spots in the foveal area), consistent with other *Brancus* (see Wesolowska & Russell-Smith 2011 and Wesolowska & Edwards 2012). The structure of the female genitalia is typical for *Brancus* (see Wesolowska & Cumming 2008: figs 30–32: sub. *Evarcha m.*).

Genus *Colaxes* Simon, 1900***Colaxes benjamini* sp. n.**

Figs 4–6, 16, 43–48

Etymology: Named after Suresh P. Benjamin, who recently revised the subfamily Ballinae and described *Colaxes* species from Sri Lanka.

Diagnosis: The female differs from congeners in the shape of the median epigynal septum, which is clearly delimited anteriorly from the depression. The male has a thinner tibial apophysis than in congeners. It can also be separated from members of *Ballus* C.L. Koch, 1850 by the proportions of the carapace (longer than wide in *Colaxes*).

Description:

Measurements (♂/♀). Cephalothorax: length 1.6–1.7/1.3–1.6, width 1.3–1.4/1.1–1.3, height 0.4–0.5/0.3–0.4. Abdomen: length 1.9–2.0/1.7–2.2, width 1.1–1.3/1.2–1.5. Eye field: length 0.6–0.7/0.5–0.6, anterior width 0.9–1.0/0.8–1.0, posterior width 1.0–1.1/1.0–1.1.

Male.

General appearance as in Figs 4, 16. Very small, strongly flattened spider. Carapace longer than wide, brown, darker marginally; eye field slightly lighter, two rounded black patches in centre of ocular area (Fig. 4); eyes surrounded by blackish rings. Fovea long, poorly visible. Integument of carapace with delicate granulation; carapace covered in short grey hairs, with long brown bristles near anterior eyes. Clypeus extremely low. Chelicerae with three small teeth on retromargin. Sternum and endites pale brown. Ab-

domen broader than carapace, flat, black with series of creamy-yellow patches (Fig. 4). Venter dark with large cream patches. Spinnerets pale brown. First leg brownish, femora and tibiae swollen (Fig. 43); tibiae I with 0-1 spines prolaterally and 1-1 spines retrolaterally; remaining legs yellow, with dark lines along lateral surfaces of femora II–IV (more prominent on prolateral sides) and dark marks on bases of patellae and tibiae. Pedipalps with thin tibial apophysis; tegulum divided by pale furrow, embolus coiled, spiral short (Figs 44–46).

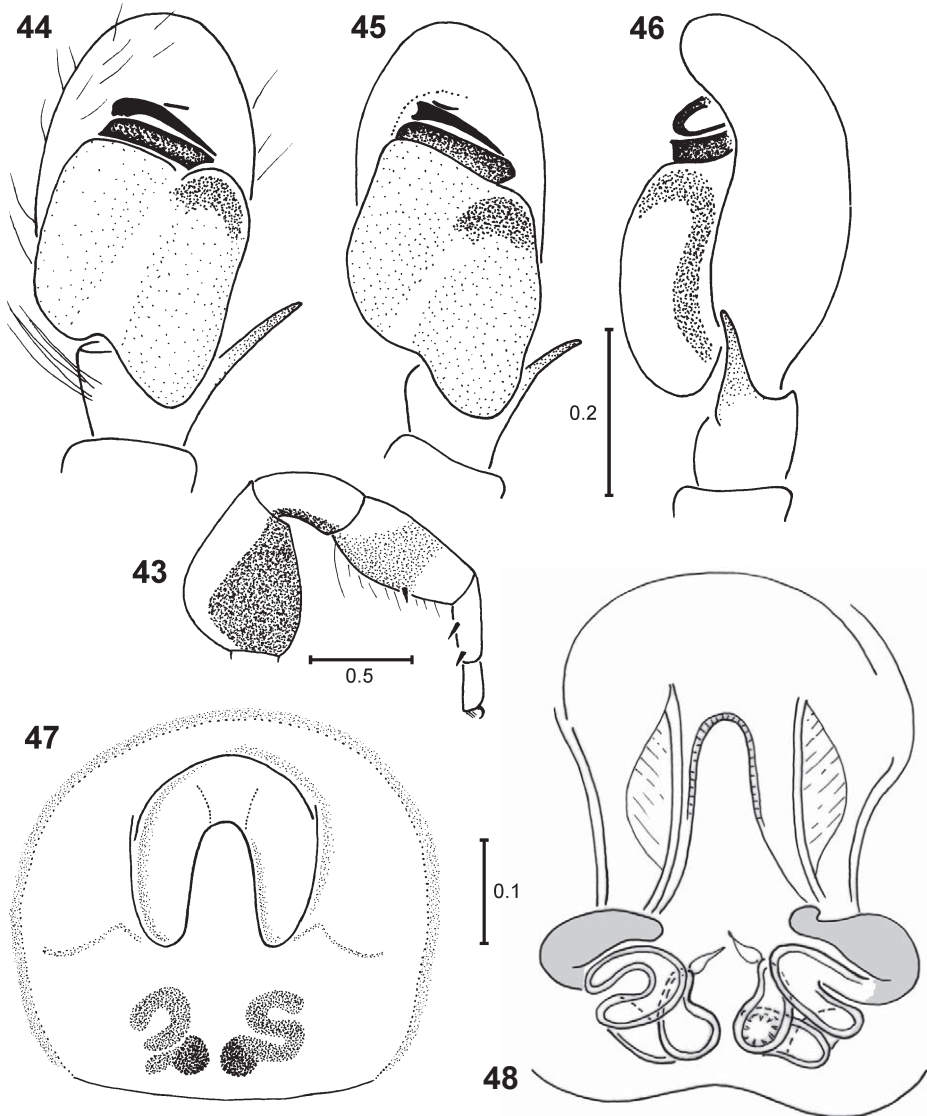

Figs 43–48. *Colaxes benjamini* sp. n., paratype ♂ (43–46) and paratype ♀ (47, 48): (43) first leg of ♂; (44) palpal organ, ventral view; (45) same, ventrolateral view; (46) same, lateral view; (47) epigyne, ventral view; (48) internal structure of epigyne.

Female.

General appearance similar to male (Figs 5, 6). All legs yellow, first pair not swollen; dark lines present along pro-lateral surfaces of femora, patellae and tibiae of legs I and IV; tibiae I with two pairs of ventral spines, metatarsi with the same pattern; tibiae II with one pair of ventral spines; other legs spineless. Pedipalp pale, with dark lines pro- and retrolaterally. Epigyne with horse-shoe shaped depression and translucent median septum (Fig. 47). Initial parts of seminal ducts very weakly sclerotized, membranous (Fig. 48).

Holotype: ♂ SOUTH AFRICA: *KwaZulu-Natal*: Ophathe Game Reserve, 28°22.135'S 31°23.363'E, 560 m, overgrazed savanna, beating short shrubs, 3.x.2008, C. Haddad (NCA, 2008/4138).

Paratypes: SOUTH AFRICA: *Eastern Cape*: 1♀ Amatola Mtns, Hogsback, 32°35.605'S 26°56.153'E, invaded forest, canopy fogging *Podocarpus falcatus*, 9.iv.2010, C. Haddad, V. Swart & A. Kirk-Spriggs (NCA, 2012/1117); 1♂ 1♀ same data but 8.iv.2010 (NCA, 2012/1095); 1♀ same locality, 32°35.605'S 26°56.153'E, invaded forest, beating shrubs, 26.iii.2011, University of the Free State students (NCA, 2012/1826); 2♂ 2♀ same locality, 32°35.987'S 26°55.880'E, 1140 m, Afromontane forest, canopy fogging *Xymalos monospora*, 3.iv.2012, C. Haddad, J. Neethling, A. van Rooyen & R. du Preez (NMSA, 26420); 2♀ same data but 32°35.960'S 26°55.865'E, 1145 m (NMSA, 26448). *KwaZulu-Natal*: 7♀ Ophathe Game Reserve, together with holotype (NCA, 2008/4138); 1♂ 1♀ same data as holotype (MRAC); 2♂ 10♀ same data as holotype (NCA, 2008/4151); 2♂ 12♀ same locality, 28°23.202'S 31°24.077'E, 505 m, rocky mountainside, beating short shrubs, 1.x.2008, C. Haddad (NCA, 2008/3976); 6♀ same data (NCA, 2008/3994); 1♀ same locality, 28°25.344'S 31°23.957'E, 897 m, montane grassland, beating short shrubs, 4.x.2008, C. Haddad (NCA, 2008/3964); 1♂ 2♀ same locality, 28°23.727'S 31°23.643'E, 455 m, Ophathe R. bed, beating short shrubs, 2.x.2008, C. Haddad (NCA, 2008/4164); 1♀ Oribi Gorge Nature Reserve, Samango waterfall trail, 30°42.612'S 30°16.182'E, canopy fogging, mixed forest trees, 13.i.2011, C. Haddad (NCA, 2010/2714).



Fig. 49. Distribution of *Belippo meridionalis* sp. n. (black circle), *Brancus mustelus* (white circles) and *Colaxes benjamini* sp. n. (black stars) in South Africa.

Distribution: Known from the Eastern Cape and KwaZulu-Natal provinces (Fig. 49).

Habitat and biology: The species lives on the foliage of trees in forests and savannas and was collected by fogging and beating.

Remark: This is the first member of *Colaxes* Simon, 1900 discovered in Africa. *Colaxes* is a small genus and previously included only three species distributed in southern India and Sri Lanka (Benjamin 2004).

Genus *Dendryphantes* C.L. Koch, 1837

***Dendryphantes limpopo* sp. n.**

Figs 7, 50, 51

Etymology: From the Limpopo Province, where the type series was collected; a noun in apposition.

Diagnosis: The female is distinguished by the epigyne with strongly sclerotized spiral lips around copulatory openings. The species is related to *Dendryphantes arboretus* Wesolowska & Cumming, 2008 from Zimbabwe; both species have large spherical vesicles near the midpoint of the seminal ducts, which are absent in other *Dendryphantes* species. The newly described species differs from *D. arboretus* by the clearly longer seminal ducts that form a few loops (straight in *D. arboretus*), by the form of the sclerotization of the surroundings of the copulatory openings, and by the shape of the posterior epigynal edge. Male unknown.

Description:

Female.

Measurements. Cephalothorax: length 1.3–1.5, width 0.9–1.0, height 0.4. Abdomen: length 1.9–2.0, width 1.3. Eye field: length 0.6–0.7, anterior width 0.8–0.9, posterior width 0.9–1.0.

General appearance as in Fig. 7. Body flattened, typical for the genus. Carapace oval, dark brown, covered with delicate fine hairs. Eye field almost black, with metallic lustre;

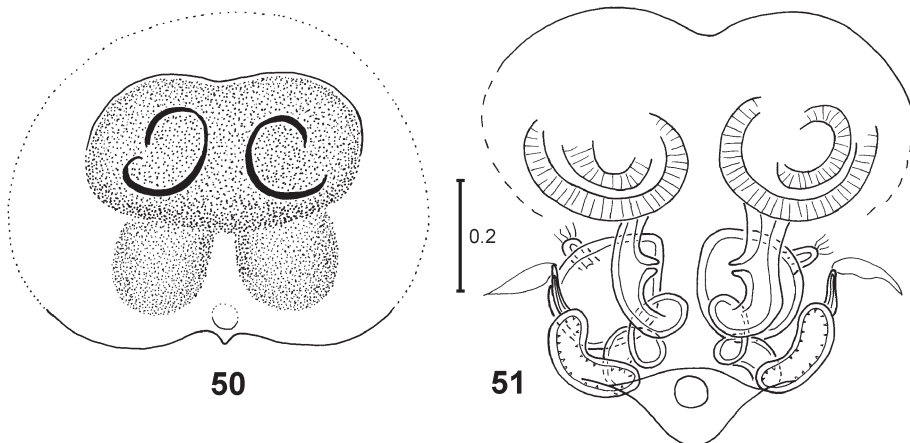

Figs 50, 51. *Dendryphantes limpopo* sp. n., paratype ♀: (50) epigyne, ventral view; (51) internal structure of epigyne.

surface pitted, with some brown bristles near eyes. Clypeus very low, dark. Chelicerae unidentate. Sternum pale brown, labium darker, endites with paler tips. Abdomen ovoid, dark brown, with pattern consisting of a few pairs of creamy-white patches; pattern poorly contrasted; dorsum clothed in fine brown and colourless hairs. Sides of abdomen dark brown. Venter almost black with large triangular yellowish patch. Spinnerets black. Legs brown, II–IV with yellow-brown stripes on dorsal surfaces of femora and creamy-yellow rings on distal segments. Leg hairs brown. Epigyne oval, with large wide anterior depression (Fig. 50), partially plugged with waxy secretion. Atria depressed with strongly sclerotized circular lips; seminal ducts long, forming three loops, accompanying by large spherical vesicles; accessory glands present (Fig. 51).

Holotype: ♀ SOUTH AFRICA: *Limpopo*: Naboomspruit [=Mookgopong], Rhemardo Holiday Resort, 24°26.871'S 28°36.731'E, 1300 m, canopy fogging *Berchemia zeyheri*, 1.ii.2011, C. Haddad, V. Butler & J. Neethling (NCA, 2012/1818).

Paratypes: SOUTH AFRICA: *Limpopo*: 1♀ together with holotype (NCA, 2012/1818); 2♀ same locality as holotype, 24°26.831'S 28°36.529'E, 1310 m, canopy fogging *Dombeya rotundifolia*, 3.ii.2011, C. Haddad, S. Foord & V. Butler (NCA, 2012/1819).

Distribution: Known only from the type locality (Fig. 61).

Habitat: Collected from broad-leaved deciduous trees by canopy fogging in savanna woodland.

Dendryphantes rafalskii Wesołowska, 1999

Fig. 52

Dendryphantes rafalskii: Wesołowska 1999: 147, figs 5–10.

Wesołowska (1999) described both sexes; general appearance of female in Fig. 52.

Material examined: SOUTH AFRICA: *Free State*: 1♀ Bloemfontein, Free State National Botanical Gardens, 29°03'S 26°12'E, beats, *Searsia lancea*, 30.xi.2010, J. Neethling (NMBA).

Distribution: Previously known only from Zimbabwe, recorded for the first time from South Africa (Fig. 61).

Habitat and biology: This species was sampled by beating foliage. Large numbers of juveniles with the same distinctive abdominal markings were also collected by fogging *Olea europaea* trees at the Free State National Botanical Gardens during February, but no adults were present in the samples.



Figs 52, 53. Living specimens of a *Dendryphantes rafalskii* ♀ (52) and an *Ureta quadrispinosa* ♂ (53). (Photo 52 by Johan van Zyl and 53 by Charles Haddad)

Dendryphantes silvestris sp. n.

Figs 8, 54–60

Etymology: From Latin *silvestris* (of a forest), referring to the habitat of the species.

Diagnosis: This species may be easily distinguished from congeners: the male by the distinctive, very long and thin embolus accompanied by a very long terminal apophysis, and the female by having very deep epigynal atria.

Description:

Measurements (♂/♀). Cephalothorax: length 2.0/1.8–2.0, width 1.5/1.4–1.5, height 0.7/0.6–0.7. Abdomen: length 2.2–2.3/2.3–2.5, width 1.5–1.8/1.5–1.7. Eye field: length 0.8/0.8, anterior width 1.2/1.2–1.3, posterior width 1.3/1.3–1.4.

Male.

General appearance as in Fig. 8. Shape of body typical for the genus, slightly elongated and very flattened. Carapace oval, brown, with yellow-silver translucent guanine crystals spread throughout eye field; two rounded black stains present in centre of ocular area (Fig. 8). Eyes surrounded by black rings. Dorsum of carapace clothed in dense short greyish hairs; long brown bristles near anterior row of eyes. Clypeus low, brown. Mouthparts and sternum dark. Abdomen ovoid, generally dark; dense small brown patches and dots forming pattern on yellowish grey background (Fig. 8); abdominal dorsum with brown and grey hairs. Venter with broad dark area, with two lines formed by pale dots on it. Spinnerets grey. Legs brown, first pair slightly stouter than others; sides of femora, tibiae and patellae almost black. Leg hairs and spines dark. Pedipalps dark brown; tegulum oval, embolus very long and thin, terminal apophysis also long (Figs 54–56).

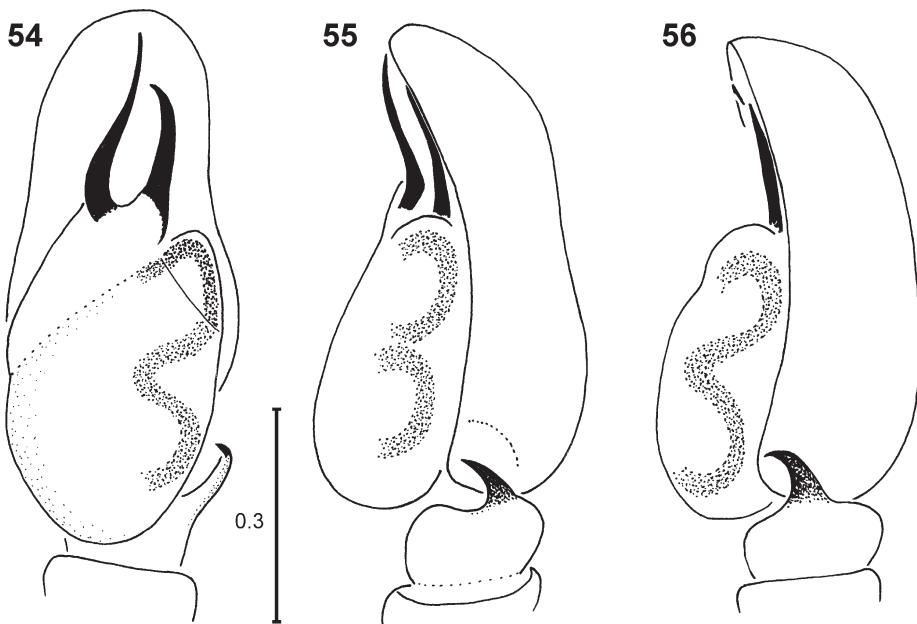

Figs 54–56. *Dendryphantes silvestris* sp. n., paratype ♂: (54) palpal organ, ventral view; (55) same, ventrolateral view; (56) same, lateral view.

Female.

Similar to male, slightly lighter in colour. Anterior eyes surrounded by white hairs. Clypeus clothed in whitish hairs. Spinnerets grey. Legs yellow, lateral surfaces of proximal segments sometimes darker. Epigyne with copulatory openings hidden in very deep sclerotized atria (Figs 57, 58); accessory glands lead into the ducts in their inlet parts (Figs 59, 60).

Holotype: ♂ SOUTH AFRICA: *Eastern Cape*: Amatola Mtns, Hogsback, 32°35.649'S 26°56.638'E, beating shrubs, Afromontane forest, 9.iv.2010, University of the Free State students (NCA, 2012/1098).

Paratypes: SOUTH AFRICA: *Eastern Cape*: 2♂ 5♀ Amatola Mtns, Hogsback, 32°35.605'S 26°56.153'E, invaded forest, canopy fogging *Podocarpus falcatus*, 9.iv.2010, C. Haddad, V. Swart & A. Kirk-Spriggs

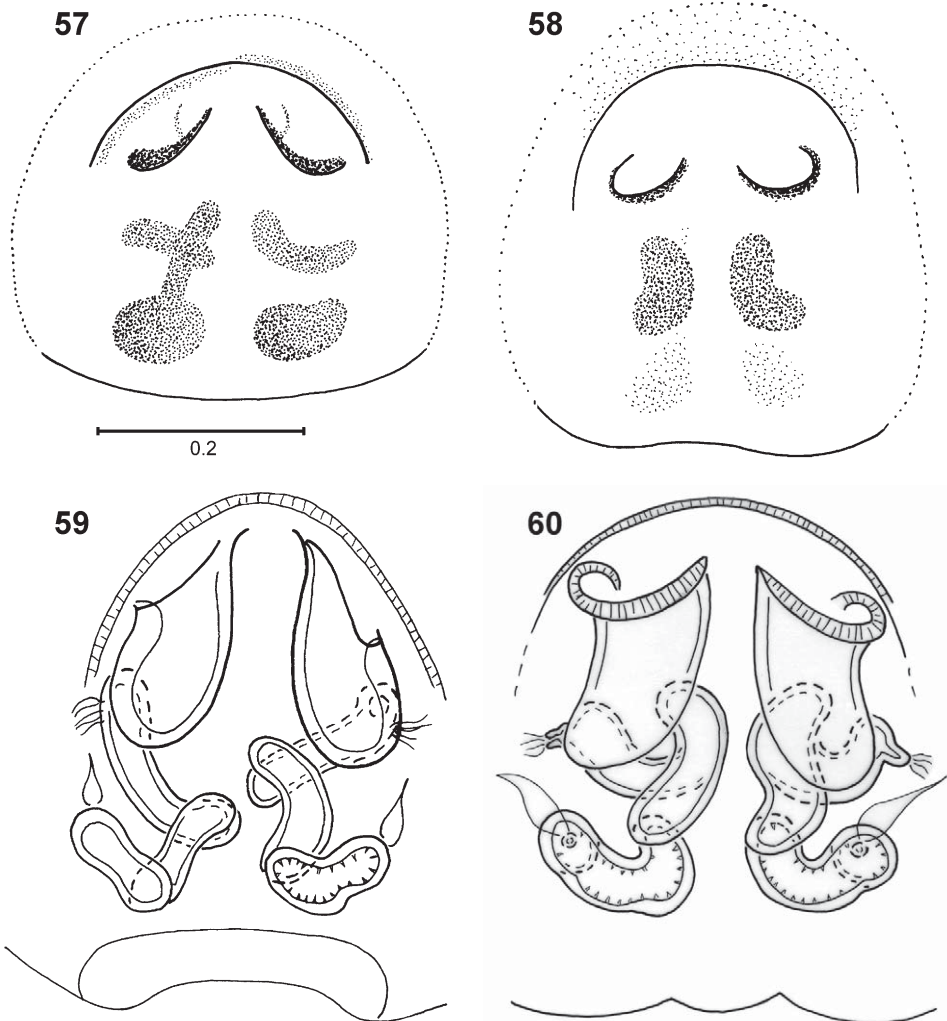

Figs 57–60. *Dendryphantes silvestris* sp. n., paratype ♀♀: (57, 58) epigynes, ventral view; (59, 60) internal structure of epigynes.

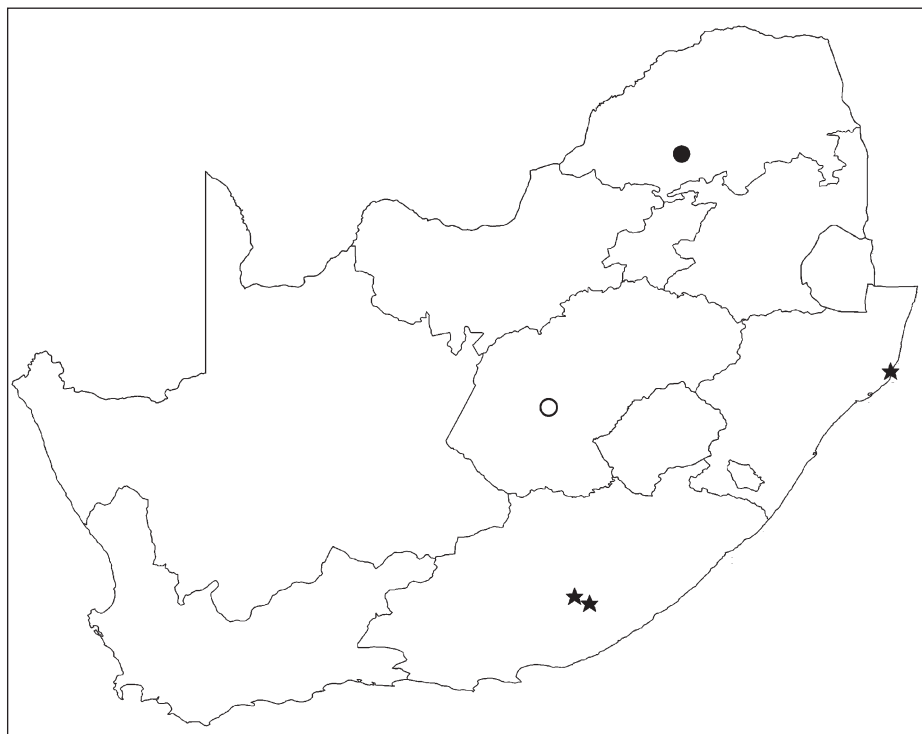

Fig. 61. Distribution of *Dendryphantès limpopo* sp. n. (black circle), *D. rafalskii* (white circle) and *D. silvestris* sp. n. (black stars) in South Africa.

(NCA, 2012/1122); 2♂ 1♀ same locality, 32°35.605'S 26°56.153'E, canopy fogging *P. falcatus*, 8.iv.2010, C. Haddad, V. Swart & A. Kirk-Spriggs (NCA, 2012/1115); 1♂ 1♀ same data (MRAC); 7♀ same locality, 32°35.508'S 26°56.538'E, 1210 m, pine plantation, canopy fogging *P. falcatus*, 1.iv.2012, C. Haddad & J. Neethling (NMBA); 1♂ same data (NMBA); 4♀ same locality, 32°35.530'S 26°56.570'E, 1200 m, pine plantation, canopy fogging *P. falcatus*, 1.iv.2012, C. Haddad & J. Neethling (NMSA, 26427); 2♀ Amatola Mtns, Katberg State Forest, 32°28.407'S 26°40.346'E, 1210 m, Afromontane forest, canopy fogging, mixed trees, 8.i.2011, C. Haddad, C. Griswold & H. Wood (NCA, 2010/2710). *KwaZulu-Natal*: 1♂ iSimangaliso Wetlands Park, St Lucia, 28°23.038'S 32°24.428'E, 21 m, coastal forest, canopy fogging *Trichilia dregeana*, 13.v.2012, J. Neethling & C. Luwes (NMSA, 26437).

Distribution: Known only from two localities in the Amatola Mountains and a single locality in northern KwaZulu-Natal (Fig. 61).

Habitat: The species was mainly collected from yellow-wood trees and mixed tree canopies by fogging in indigenous Afromontane forests invaded by exotic species (Hogsback) and undisturbed forest (Katberg), respectively. Single specimens were collected by beating shrubs in Afromontane forest and by fogging a tree in coastal forest.

Genus *Evarcha* Simon, 1902

***Evarcha denticulata* sp. n.**

Figs 9, 62–64

Etymology: From Latin *denticulata* (notched), in reference to the tooth on the palpal tibial apophysis.

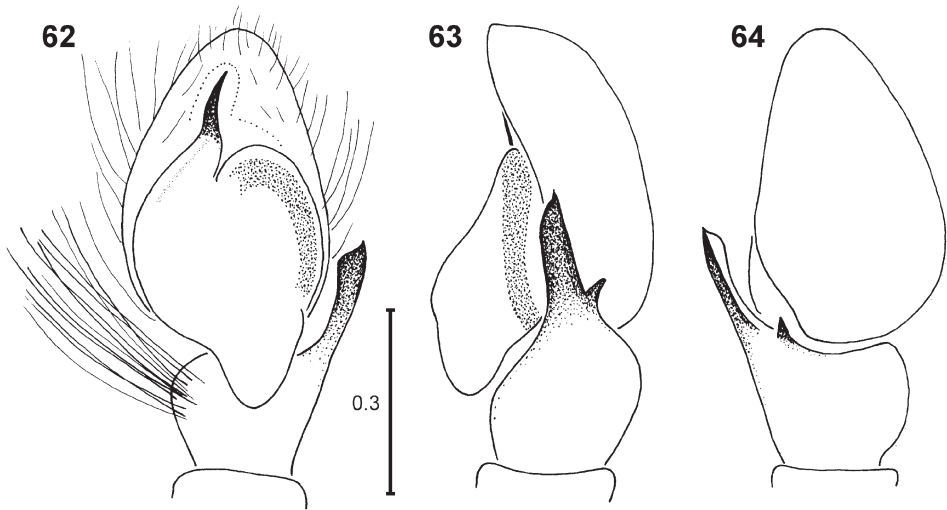

Figs 62–64. *Evarcha denticulata* sp. n., holotype ♂: (62) palpal organ, ventral view; (63) same, lateral view; (64) same, dorsal view.

Diagnosis: The species is related to *Evarcha vittula* Haddad & Wesolowska, 2011, but can be easily distinguished by the shape of the tibial apophysis (longer and with an additional tooth). It also differs in body colouration (Fig. 9), having a generalised T-shaped marking on the abdomen, while *E. vittula* has creamy median stripe on the carapace and abdomen (see Haddad & Wesolowska 2011: fig. 39). Female unknown.

Description:

Male.

Measurements. Cephalothorax: length 2.1, width 1.5, height 0.1. Abdomen: length 1.8, width 1.2. Eye field: length 1.0, anterior width 1.3, posterior width 1.4.

General appearance as in Fig. 9. Carapace high, blackish brown, with flat area extending halfway along the thorax; flat part of thorax slightly bright brown, with belt of white hairs along lateral edges of eye field, converging towards posterior of carapace. Anterior median eyes surrounded by fawn scales above and white scales below; long brown bristles present on eye field, especially at posterior median eyes; white hairs forming three fine parallel lines below anterior lateral eyes on “cheeks”; clypeus with few long white bristles. Mouthparts and sternum dark brown. Abdomen blackish brown, with streak formed by white hairs along anterior edge and white median band, broken into chain of large spots posteriorly. Venter dark, with four lines formed by pale dots. Spinnerets dark. Legs dark brown, hairs and spines dark brown, some lighter hairs on distal ends of femora. Pedipalps dark brown; tibial apophysis long, tip broadened in ventral view, with additional dorsal tooth; embolus short and slightly curved (Figs 62–64).

Holotype: ♂ SOUTH AFRICA: *Eastern Cape*: 10 km NE of Paterson, 33°21.175'S 25°57.239'E, base of grass tussocks, 4.xi.2011, C. Haddad (NCA, 2012/1827).

Paratypes: SOUTH AFRICA: *Eastern Cape*: 3♂ Amatola Mtns, Hogsback, Amatola Forestry Company offices, 32°35.276'S 26°55.911'E, 1270 m, under overhanging vegetation, 2.iv.2012, C. Haddad, J. Neethling & A. van Rooyen (NMSA, 26518); Jeffrey's Bay, Kabeljauws, 34°00.415'S 24°55.795'E, 7 m, on lawn in garden, 22.xii.2012, C. Haddad (NCA, 2013/568). *Western Cape*: 1♂ Cape Town, Rondebosch, Chess Road, 33°55'S 18°25'E, ii.2012, M. Cumming (MRAC).

Distribution: Known only from the southern parts of South Africa (Fig. 67).

Habitat and biology: Specimens were collected on the soil surface underneath overhanging vegetation or from the base of grass tussocks.

Evarcha mirabilis Wesolowska & Haddad, 2009

Evarcha mirabilis: Wesolowska & Haddad 2009: 32, figs 38–41.

Wesolowska & Haddad (2009) described both sexes.

Material examined: SOUTH AFRICA: *Western Cape*: 1♂ De Hoop Nature Reserve, Lekkerwater road, 34°24.023'S 20°33.189'E, under *Thamnochortus restios*, 26.iii.2005, C. Haddad (NMBA).

Distribution: Species previously known only from the north-eastern part of South Africa, reported here for the first time from the south-western parts (Fig. 67).

Habitat and biology: This ground-dwelling species was originally described from savanna, and is recorded here for the first time from fynbos vegetation.

Evarcha striolata Wesolowska & Haddad, 2009

Figs 10, 17, 65, 66

Evarcha striolata: Wesolowska & Haddad 2009: 33, figs 47–49, 213, 214.

Wesolowska & Haddad (2009) described the male.

Description:

Female.

Measurements. Cephalothorax: length 2.5–2.6, width 1.9–2.0, height 1.1–1.2. Abdomen: length 2.4–2.5, width 1.4–1.5. Eye field: length 1.0–1.1, anterior width 1.5–1.6, posterior width 1.7–1.8.

General appearance as in Fig. 10. Carapace high, convex (Fig. 17), yellowish orange; eye field yellow; eyes with black rings; small white scales close to anterior median eyes; carapace with scattered brown hairs, with few bristles anteriorly on eye field. Clypeus moderately high, clothed in colourless hairs. Mouthparts and sternum dark yellow. Abdomen smaller than carapace, ovoid, tapering posteriorly; dorsum yellowish white, with ill-defined traces of two longitudinal streaks composed of small beige dots (Fig. 10). Venter whitish with two lines of beige dots. Spinnerets white. Legs orange, with

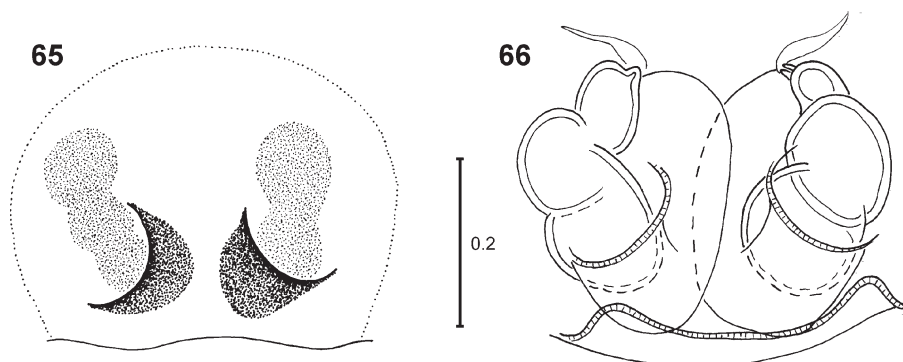

Figs 65, 66. *Evarcha striolata*, ♀: (65) epigyne, ventral view; (66) internal structure of epigyne.

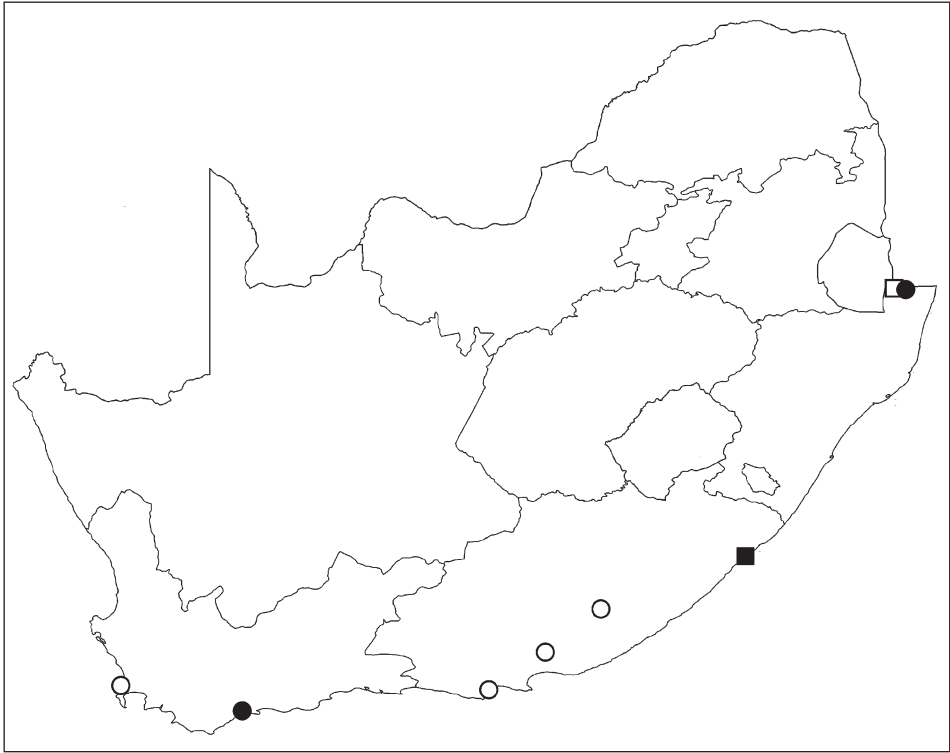

Fig. 67. Distribution of *Evarcha denticulata* sp. n. (white circles), *E. mirabilis* (black circles), *E. striolata* (white square) and *E. zimbabwensis* (black square) in South Africa.

brown spines and hairs. Epigyne with two widely separated rounded grooves and very wide pocket at epigastric fold (Fig. 65). Seminal ducts weakly sclerotized, very broad, forming a loop; spermathecae with a few chambers (Fig. 66).

Material examined: SOUTH AFRICA: *KwaZulu-Natal*: 1♂ Ndumo Game Reserve, southern boundary fence, 26°53.204'S 32°10.641'E, *Acacia tortilis* savanna, grass litter, 4.vii.2009, C. Haddad, R. Lyle & V. Butler (TMSA, 23530); 1 imm. 2♀ same data but 10.xii.2009, C. Haddad (NMBA); 1 imm. 1♂ same locality, Matandeni road, 26°53.252'S 32°11.516'E, base of grass tussocks, 7.viii.2009, C. Haddad, R. Lyle & V. Butler (TMSA, 23569).

Distribution: Known only from the type locality (Ndumo Game Reserve, Fig. 67).

Habitat and biology: Most of the known specimens were collected from the base of grass tussocks or grassy litter in *Acacia tortilis* savanna.

Remarks: The female, described here for the first time, is very similar to that of *E. flagellaris* Haddad & Wesołowska, 2011, but is lighter in colour, with a more slender body and a clearly more convex carapace. The internal structure of the epigyne also similar, but the spermathecae are composed of fewer chambers than in *E. flagellaris*.

Evarcha zimbabwensis Wesołowska & Cumming, 2008

Evarcha zimbabwensis: Wesołowska & Cumming 2008: 179, figs 38–43.

Wesołowska & Cumming (2008) described both sexes.

Material examined: SOUTH AFRICA: *Eastern Cape*: 1♂ Silaka Nature Reserve, 31°39.176'S 29°30.098'E, 155 m, base of grasses and ferns, 11.i.2011, C. Haddad (NCA, 2010/2707).

Distribution: Hitherto known only from Zimbabwe, recorded here for the first time from South Africa (Fig. 67).

Habitat and biology: A ground-dwelling spider collected in coastal forest.

Genus *Habrocestum* Simon, 1876
Habrocestum africanum Wesolowska & Haddad, 2009

Fig. 18

Habrocestum africanum: Wesolowska & Haddad 2009: 38, figs 62–67.

Wesolowska & Haddad (2009) described both sexes; general appearance of the female as in Fig. 18.

Material examined: SOUTH AFRICA: *KwaZulu-Natal*: 8 imm. 13♂ 2♀ Ophathe Game Reserve, 28°23.202'S 31°24.077'E, 505 m, rocky mountainside, pitfall traps, 29.ix–3.x.2008, C. Haddad (NCA, 2008/4026); 3♂ 1♀ same data but 1.x.2008, active searching (NCA, 2008/4057); 1♂ same locality, 28°23.727'S 31°23.643'E, 455 m, Ophathe R. bed, sifting leaf-litter, 2.x.2008, C. Haddad (NCA, 2008/4213). *Western Cape*: 2♀ De Hoop Nature Reserve, Potberg, 34°22.719'S 20°32.216'E, sifting leaf-litter, transition between *Eucalyptus* plantation and fynbos, 24.iii.2005, C. Haddad (NMBA).

Distribution: Until now known only from the type locality (Ndumo Game Reserve); recorded here from a second locality in KwaZulu-Natal and also for the first time from the Western Cape Province, expanding the range of the species more than 1500 km south-west (Fig. 71).

Habitat and biology: This is a leaf-litter spider that may be quite locally abundant (see also Wesolowska & Haddad 2009) in pitfall traps and leaf-litter samples in savanna habitats. The first record from the Fynbos biome provided here indicates that the species has a much broader habitat preference than previously indicated.

Habrocestum albimanum Simon, 1901

Figs 68–70

Habrocestum albimanum: Simon 1901: 71.

Diagnosis: The male has a unique embolus form, composed of two branches joined by a membrane, and may be also recognized by the presence of a tuft of white hairs at the base of the cymbium dorsally. Female unknown.

Redescription:

Male.

Measurements. Cephalothorax: length 2.6, width 2.0, height 1.3. Abdomen: length 2.2, width 1.8. Eye field: length 1.1, anterior width 1.7, posterior width 1.6.

Medium-sized, hairy spider. Carapace oval, high, with very steep posterior slope; eye field short, distance between anterior lateral eyes slightly larger than between posterior laterals; carapace dark brown, eyes black; carapace with thin median white line along thoracic part, short greyish brown hairs covering sides, and dense thick blunt bristles on eye field. Clypeus moderately high, dark; anterior eyes encircled by fawn hairs. Chelicerae unidentate. Labium and sternum dark brown, endites with slightly paler chewing margins. Abdomen small, narrower than carapace, dark brown, with wide pale transverse band anteriorly and large triangular patch in posterior half. Venter dark yellow,

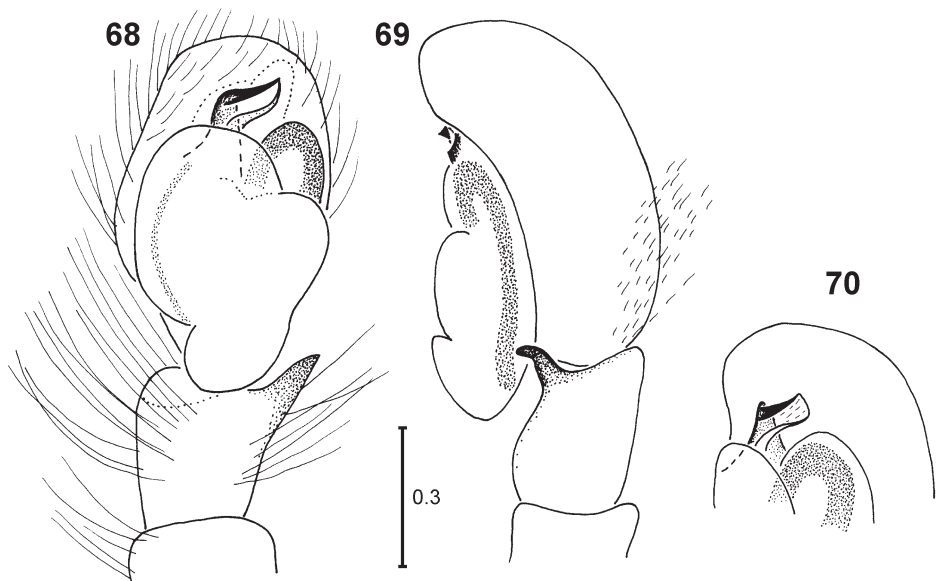

Figs 68–70. *Habrocestum albimanum*, ♂: (68) palpal organ, ventral view; (69) same, lateral view; (70) embolic division, ventrolateral view.

with broad brown streak and two lateral lines composed of dark dots. Hairs corresponding to background colour cover dorsum of abdomen, with longer bristles among them. Spinnerets brownish. Legs dark brown, coxae, trochanters and lateral surfaces of femora orange. Leg hairs dense, long, brown and greyish. Pedipalps faint brown, clothed in dense long dark hairs, with dense white hairs only on prolateral sides of patella, tibia and base of cymbium. Palp with short tibial apophysis, slightly bent ventrally near tip; embolus composed of two branches joined by membrane (Figs 68–70).

Material examined: SOUTH AFRICA: *Western Cape*: 1 ♂ Malmesburg, Yzerfontein, 33°21'S 18°07'E, under plants, 25.x.1973, L. Lotz (NMBA).

Distribution: Species known only from South Africa (Fig. 71).

Habitat and biology: As for most *Habrocestum*, this species appears to be a ground-dweller.

Remarks: The specimen was determined on the basis of the original description and of drawings of the specimen from Cape Town kept in the MCZ (Prószyński 2012).

Genus *Hasarius* Simon, 1871
Hasarius adansonii (Audouin, 1826)

Attus adansonii: Audouin 1826: 169, pl. 7, fig. 8.

Attus tardigradus: Audouin 1826: 171, pl. 7, fig. 13.

Attus nigro-fuscus: Vinson 1863: 59, 302, pl. 10, fig. 8.

Plexippa nigrofusca: Simon 1864: 326.

Eris niveipalpis: Gerstäcker 1873: 477.

Salticus scabellatus: Butler 1876: 441; 1879: 507, pl. 52, fig. 9.

Hasarius adansonii: Clark & Benoit 1977: 102, figs 45a–c; Wanless 1984a: 49, figs 16a–d; Prószyński 1987: 14 (misidentified, actually ♀ of *Nigorella plebeja* (L. Koch, 1875)); Ledoux 2007: 24, figs 20A–B, 21; Saaristo 2010: 182, figs 27, 43–46.

Hasarius albocircumdatus: Saaristo 1978: 111, figs 106–108.

Prószyński & Deeleman-Reinhold (2010) described both sexes.

Material examined: SOUTH AFRICA: *Eastern Cape*: 1♀ Dwesa Nature Reserve, 32°16'S 28°52'E, pitfall trap, 1.x.2004, M. Mgobozi (NCA, 2010/1250); 1♂ East London, Pineapple Research Station, 33°01'S 27°54'E, pitfall trap, 2.xii.1977, G. Petty (NCA, 96/391); 1♂ 1♀ same data (NCA, 96/394); 2♀ Kei Mouth, 32°41.280'S 28°22.484'E, coastal forest, litter, 26.xii.2003, C. Haddad (NMBA); 1♂ 1♀ King William's Town, 32°52'S 27°23'E, in building 1.iii.1973, P. Swanepoel (NCA, 76/1719); 1♂ 1♀ Mazeppa Bay, 32°28.476'S 28°38.873'E, coastal dune forest, beats, 28.x.2006, R. Lyle & C. Haddad (NCA, 2007/426). *Free State*: 1♂ Bloemfontein, National Museum, 29°08'S 26°10'E, 30.i.1995, in museum, L. Lotz (NMBA); 1♀ same data but 24.ii.1997 (NMBA); 1♂ same data but 23.iv.1998 (NMBA); 1♂ same data but 1.xii.1999 (NMBA); 1♂ same data but 6.ii.2002 (NMBA). *Gauteng*: 1♂ Pretoria [Tshwane], 25°44'S 28°11'E, 1.xii.1987, M. Johnson (NCA, 87/396); 1♀ same locality, 25°44'S 28°11'E, sweepnet, 2.iv.1987, M. Kruger (NCA, 88/326); 1♂ same locality, Ditsong National Museum of Natural History, 25°44'S 28°11'E, in building, 1.vi.1973, N.J. Dippenaar (NCA, 76/685); 1♂ same locality, Hatfield, University of Pretoria, 25°44'S 28°14'E, in building, 22.iv.1987, C. du Plessis (NCA, 88/308); 1♀ same locality, Pretoria North, 25°44'S 28°11'E, by hand, 11.ii.1987, H. Joubert (NCA, 88/515); 1♂ same locality, Pretoria West, 25°49'S 28°18'E, grass, 29.iv.1987, M. Stebbe (NCA, 88/365); 1♂ same locality, Queenswood, 25°43'S 28°15'E, in building, 11.xi.1975, L. Harley (NCA, 76/1570). *KwaZulu-Natal*: 1♀ Empangeni, University of Zululand, 28°45'S 31°45'E, 75 m, 5.iv.1984, P.E. Reavell (NMSA, 26495); 1♂ iSimangaliso Wetlands Park, Kosi Bay Nature Reserve, 26°55'S 32°52'E, in house, 4.iv.1981, A. Tuffin (NCA, 86/101); 1♀ Tembe Elephant Park, near Mahlasela Hide, 27°02.777'S 32°26.900'E, closed woodland/sand, beating, 6.i.2002, C. Haddad, (NCA, 2007/3255). *Limpopo*: 1♀ Kruger National Park, Letaba, 23°49'S 31°34'E, by hand, 15.viii.2008, K. Geldenhuys (NCA, 2010/2335); 1♀ same data (NCA, 2010/2336). *North West*: 1♀ Rustenburg, 25°39'S 27°13'E, by hand, 4.iv.1987, H. Uys (NCA, 88/369). *Northern Cape*: 1♂ Augrabies National Park, 28°39'S 20°25'E, by hand, 4.vi.1996, M. de Jager (NCA, 96/425).



Fig. 71. Distribution of *Habrocestum africanum* (black circles), *H. albimanum* (white circles) and *Hasarius adansoni* (black stars) in South Africa.

Distribution: A widespread cosmopolitan species, recorded from South Africa for the first time, where it has been collected from most of the provinces (Fig. 71).

Habitat and biology: A very adaptable synanthropic species collected from foliage and leaf-litter in natural habitats, but also regularly collected in South Africa from buildings.

Remarks: Because of its cosmopolitan distribution, this is one of the salticids with the most extensive literature bibliographies, and it has been described under at least 25 synonymous names (Prószyński & Deeleman-Reinhold 2010) and treated in 38 publications (Platnick 2012). Only literature pertinent to the Afrotropical Region has been cited here; for a full bibliography see Platnick (2012).

Genus *Heliophanus* C.L. Koch, 1833

Heliophanus (Heliocapensis) aberdarensis Wesolowska, 1986

Figs 72–79

Heliophanus aberdarensis: Wesolowska 1986: 224, figs 793, 794.

Diagnosis: The species resembles other members of the subgenus *Heliocapensis*. The male is distinguished by the shape of the tibial apophysis, which is forked, somewhat like that in *Heliophanus portentosus* Wesolowska, 1986 from the Western Cape, but clearly smaller; *H. portentosus* also has an additional long retrolateral apophysis, which is absent in *H. aberdarensis*. The female is distinctive in having a large square deep epigynal depression, which is unlike the epigyne of any other species in the genus.

Redescription:

Measurements ($\delta/\text{♀}$). Cephalothorax: length 1.7–1.8/1.2, width 1.2–1.3/1.3, height 0.6/0.7. Abdomen: length 1.9–2.0/2.5, width 1.2–1.3/1.3. Eye field: length 0.7/0.7, anterior width 0.9–1.0/1.0, posterior width 1.0–1.1/1.1.

Male.

Small, darkly coloured spider. Carapace dark brown with metallic lustre, eye field black, pitted; delicate brown hairs present on carapace dorsum, with some longer bristles near anterior eyes. Mouthparts and sternum brown, only endites slightly paler. Abdomen brown, clothed in sparse delicate brown hairs, with some white scales near anterior edge; venter faint brown. Legs and pedipalps brown, pedipalps ornamented with white scales along median line dorsally (Fig. 76). Palpal tibial apophysis forked, embolus short and curved (Figs 72–75); femur with small process on ventral surface (Fig. 77).

Female.

Similar to male, colouration darker, almost black. Whole body clothed in short dense light grey hairs. Abdomen with two whitish rounded spots ventrally at base of spinnerets. Legs and pedipalps brownish orange. Epigyne with large square depression, plugged with waxy secretion (Fig. 78). Internal structure as in Fig. 79.

Material examined: SOUTH AFRICA: *Gauteng*: 2♂ 1♀ Suikerbosrand Nature Reserve, near Heidelberg, 26°30'S 28°15'E, sweeping in grass, 23.iii.1979, A. Leroy & A. Jordan (NCA, 79/206).

Distribution: A species previously known only from the type locality in Kenya, recorded for the first time from South Africa (Fig. 86).

Habitat and biology: Collected by sweep-netting in grassland.

Remarks: The male is described here for the first time. Discovery of this sex and study of the palpal structure makes it possible to include the species in the subgenus *Helio-capensis*.

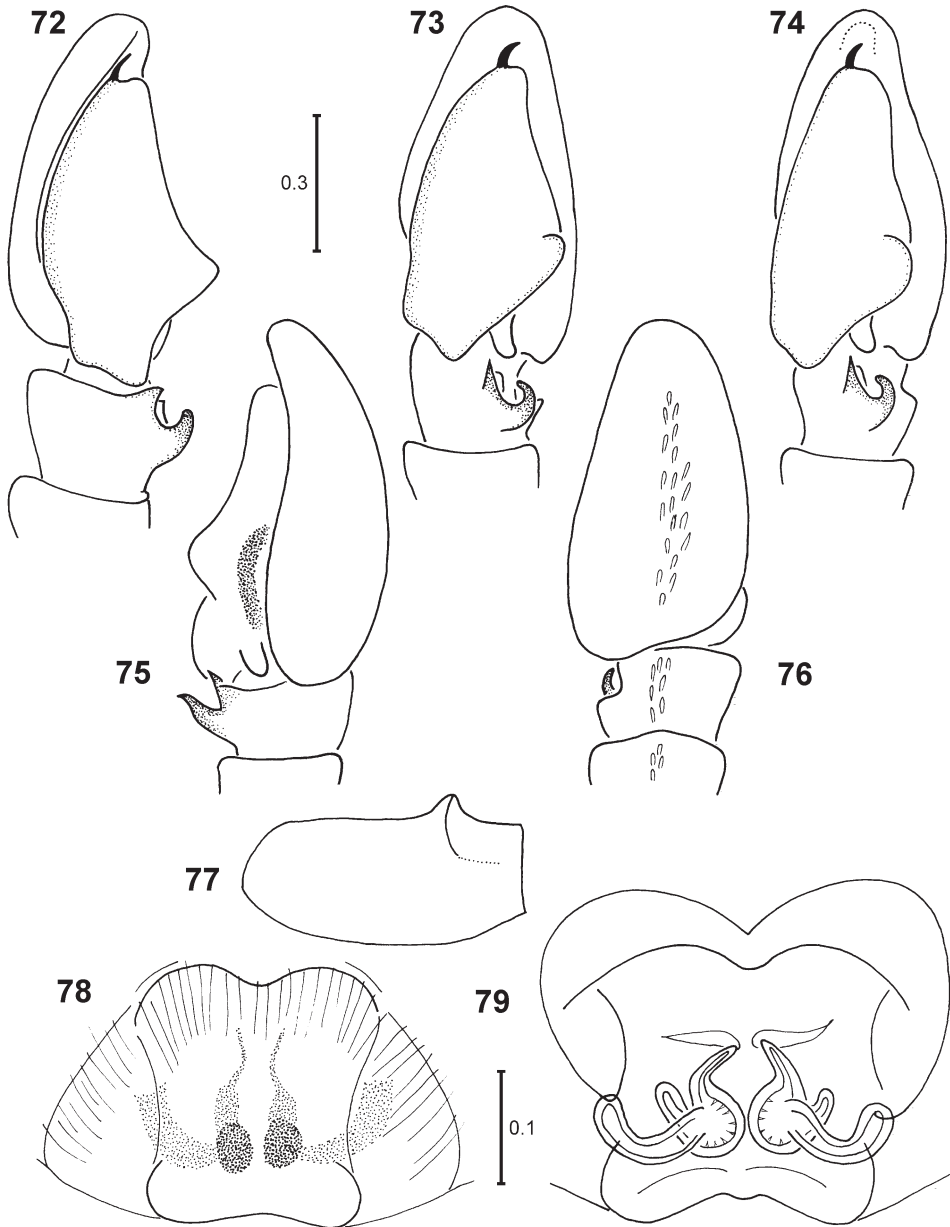

Figs 72–79. *Heliophanus aberdarensis*, ♂ (72–77) and ♀ (78, 79): (72) palpal organ, prolateral-ventral view; (73) same, ventral view; (74) same, retrolateral-ventral view; (75) same, lateral view; (76) same, dorsal view; (77) palpal femur; (78) epigyne, ventral view; (79) internal structure of epigyne.

Heliophanus (Heliophanus) gramineus sp. n.

Figs 11, 80, 81

Etymology: From Latin *gramineus* (of, or belonging to, grass), in reference to habitat of the species.

Diagnosis: The female is easily distinguished from congeners by the colouration of the abdomen: generally greyish beige with a darker pattern, whereas other species are dark, often black, sometimes with lighter patches. The form of the epigyne, with a very deep and broad excavation, is also characteristic. Male unknown.

Description:

Female.

Measurements. Cephalothorax: length 1.5–1.6, width 1.3–1.4, height 0.6. Abdomen: length 2.4–2.9, width 2.1–2.4. Eye field: length 0.7, anterior width 0.9–1.0, posterior width 1.0–1.1.

General appearance as in Fig. 11. Shape of carapace typical for members of the genus, slightly broader posteriorly, moderately high, with prominent flat area; carapace dark brown with black rings surrounding eyes, clothed in dense greyish hairs, with sparse long bristles scattered between them. Chelicerae unidentate. Mouthparts dark. Abdomen very swollen, almost globular, greyish beige with brown pattern consisting of median chain of triangular spots accompanied by submarginal spots (Fig. 11). Venter brownish beige, with pale median band in anterior half and two marginal spots placed posteriorly. Spinnerets yellowish grey. Legs greyish beige, ornamented with black rings at bases and tips of patellae, and tips of tibiae; femora with blackish line along prolateral surfaces. Pedipalps yellow. Epigyne wide, with small pocket at posterior edge. Centre of epigyne occupied by very large, broad, deep excavation (Fig. 80), plugged with waxy secretion. Internal structure as in Fig. 81.

Holotype: ♀ SOUTH AFRICA: *Eastern Cape*: Amatola Mtns, Hogsback, 39 Steps waterfall, 32°35.386'S 26°55.985'E, 1250 m, base of grass tussocks, 6.i.2011, C. Haddad (NCA, 2012/1102).

Paratypes: SOUTH AFRICA: *Eastern Cape*: 1♀ together with holotype (NCA, 2012/1102); 1♀ same locality, Amatola Forestry Company offices, 32°35.276'S 26°55.911'E, 1270 m, sweeps, fynbos in wetland, 2.iv.2011, C. Haddad, J. Neethling & A. van Rooyen (NMSA, 26405); 1♀ same data but 22.iv.2012, C. Haddad (NMBA); 1♀ Amatola Mtns, Katberg State Forest, 32°28.137'S 26°40.276'E, 1350 m, base of grass tussocks, 8.i.2011, C. Haddad (NCA, 2012/1100).

Distribution: Known only from two localities in the Amatola Mountains, Eastern Cape Province (Fig. 86).

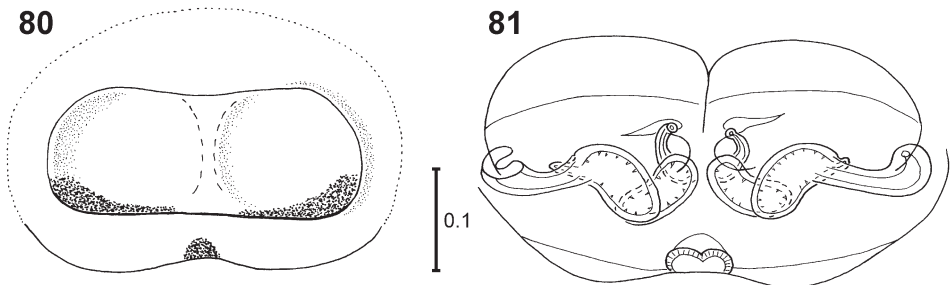

Figs 80, 81. *Heliophanus gramineus* sp. n., paratype ♀: (80) epigyne, ventral view; (81) internal structure of epigyne.

Habitat and biology: The known specimens were all collected at the base of grass tussocks in grassland and fynbos habitats surrounded by Afromontane forests.

Remarks: The subgeneric placement of this species, as well as the species group within the subgenus, should be clarified when the male is discovered, as the female epigyne lacks adequate distinctive characteristics for a certain placement.

***Heliophanus (Heliophanus) ndumoensis* sp. n.**

Figs 12, 82–85

Etymology: From Ndumo Game Reserve, where the holotype was collected.

Diagnosis: This species is closely related to *Heliophanus harpago* Simon, 1909 from tropical Africa, but the palp has a shorter embolus and a triangular-shaped bulb (square in *H. harpago*). Female unknown.

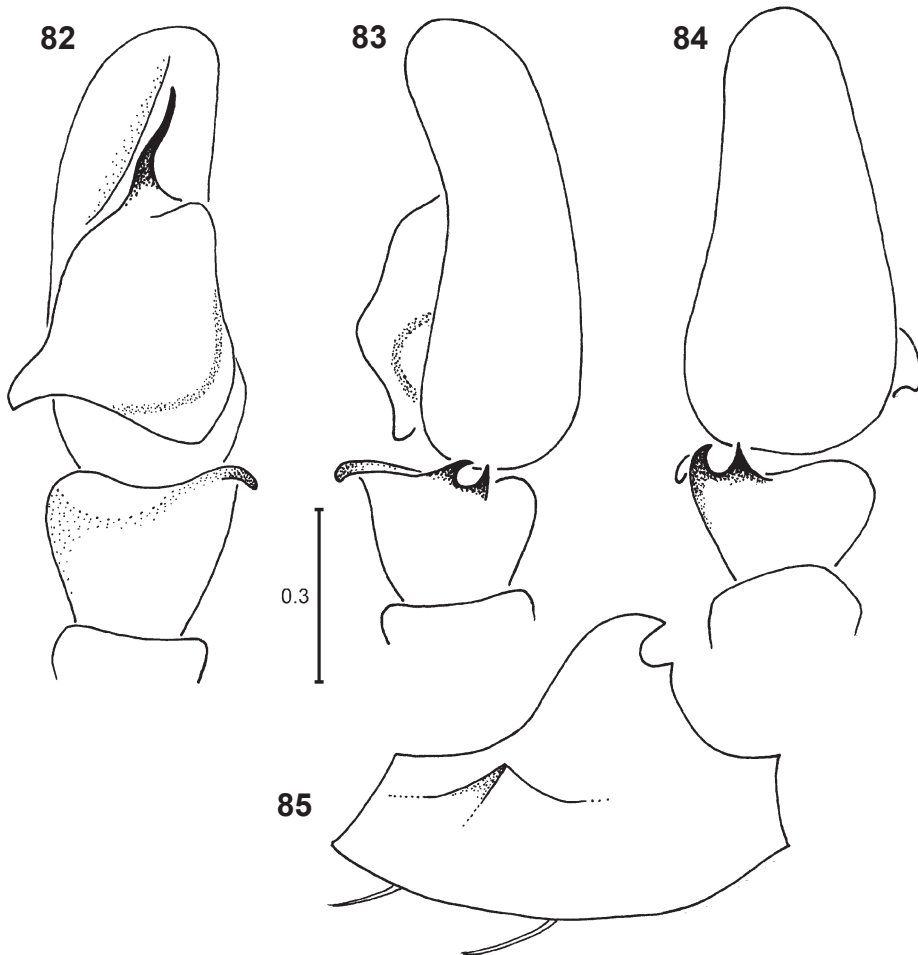

Figs 82–85. *Heliophanus ndumoensis* sp. n., holotype ♂: (82) palpal organ, ventral view; (83) same, lateral view; (84) same, dorsal view; (85) palpal femur.

Description:

Male.

Measurements. Cephalothorax: length 2.6, width 2.2, height 1.1. Abdomen: length 2.4, width 1.8. Eye field: length 1.0, anterior width 1.5, posterior width 1.6.

General appearance as in Fig. 12. Medium sized spider. Carapace oval with prominent flat area, moderately high, brown, eye field black; short brownish grey hairs cover carapace, with scattered long bristles among them, denser at anterior eyes; clypeus very low, some light scales below anterior lateral eyes on “cheeks”. Mouthparts and sternum dark brown. Abdomen smaller than carapace, ovoid, greyish fawn, clothed in short, generally dark brownish grey hairs, with long dense brown bristles on anterior edge. Venter dark. Spinnerets greyish brown. Legs brownish fawn, first pair longer and thicker than others, with dark brown femora. Tibiae of first pair with three pairs of ventral spines, metatarsi with two pairs. Pedipalps with large femoral apophysis, with notch (Fig. 85); cymbium narrow, bulb triangular, with small ventrolateral apophysis and pincer-shaped retrolateral apophysis (Figs 82–84).

Holotype: ♂ SOUTH AFRICA: *KwaZulu-Natal*: Ndumo Game Reserve, southern boundary fence, 26°55.664'S 32°19.038'E, sand forest, leaf-litter, 7.xii.2009, C. Haddad (NMBA).

Distribution: Only known from the type locality (Fig. 86).

Habitat and biology: This species was collected in leaf-litter in a small patch of sand forest. Its colouration apparently provides some degree of crypsis in the litter layer.

Remarks: The species belongs to the *orchesta* group of species (Wesołowska 1986).



Fig. 86. Distribution of *Heliophanus aberdarensis* (white circle), *H. gramineus* sp. n. (black circles), *H. ndumoensis* sp. n. (white square), *H. pygmaeus* (black squares), *Langelurillus krugeri* sp. n. (white star) and *Langona tortuosa* (black star) in South Africa.

Heliophanus (Heliophanus) pygmaeus Wesolowska & Russell-Smith, 2000

Heliophanus pygmaeus: Wesolowska & Russell-Smith 2000: 36, figs 73–76; Wesolowska 2004: 277, figs 1–13; Wesolowska & Cumming 2008: 184, figs 50, 51.

Xuriella prima: Wesolowska & Russell-Smith 2000: 115, figs 322–325 (♀ misidentified).

Wesolowska & Cumming (2008) described both sexes.

Material examined: SOUTH AFRICA: *Mpumalanga*: 1♀ Kruger National Park, Satara, N'wanetsi, 24°26.940'S 31°51.060'E, sweepnetting, iii.2008, B. Reynolds (NCA, 2010/2739); 1♂ same data but 24°26.700'S 31°51.340'E (NCA, 2010/2740); 1♀ same locality, Pretoriuskop, Shabeni, 25°06.420'S 31°13.920'E, sweepnetting, iv.2008, B. Reynolds (NCA, 2010/2738); 1♀ same locality, Pretoriuskop, Kambeni, 25°09.240'S 31°16.260'E, litter sifting, ix–x.2008, B. Reynolds (NCA, 2010/2737).

Distribution: Species known from Tanzania and Zimbabwe, recorded for the first time from South Africa (Fig. 86).

Habitat and biology: This species can be regarded as a beetle-mimicking spider and somewhat resembles small black ladybirds (Coleoptera: Coccinellidae) in general appearance and size. All of the material was collected close to the ground in leaf-litter, or sweeping grass in savanna woodlands.

Genus *Langelurillus* Próchniewicz, 1994***Langelurillus krugeri* sp. n.**

Figs 87, 88

Etymology: The species name is a patronym for Paul Kruger, former president of the South African Republic, after whom the type locality is named.

Diagnosis: The species may be distinguished by the very wide and low epigyne. The internal structure is slightly similar to that in *Langelurillus primus* Próchniewicz, 1994 from Kenya, but differs having shorter seminal ducts and the spermathecae placed perpendicularly to the epigastric furrow (parallel in *L. primus*). Male unknown.

Description:

Female.

Measurements. Cephalothorax: length 1.9, width 1.6, height 0.9. Abdomen: length 2.9, width 2.6. Eye field: length 0.7, anterior width 1.1, posterior width 1.2.

Carapace high, with very steep posterior thoracic slope, pear-shaped, widest at coxae III. Colouration of carapace blackish, dorsum covered with diminutive hairs adpressed to surface, with numerous long brown bristles on anterior part of eye field. Clypeus moderately high, dark, with long dark bristles. Chelicerae toothless. Mouthparts and sternum

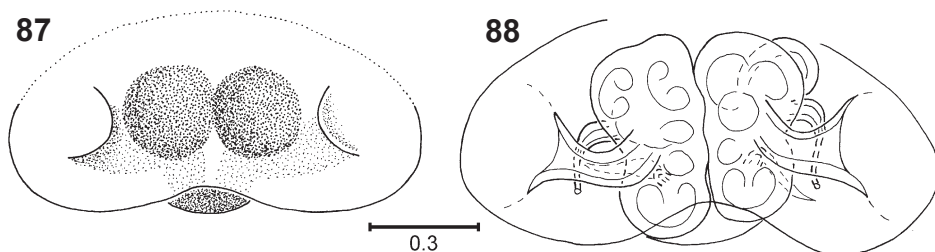

Figs 87, 88. *Langelurillus krugeri* sp. n., holotype ♀: (87) epigyne, ventral view; (88) internal structure of epigyne.

dark. Abdomen large, rounded, slightly swollen, brownish grey with ill-defined lighter patches; clothed in brown hairs, with scattered long brown bristles, denser anteriorly. Venter dark. Spinnerets yellowish grey. Legs yellowish, bases and tips of segments darker, all femora dark. Leg III longest, especially femora, but leg segments generally rather short. Leg hairs brown. Spines numerous, brown. Epigyne low and wide, with two rounded depressions laterally (Fig. 87). Seminal ducts short; spermathecae strongly sclerotized, multi-chambered; accessory glands long (Fig. 88).

Holotype: ♀ SOUTH AFRICA: *Limpopo*: Kruger National Park, Mopani, Tsendze, 23°41.460'S 31°31.080'E, active searching, i.2009, B. Reynolds (NCA, 2010/2736).

Distribution: Known only from the type locality (Fig. 86).

Habitat and biology: A ground-dwelling spider from savanna woodland.

Genus *Langona* Simon, 1901
Langona tortuosa Wesolowska, 2011

Langona tortuosa: Wesolowska 2011: 330, figs 56–60.

Wesolowska (2011) described both sexes.

Material examined: SOUTH AFRICA: *Mpumalanga*: 1♂ Kruger National Park, Satara, N'wanetsi, 24°26.700'S 31°53.340'E, ii.2009, B. Reynolds (NCA, 2010/2735).

Distribution: Known from Namibia and Zimbabwe, now recorded in South Africa for the first time (Fig. 86).

Habitat and biology: A ground-dwelling spider that is apparently widespread in moist and dry savannas in southern Africa.

Genus *Massagris* Simon, 1900
***Massagris contortuplicata* sp. n.**

Figs 89, 103–106

Massagris cf. *honesta* Wesolowska, 1993; Maddison & Needham 2006: 49, fig. 12 (♀).

Etymology: From Latin *contortuplicata* (writhed about in many folds), in reference to the complex structure of the epigyne.

Diagnosis: The females of several *Massagris* species remain unknown, and only the female of *M. honesta* Wesolowska, 1993 has been previously described (see below for redescription). The female of the new species is recognizable by the long seminal ducts forming several loops, which are clearly shorter in *M. honesta*. Male unknown.

Description:

Female.

Measurements. Cephalothorax: length 2.5, width 1.5, height 1.0. Abdomen: length 2.5, width 1.8. Eye field: length 1.4, anterior width 1.3, posterior width 1.2.

General appearance in Fig. 89. Carapace oval, moderately high, gently sloping posteriorly; eye field occupies half of carapace length, eyes set on well-developed tubercles (Fig. 103); carapace brown, vicinity of eyes black, ocular area transparent with silver spots of internal guanine crystals. Fovea long, sulciform. Clypeus low and brown, with some whitish hairs. Labium, endites and sternum yellow. Chelicerae pluridentate, both margins with several small teeth (Fig. 104). Abdomen oval, greyish yellow, with small

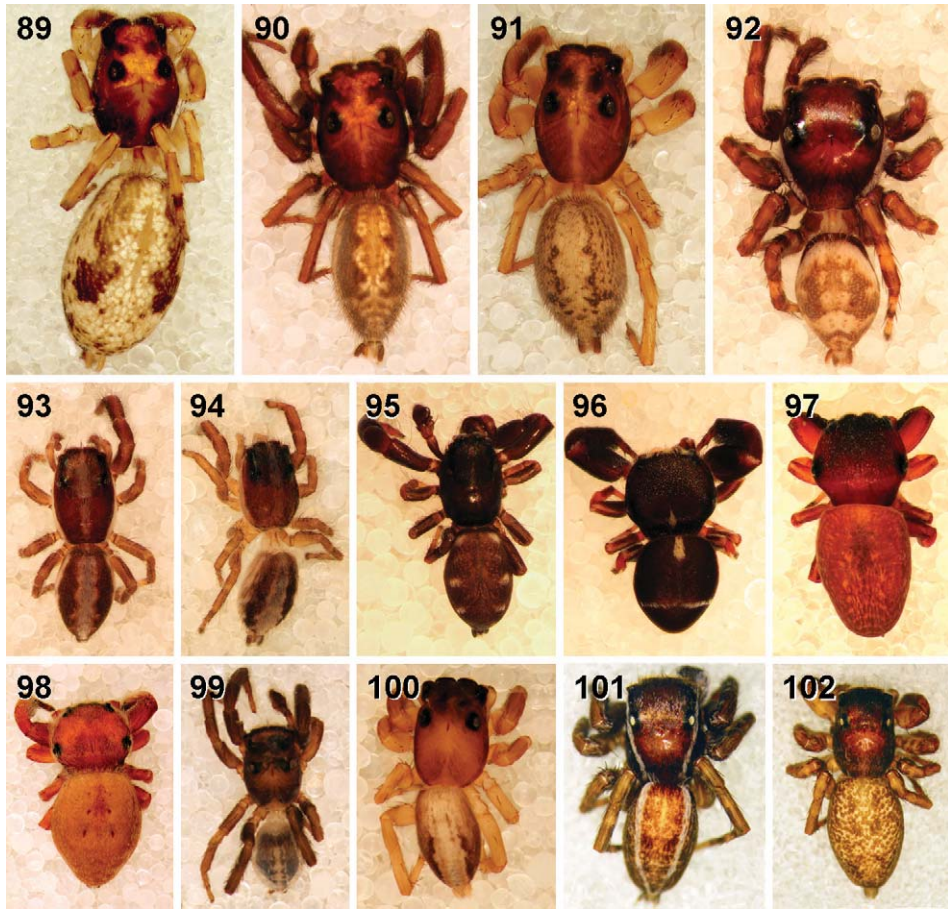

Figs 89–102. Digital microscope photographs of the dorsal habitus of South African jumping spiders: (89) *Massagris contortuplicata* sp. n., ♀; (90, 91) *M. honesta*, ♂ (90) and ♀ (91); (92) *Pignus pongola*, ♂; (93, 94) *Pseudiclus africanus*, ♂ (93) and ♀ (94); (95) *P. imitator* sp. n., ♂; (96, 97) *Rhene facilis*, ♂ (96) and ♀ (97); (98) *R. timidus* sp. n., ♂; (99, 100) *Tomomingi szutsi* sp. n., ♂ (99) and ♀ (100); (101, 102) *Ureta quadrispinosa*, ♂ (101) and ♀ (102).

brown spots; silver guanine crystals translucent through integument; venter identically coloured. Spinnerets and legs yellow. Epigyne with two widely separate rounded depressions (Fig. 105). Copulatory openings placed in deep atria; seminal ducts long, forming several loops (Fig. 106).

Holotype: ♀ SOUTH AFRICA: *Eastern Cape*: Amatola Mtns, Hogsback, 32°35.649'S 26°56.638'E, Afro-montane forest, beating shrubs, 9.iv.2010, University of the Free State students (NCA, 2012/1097).

Paratypes: SOUTH AFRICA: *Eastern Cape*: 1 ♀ together with holotype (NCA, 2012/1097); 1 ♀ same locality, 32°35.987'S 26°55.880'E, 1140 m, Afro-montane forest, canopy fogging *Xymalos monospora*, 3.iv.2012, C. Haddad, J. Neethling, A. van Rooyen & R. du Preez (NMSA, 26418); 1 ♀ Kei Mouth, 32°41'S 28°22'E, coastal dune forest, leaf-litter, 6.xii.2005, C. Haddad (NMBA).

Distribution: Known only from two localities in south-eastern South Africa (Fig. 114).

Habitat and biology: This species has been collected in the upper and lower habitat strata of Afro-montane and coastal forests.

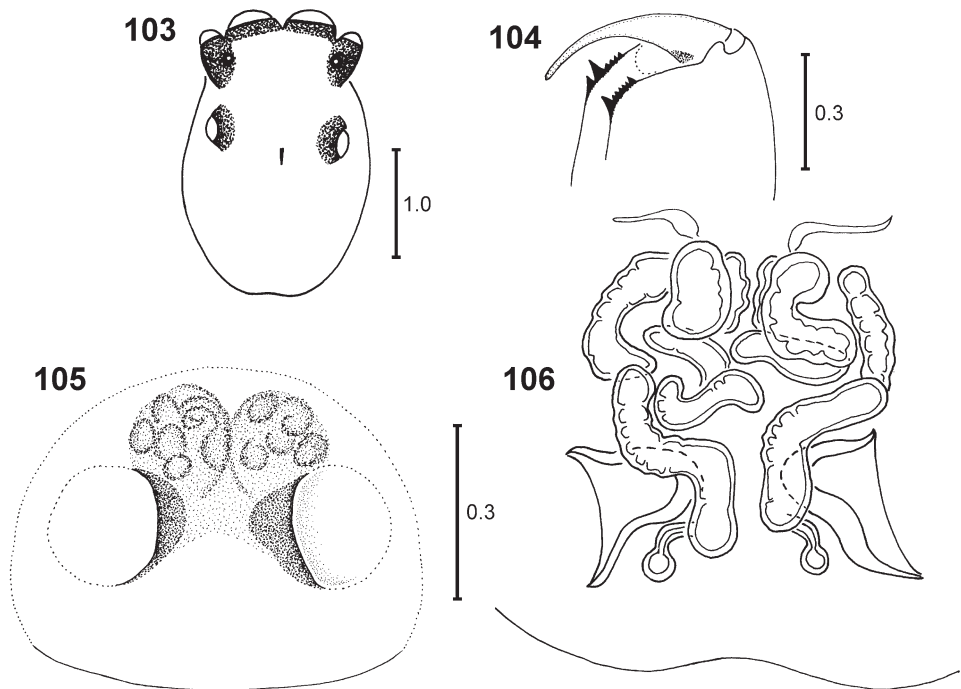

Figs 103–106. *Massagris contortuplicata* sp. n., paratype ♀: (103) carapace, dorsal view; (104) cheliceral dentition; (105) epigyne, ventral view; (106) internal structure of epigyne.

Remarks: This species was included in the phylogenetic analysis of Maddison and Needham (2006), wherein they referred to it as *Massagris* cf. *honesta* Wesolowska, 1993 and indicated that it was likely to be new. They also included an illustration of the female epigyne (Maddison & Needham 2006: 49, fig. 12), which conforms to the figure included in the description of the species here.

Massagris honesta Wesolowska, 1993

Figs 19, 90, 91, 107–113

Massagris honesta: Wesolowska 1993: 140, figs 18–20.

Massagris regina: Wesolowska 1993: 138, figs 15–17. **Syn. n.**

Wesolowska (1993) described both sexes; general appearance of male as in Figs 19 & 90, female as in Fig. 91; male cheliceral dentition as in Fig. 107, first leg as in Fig. 108; structure of copulatory organs as in Figs 109–113.

Material examined: SOUTH AFRICA: *Eastern Cape*: 1 ♀ Amatola Mtns, Hogsback, 32°36.285'S 26°56.580'E, active searching, 27.iii.2007, C. Haddad (NCA, 2007/1209); 1 ♂ same locality, Amatola Forestry Company Offices, 32°35.276'S 26°55.911'E, 1270 m, under overhanging vegetation, 22.iv.2012, C. Haddad (NMBA). *Western Cape*: 2 ♂ 1 ♀ De Hoop Nature Reserve, Lekkerwater road, 34°24.023'S 20°33.189'E, under *Thamnochortis restios*, 26.iii.2005, C. Haddad (NMBA); 1 ♂ same locality, De Hoop Vlei, 34°29.425'S 20°25.762'E, under rocks, 25.iii.2005, C. Haddad (NMBA); 1 ♀ same locality, Koppie Alleen, 34°28.534'S 20°30.349'E, rocky shore, retreats in intertidal zone, 10.iv.2004, C. Haddad (NMBA); 6 ♀ same locality, Potberg, 34°22.487'S 20°31.980'E, *Eucalyptus* forest, leaf-litter, 4.iv.2004, C. Haddad (NMBA); 2 ♂ 2 ♀ Grootvadersbosch Forest Station, 20 km WNW of Heidelberg, 34°00'S 20°47'E, 1600 ft, indigenous forest, 8–10.xi.1985, C. Griswold, J. Doyen & T. Meikle-Griswold (NMSA, 26454).

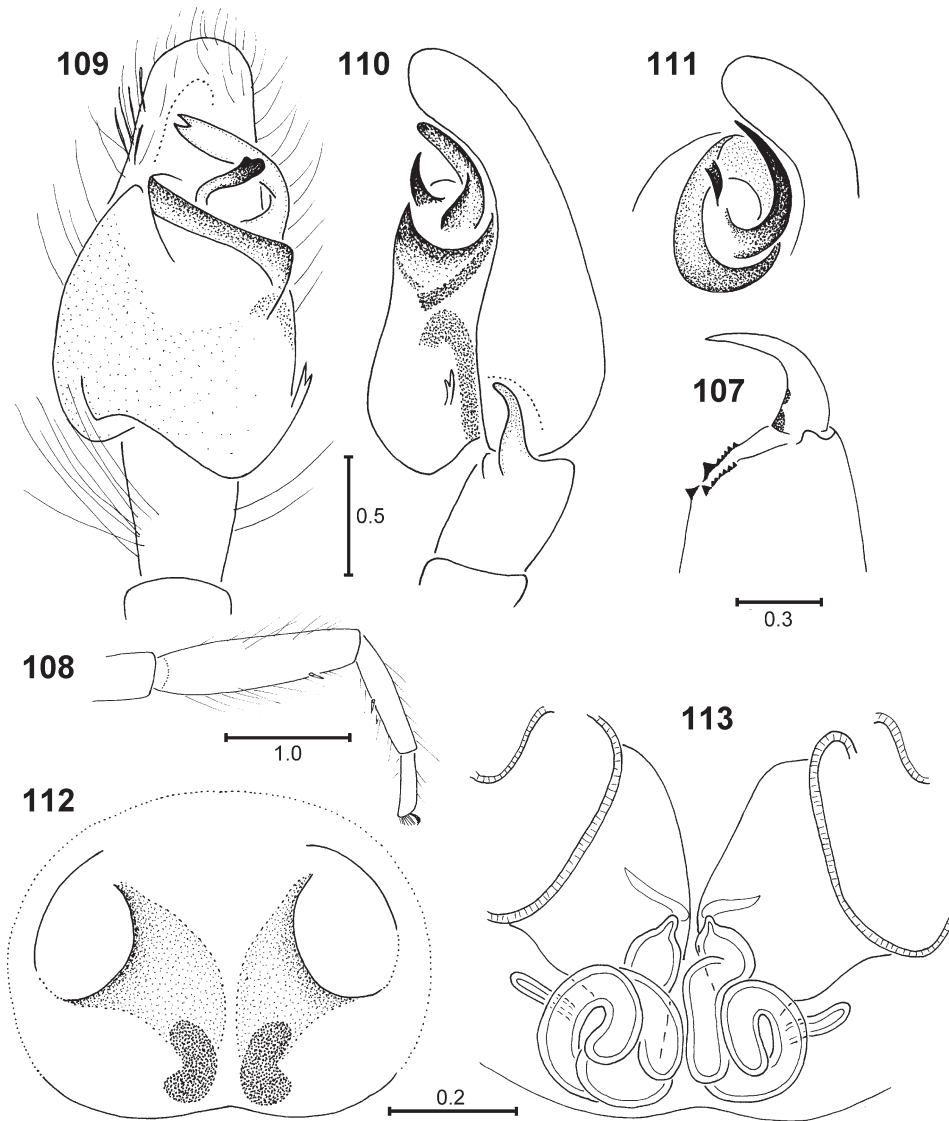

Figs 107–113. *Massagris honesta*, ♂ (107–111) and ♀ (112, 113): (107) cheliceral dentition; (108) first leg; (109) palpal organ, ventral view; (110) same, lateral view; (111) embolic division, lateroapical view; (112) epigyne, ventral view; (113) internal structure of epigyne.

Distribution: Species previously known only from the vicinity of Cape Town, in the Western Cape Province of South Africa only (Fig. 114); recorded here for the first time from the Eastern Cape.

Habitat and biology: Based on published records (Wesołowska 1993) and the new records presented above, it seems as if *M. honesta* is endemic to the Fynbos and Forest biomes in southern South Africa. Specimens were collected from leaf-litter and low-growing vegetation.

Remarks: *M. honesta* was originally described from the male only and *M. regina* from the female only. Both males and females were collected together at De Hoop Nature Reserve, enabling us to recognize these species as synonyms.

Genus *Mogrus* Simon, 1882
Mogrus mathisi (Berland & Millot, 1941)

Fig. 20

Phlaeus mathisi: Berland & Millot 1941: 341, fig. 46.

Phlaeus senilis: Denis 1955: 126, figs 26–28.

Mogrus dillae: Prószyński 1989: 40, figs 18–20; Wesołowska & van Harten 1994: 56, figs 115, 116; Wesołowska & Russell-Smith 2000: 70, figs 185–187.

Mogrus mathisi: Wesołowska 2003: 426, figs 1–10; 2011: 333; Logunov 2004: 88; Wesołowska & van Harten 2007: 235, figs 131–134; Wesołowska & Tomasiewicz 2008: 28.

Wesołowska (2003) described both sexes; male chelicerae clothed in dense white hairs, contrasting with the dark colouration of the carapace (Fig. 20).

Material examined: SOUTH AFRICA: *Free State*: 3♂ 1♀ Amanzi Private Game Reserve, 28°35.558'S 26°26.032'E, 1427 m, grassland, canopy fogging *Acacia karroo*, 25.xii.2010, V. Butler (NCA, 2011/915).

Distribution: Species widely distributed in Africa and the Middle East, recorded from South Africa for the first time here (Fig. 114).

Habitat and biology: The record presented here is derived from fogging a sweet-thorn (*Acacia karroo* tree) in open grassland.



Fig. 114. Distribution of *Massagrís contortuplicata* sp. n. (white circles), *M. honesta* (black circles), *Mogrus mathisi* (white square) and *Pignus pongola* (black squares) in South Africa.

Genus *Pignus* Wesolowska, 2000
Pignus pongola Wesolowska & Haddad, 2009

Fig. 92

Pignus pongola: Wesolowska & Haddad 2009: 73, figs 147–151.

Wesolowska & Haddad (2009) described the male, general appearance as in Fig. 92 (female unknown).

Material examined: SOUTH AFRICA: *KwaZulu-Natal*: 1 ♂ iSimangaliso Wetlands Park, St Lucia, 28°23.072'S 32°24.400'E, 22 m, coastal forest, canopy fogging *Trichilia emetica*, 13.v.2012, J. Neethling & C. Luwes (NMSA, 26453); 1 ♂ Tembe Elephant Park, 27°03'S 32°25'E, iii.2003, A. Honiball & S. Otto (NCA, 2006/1287). *Western Cape*: 1 ♂ De Hoop Nature Reserve, Potberg, 34°22.719'S 20°32.216'E, sifting leaf-litter, transition between *Eucalyptus* plantation and fynbos, 24.iii.2005, C. Haddad (NMBA).

Distribution: Species previously known only from the type locality (Ndumo Game Reserve); two additional records from northern KwaZulu-Natal are added here, as well as the first records from the Western Cape Province (Fig. 114).

Habitat and biology: Known only from forest habitats and fynbos.

Genus *Pseudicius* Simon, 1885
Pseudicius africanus Peckham & Peckham, 1903

Figs 93, 94, 115–118

Pseudicius africanus: Peckham & Peckham 1903: 212, pl. 26, figs 2–2a.

Diagnosis: The species is closely related to *Pseudicius maculatus* Haddad & Wesolowska, 2011, but can be recognised by the abdominal pattern, which comprises a light median band in *P. africanus* as opposed to spotted in *P. maculatus*. Males of both species have a very similar palpal organ, but in *P. africanus* the embolus is slightly shorter and the tibial apophysis has an additional ventral tooth. Females differ in the position of the copulatory openings, which are placed in the edge of the epigynal depression in *P. africanus* but posteriorly within a deep pocket in *P. maculatus* (see Haddad & Wesolowska 2011: fig. 198).

Redescription:

Measurements (♂/♀). Cephalothorax: length 2.5/2.0, width 1.5/1.3, height 1.0/0.8. Abdomen: length 2.5/2.2, width 1.8/1.3. Eye field: length 1.4/0.8, anterior width 1.3/1.0, posterior width 1.2/1.1.

Male.

General appearance as in Fig. 93. Small spider with slender, flattened body; carapace oval, dark brown, with darker eye field; eyes encircled by black rings, with brown bristles near eyes. White hairs form thin median band starting from anterior median eyes to posterior edge of carapace. Clypeus low, clothed in white hairs; stripes composed of white hairs extending along lateral margins of carapace. Stridulatory apparatus present. Mouthparts and sternum dark brown. Abdomen ovoid, slightly elongated, dark brown, with median broad streak composed of whitish hairs; sides of abdomen with white stripe running from anterior to spinnerets. Venter grey, with two pale lines. Anterior spinnerets dark, posteriors paler. Legs brown, first pair darker, stouter and longer than others. Leg hairs and spines brown. Pedipalp brown; tibial apophysis broad, with additional ventral tooth (Figs 115, 116); embolus curved towards retrolateral margin of cymbium (Fig. 115).

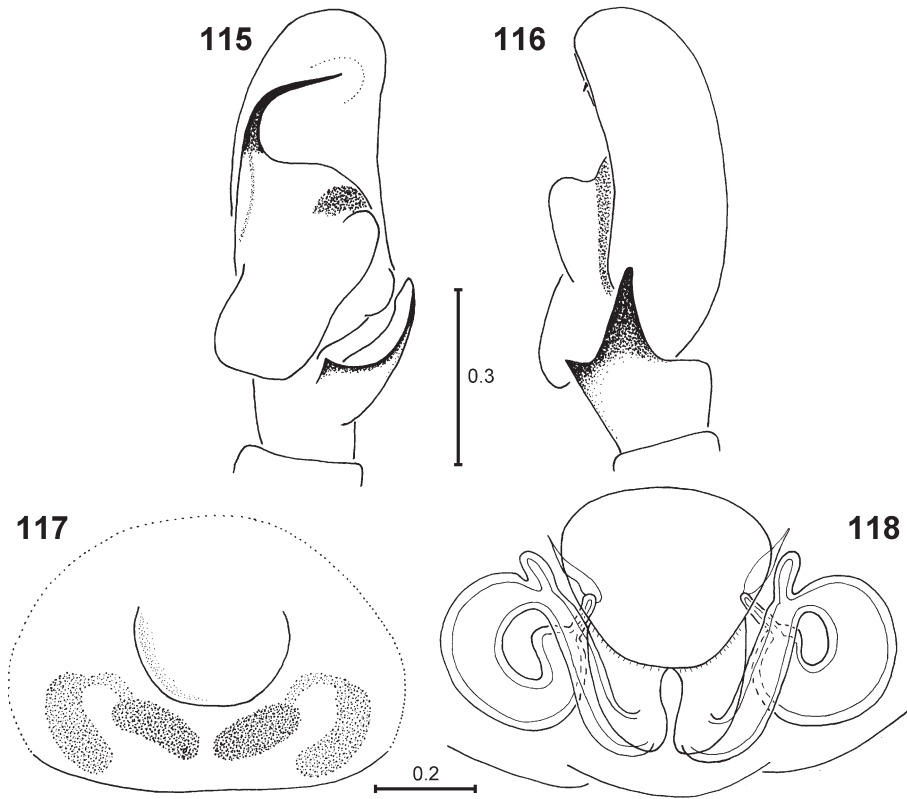

Figs 115–118. *Pseudicius africanus*, ♂ (115, 116) and ♀ (117, 118): (115) palpal organ, ventral view; (116) same, lateral view; (117) epigyne, ventral view; (118) internal structure of epigyne.

Female.

Shape of body and colouration as in male, general appearance as in Fig. 94. All legs pale brown, first pair similarly thick as others (not stouter as in male). Epigyne with large central depression (Fig. 117), with copulatory openings placed on posterior margin of the depression. Internal structure as in Fig. 118.

Material examined: SOUTH AFRICA: *Western Cape*: 1 imm. 1♂ 1♀ De Hoop Nature Reserve, Potberg, 34°22'S 20°32'E, *Eucalyptus* forest, beating shrub foliage, 4.iv.2004, C. Haddad (NMBA); 1 imm. 1♂ same locality, De Hoop Vlei, 34°29.425'S 20°25.762'E, under rocks, 8.iv.2004, C. Haddad (NMBA).

Distribution: Western Cape Province (Fig. 139); originally described from the “Cape Colony”, presumably in the vicinity of Cape Town (33°55'S 18°25'E).

Habitat and biology: A foliage-dwelling spider collected in fynbos habitats.

Remarks: The male is described here for the first time.

***Pseudicius dentatus* sp. n.**

Figs 119–124

Etymology: From Latin *dentatus* (toothed), in reference to the distinct series of denticles on the male palpal tibial apophysis.

Diagnosis: This species is closely related to *Pseudicius dependens* Haddad & Wesołowska, 2011 from central South Africa. The male is easily distinguished by the clearly broader embolus and the absence of a curved tegular lobe. The shape of the pedipalp tibial apophysis is also distinct. In the retrolateral view of the palp it is flabellate with a serrated end comprising many distinct denticles and a smaller lobe on its dorsal surface, whereas in *P. dependens* it is narrowed towards the bifid tip, has smaller denticles and lacks a

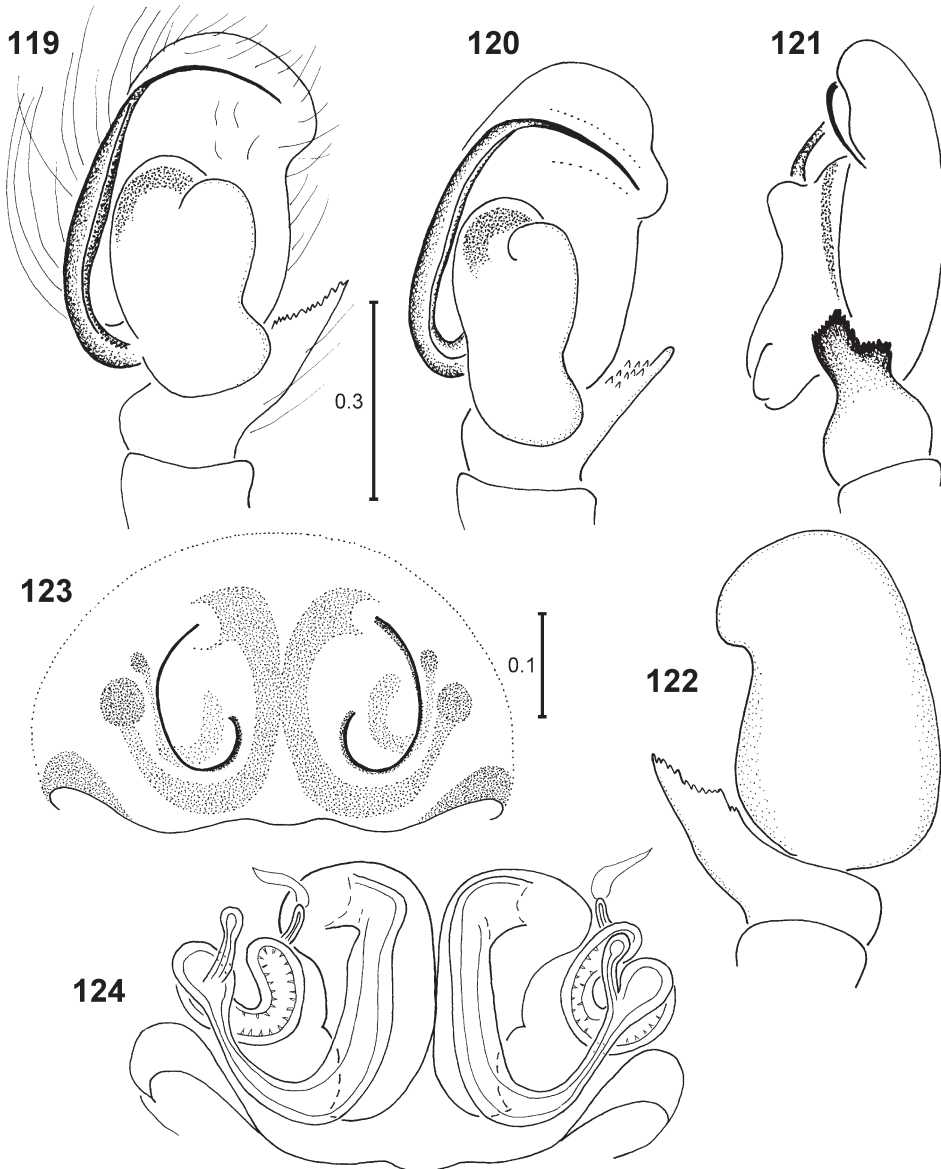

Figs 119–124. *Pseudicius dentatus* sp. n., paratype ♂ (119–122) and paratype ♀ (123, 124): (119) palpal organ, ventral view; (120) same, ventrolateral view; (121) same, lateral view; (122) same, dorsal view; (123) epigyne, ventral view; (124) internal structure of epigyne.

dorsal lobe (see Haddad & Wesolowska 2011: figs 166, 167). The female differs by the presence of epigynal pockets (absent in *P. dependens*) and the position of the gonopores (low, at epigastric furrow in the new species, versus central in *P. dependens*).

Description:

Measurements (♂/♀). Cephalothorax: length 1.7–1.8/1.7–2.0, width 1.1–1.2/1.1–1.4, height 0.6/0.6. Abdomen: length 1.7–2.1/2.3–2.9, width 1.0–1.2/1.3–1.5. Eye field: length 0.7–0.8/0.7–0.8, anterior width 0.9–1.0/0.9–1.1, posterior width 1.0–1.1/1.0–1.2.

Male.

Small spider with slender and flattened body. Carapace oval, chocolate brown, with black line along margins; white hairs forming streak on sides, extending onto clypeus. Eyes surrounded with black rings; eye field pitted, some white hairs on it, with long brown bristles near eyes; anterior median eyes encircled by small fawn scales. Stridulatory apparatus present. Chelicerae unidentate, retromarginal tooth large. Labium, endites and sternum dark brown. Abdomen slightly elongated, dark greyish brown with pattern composed of four pairs of whitish patches posteriorly and narrow white margins in anterior half. Venter greyish. Spinnerets dark. First pair of legs long and robust, with slightly swollen tibiae; only single stout short tibial spine present, metatarsi I with one pair of ventral spines. Other legs yellow, femora tinged with grey. Leg hairs and spines brown. Pedipalp brown, clothed in long dense dark hairs. Palpal tibiae short, with serrated apophysis, its upper surface with several small denticles and denticulate lobe on its dorsal surface (Figs 119–122); bulb small, oval; embolus long, its basal $\frac{2}{3}$ broad, tip fine and directed retrolaterally; tip of cymbium curved towards retrolateral side (Figs 119–122).

Female.

Similar to male, slightly paler in colour, with whitish scales surrounding all eyes of anterior row. Pattern on abdomen more contrasted than in male, white margins broader and median spots larger. Abdomen clothed in greyish hairs, longer at anterior edge. Venter of abdomen pale. Legs yellow. Epigyne wider than long, with two lateral pockets at epigastric furrow and large shallow central depression (Fig. 123). Copulatory openings placed in posterior part of epigyne; seminal ducts wide and weakly sclerotized in inlet parts, narrowed distally; accessory glands very large, spherical (Fig. 124).

Holotype: ♂ SOUTH AFRICA: *KwaZulu-Natal*: Ophathe Game Reserve, 28°23.202'S 31°24.077'E, 505 m, rocky mountainside, active searching, 1.x.2008, C. Haddad (NCA, 2008/4058).

Paratypes: SOUTH AFRICA: *KwaZulu-Natal*: 1♂ 3♀ Ndumo Game Reserve, near main camp, 26°55.221'S 32°18.560'E, broadleaf woodland, canopy fogging *Combretum molle*, 29.vi.2010, C. Haddad, D. Fourie & J. Saaijan (NCA, 2012/1815); 1♂ 1♀ same data (MRAC); 3♂ 4♀ Ophathe Game Reserve, 28°25.344'S 31°23.957'E, 897 m, montane grassland, beating short shrubs, 4.x.2008, C. Haddad (NCA, 2008/3966). *Mpumalanga*: 1♂ Kruger National Park, Satara, N'wanetsi, 24°24.120'S 31°44.700'E, ii.2009, B. Reynolds (NCA, 2010/2722).

Distribution: Species distributed in eastern South Africa (Fig. 139).

Habitat and biology: This species was collected from subtropical savanna by beating short shrubs and canopy fogging.

Pseudicius elegans Wesolowska & Cumming, 2008

Figs 125, 126

Pseudicius elegans: Wesolowska & Cumming 2008: 208, figs 135–143.

Wesołowska & Cumming (2008) described the female; structure of epigyne as in Figs 125, 126.

Material examined: SOUTH AFRICA: *Free State*: 1♀ Brandfort district, Amanzi Private Game Reserve, 28°35.631'S 26°26.380'E, grassland, canopy fogging *Acacia karroo*, 23.xii.2010, V. Butler (NCA, 2012/1821).

Distribution: Previously known only from the type locality in Zimbabwe, recorded for the first time in South Africa (Fig. 139).

Habitat and biology: The specimen was collected by fogging in *Acacia* woodland in the Grassland Biome.

***Pseudicius femineus* sp. n.**

Figs 127, 128

Etymology: From Latin *femineus* (womanly), referring to discovery of the female only.

Diagnosis: The female is slightly similar to that of *Pseudicius maculatus* Haddad & Wesołowska, 2011 from the Free State in South Africa, but may be recognized by the position of the epigynal depression, which is placed posteriorly (versus medially). Male unknown.

Description:

Female.

Measurements. Cephalothorax: length 2.1, width 1.6, height 0.7. Abdomen: length 3.4, width 2.2. Eye field: length 0.8, anterior width 1.0, posterior width 1.1.

Carapace oval, flat, brown, with black eye field; surface clothed in dense grey hairs, with longer brown bristles only near eyes. Anterior median eyes encircled by creamy-

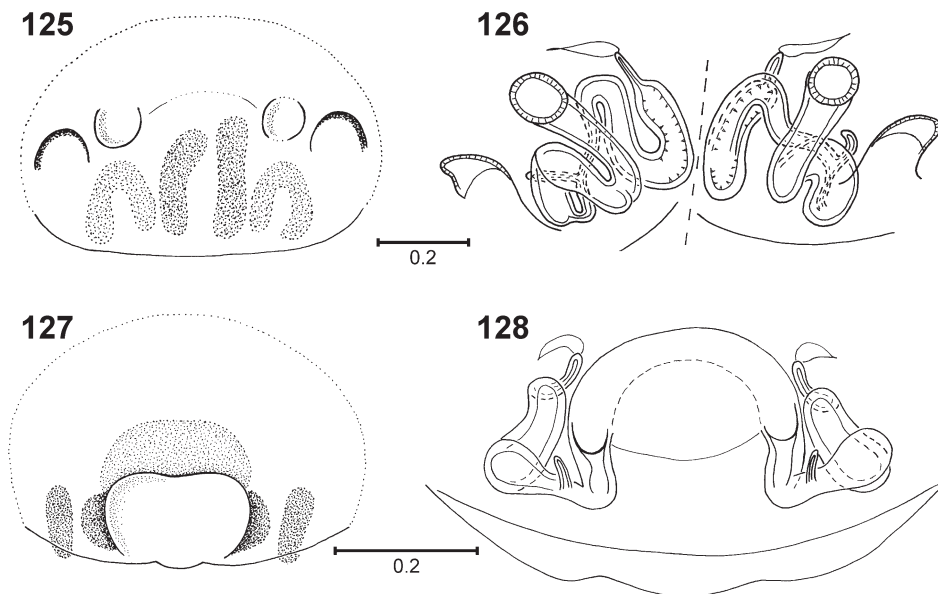

Figs 125–128. *Pseudicius elegans* ♀ (125, 126) and *P. femineus* sp. n., holotype ♀ (127, 128): (125, 127) epigyne, ventral view; (126, 128) internal structure of epigyne.

white scales. Lateral carapace margins fringed with thin black lines, with white stripes above these lines. Stridulatory apparatus present. Sternum and mouthparts dark brown, tips of endites paler, clypeus with white hairs. Abdomen elongate, dark grey, with pattern composed of four pairs of transverse patches submarginally and ill-defined paler median area in anterior half of abdomen. Venter pale. Spinnerets grey. Legs yellow, bearing darker hairs. Epigyne very broad, with deep posterior excavation plugged with waxy secretion; anterior part of excavation forming a deep pocket, with gonopores placed laterally in excavation (Fig. 127); seminal ducts short, spermathecae strongly sclerotized, single-chambered (Fig. 128).

Holotype: ♀ SOUTH AFRICA: *Eastern Cape*: Port Elizabeth, Lovemore Park, 34°00.282'S 25°31.597'E, night collecting, bark and foliage, 1.i.2010, C. Haddad (NMBA).

Distribution: Known only from the type locality (Fig. 139).

Habitat and biology: The holotype was collected in a suburban garden at night, hanging from the bark of a tree by a silk dragline.

***Pseudicius flabellus* sp. n.**

Figs 129–132

Etymology: Derived from Latin *flabellum* (a fan), in reference to the shape of the male palpal tibial apophysis.

Diagnosis: This species is closely related to *Pseudicius dependens* Haddad & Wesolowska, 2011 from central South Africa and *P. dentatus* sp. n. described above. The male

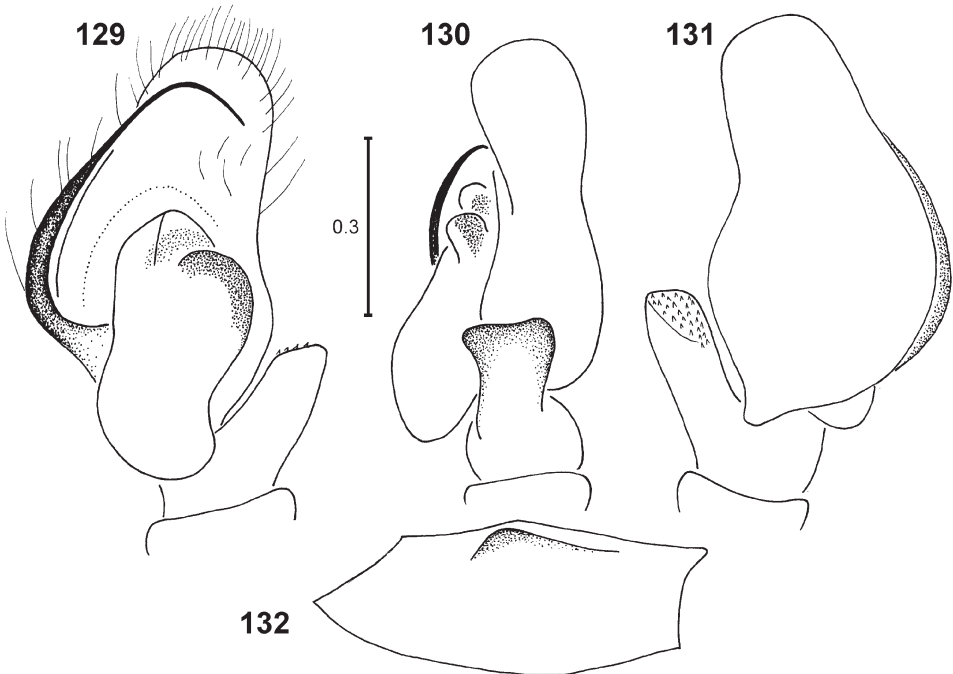

Figs 129–132. *Pseudicius flabellus* sp. n., holotype ♂: (129) palpal organ, ventral view; (130) same, lateral view; (131) same, dorsal view; (132) palpal femur.

differs from both by the shape of the cymbium tip (without the retrolateral outgrowth that is present in the other two species). The tibial apophysis of this species is larger and has a unique shape, with a broad, blunt end and some small denticles on the upper surface. Female unknown.

Description:

Male.

Measurements. Cephalothorax: length 2.0, width 1.4, height 0.6. Abdomen: length 2.3, width 1.4. Eye field: length 0.8, anterior width 1.1, posterior width 1.2.

Shape of body typical for the genus, elongate and flattened. Carapace brown, brilliant, eyes surrounded by black area; traces of paler median streak on posterior part of thoracic area. Carapace covered in adpressed colourless hairs, with long brown bristles near eyes and some whitish hairs on eye field. White hairs form clypeal mat and pale stripes on sides of carapace. Stridulatory bristles present on sides of carapace. Sternum, chelicerae and labium brown, endites slightly paler. Abdomen elongate, brown, clothed in colourless hairs, with longer brown setae at anterior edge; sides streaked with white, with traces of paler median belt. Venter dark. Spinnerets brownish. Legs greyish yellow (partially damaged, first pair missing). Femur of pedipalp slightly longer than in *P. dependens*, with small outgrowth on ventral surface (Fig. 132). Tibial apophysis flabelliform, with broad blunt end, inner and dorsal surface of apophysis dotted with minute denticles (Figs 129–131); embolus attached to bulb prolaterally, with sharp initial and distal bends, gradually narrowing from base to tip (Fig. 129).

Holotype: ♂ SOUTH AFRICA: *Western Cape*: Malmesbury, Rondeberg, 33°24'S 18°16'E, 25.x.1987, R. Wels (NMBA).

Distribution: Known only from the type locality (Fig. 139).

Habitat and biology: The type locality is in the Fynbos Biome.

***Pseudicius imitator* sp. n.**

Figs 95, 133–138

Etymology: From Latin *imitator* (one that imitates, a resembler), in reference to the similarity of this species to *P. venustus*.

Diagnosis: Closely related to *Pseudicius venustus* Wesolowska & Haddad, 2009 from the KwaZulu-Natal Province, South Africa. The male differs by the shape of bulb and the shorter embolus (its base is placed prolaterally, whereas proximally in *P. venustus*). Females of both species are very difficult to recognize; *P. imitator* sp. n. has shorter seminal ducts and long accessory glands.

Description:

Measurements (♂/♀): Carapace length 1.6–1.7/1.9–2.0, width 1.0–1.2/1.1–1.3, height 0.5/0.6. Abdomen length 1.9–2.0/1.9–3.6, width 1.2–1.3/1.2–2.3. Eye field length 0.6–0.7/0.7–0.8, anterior width 0.9/1.0, posterior width 1.0/1.1.

Male.

General appearance as in Fig. 95; body elongate. Carapace low, flattened, dark brown, eye field black with metallic shine. Short greyish hairs on carapace, with brown bristles in vicinity of eyes; some white and fawn scale-like hairs at anterior median

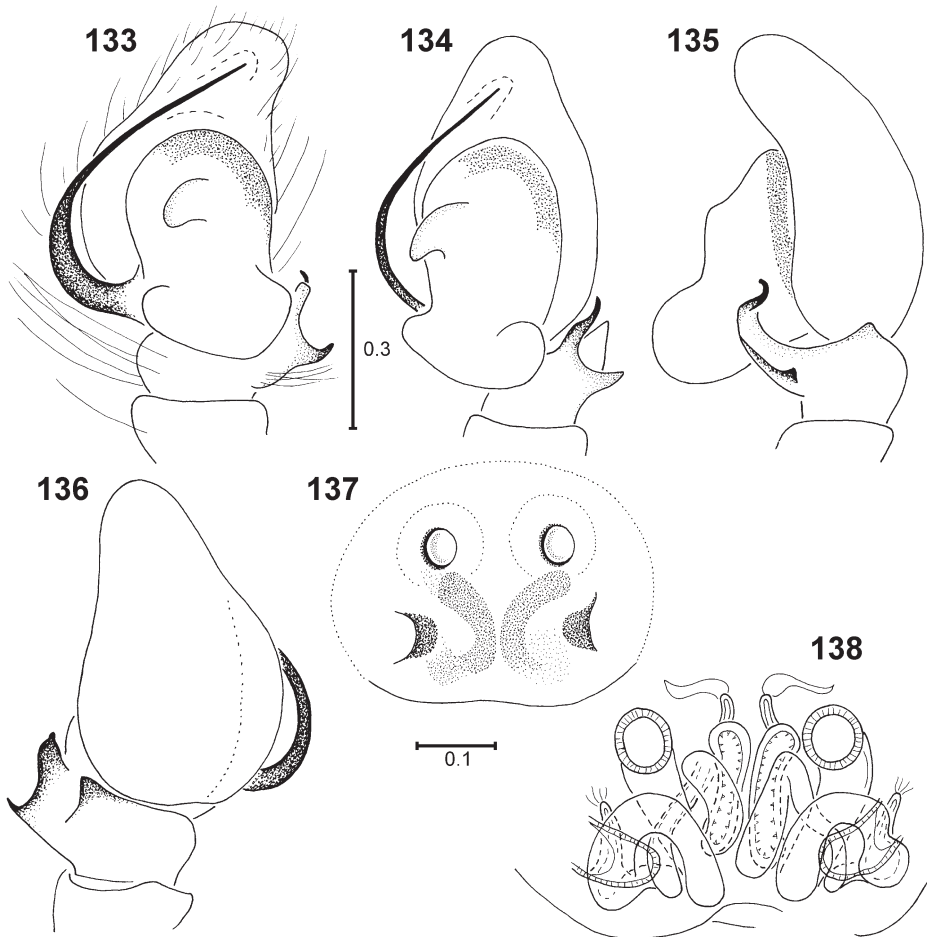

Figs 133–138. *Pseudicius imitator* sp. n., paratype ♂ (133–136) and paratype ♀ (137, 138): (133) palpal organ, ventral view; (134) same, ventrolateral view; (135) same, lateral view; (136) same, dorsal view; (137) epigyne, ventral view; (138) internal structure of epigyne.

eyes. Mouthparts and sternum brown. Stridulatory apparatus of the carapace-leg type. Abdomen elongated, black, with three pairs of small white spots. Venter greyish brown. Spinnerets dark. First pair of legs stout, dark brown, tibiae slightly swollen; tibiae with single short spine prolaterally, metatarsi with two pairs of ventral spines. Other legs brownish, with fine, long brown hairs on legs. Pedipalps brown; palpal tibia with forked retrolateral apophysis, ventral prong longer and with curved tip, and smaller tooth-like dorsal apophysis (Figs 133–136); embolus originating proximally on prolateral side, tip directed retrolaterally (Fig. 133).

Female.

Similar to male but slightly paler in colour. Carapace with pale hairs forming patch near fovea and fringe along lateral margins. Abdominal pattern composed of cream band along anterior edge and four pairs of spots on a brown background, with brown and

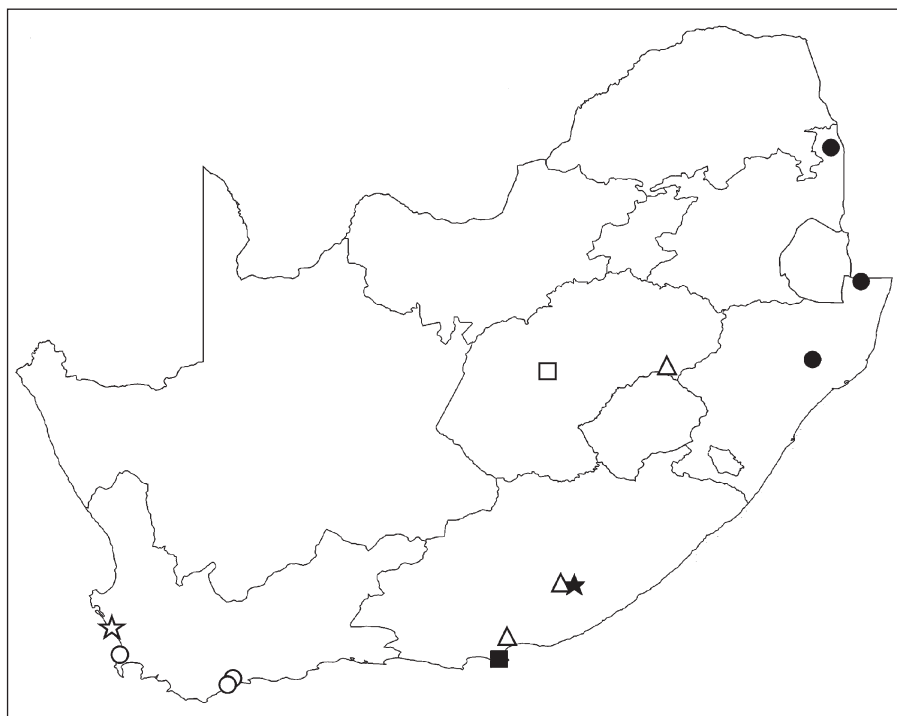

Fig. 139. Distribution of *Pseudicius africanus* (white circles), *P. dentatus* sp. n. (black circles), *P. elegans* (white square), *P. femineus* sp. n. (black square), *P. flabellus* sp. n. (white star), *P. imitator* sp. n. (black star) and *P. maculatus* (white triangles) in South Africa.

whitish hairs on abdomen. All legs yellow, first pair similar in build to others (not stouter as in male). Epigyne oval, with two rounded depressions anteriorly and pair of pouches posteriorly (Fig. 137); internal structure as in Fig. 138, accessory glands long.

Holotype: ♂ SOUTH AFRICA: *Eastern Cape*: Amatola Mountains, Hogsback, Tyume forest, 32°36.195'S 26°56.308'E, 1180 m, Afromontane forest, canopy fogging mixed trees, 29.ix.2011, J. Neethling & C. Luwes (NCA, 2012/1824).

Paratypes: SOUTH AFRICA: *Eastern Cape*: 4♂ 11♀ Amatola Mtns, Hogsback, Ashfield-on-Hogsback, 32°34.993'S 26°55.472'E, 1330 m, Afromontane forest, canopy fogging mixed trees, 30.ix.2011, J. Neethling & C. Luwes (NCA, 2012/1825); 1♂ 1♀ same data (MRAC).

Distribution: Known only from the type locality (Fig. 139).

Habitat and biology: The species was collected by canopy fogging mixed forest.

Pseudicius maculatus Haddad & Wesolowska, 2011

Pseudicius maculatus: Haddad & Wesolowska 2011: 115, figs 193–198.

Haddad & Wesolowska (2011) described both sexes.

Material examined. SOUTH AFRICA: *Eastern Cape*: 2♂ Addo Elephant Park, 33°35'S 25°40'E, M. Meyer (NCA, 76/1950); 2♂ 2♀ Amatola Mtns, Hogsback, 32°34.635'S 26°56.610'E, 1520 m, open grassland, rocky hillside, under rocks, 24.iv.2012, C. Haddad (NMBA).

Distribution: A species described from the central part of South Africa, recorded from the Eastern Cape for the first time (Fig. 139).

Habitat and biology: A tree- and shrub-dwelling species from the Grassland Biome, recorded from the Thicket Biome for the first time.

Genus *Rhene* Thorell, 1869

***Rhene amanzi* sp. n.**

Figs 140, 141

Etymology: From Amanzi Private Game Reserve, where the holotype was collected; a noun in apposition.

Diagnosis: The species is easily recognised by the characteristic embolus, which forms a large triangular plate. Female unknown.

Description:

Male.

Measurements. Carapace length 1.5, width 1.6, height 0.6. Abdomen length 1.7, width 1.5. Eye field length 1.1, anterior width 1.0, posterior width 1.6.

Small, robust, flat spider. Carapace trapezoid, short and wide, eye field pitted; dense dark fine hairs cover carapace. Eye field very large, trapezoid, occupying most of dorsum. Whole body uniformly coloured, dark brown, almost black. Abdomen very flat, with dorsal scutum; anterior edge with fringe of dense hairs. All legs dark brown, clothed in dense hairs. First legs stouter than others, without plumose setae (characteristic for the majority of congeners). Pedipalps dark, tibiae very short, tibial apophysis curved (Fig. 141); bulb dark brown, anterior haematodocha clearly separated; embolus somewhat triangular, very large and broad, slightly curved (Fig. 140).

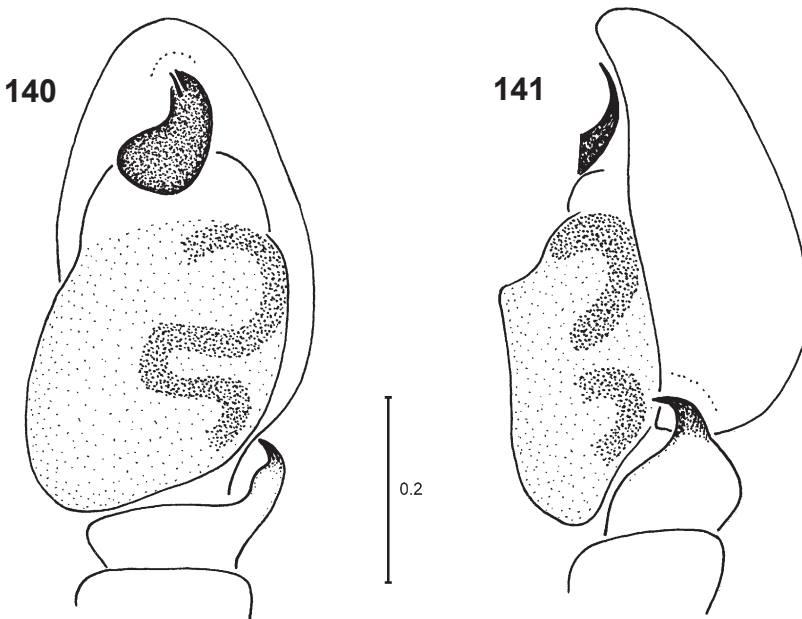

Figs 140, 141. *Rhene amanzi* sp. n., holotype ♂: (140) palpal organ, ventral view; (141) same, lateral view.

Holotype: ♂ SOUTH AFRICA: *Free State*: Brandfort district, Amanzi Private Game Reserve, 28°36.115'S 26°26.014'E, grassland, sweeps, 19.xii.2010, V. Butler (NCA, 2012/1822).

Distribution: Known only from the type locality (Fig. 155).

Habitat and biology: In contrast to the majority of South African congeners, which are associated with woody vegetation, the holotype of this species was collected in open grassland.

Rhene facilis Wesolowska & Russell-Smith, 2000

Figs 96, 97, 142–145

Rhene facilis: Wesolowska & Russell-Smith 2000: 93, figs 251–255.

Diagnosis: The male can be easily recognised from South African congeners by the distinctive markings on the body and the fine, slightly curved embolus. Females can be distinguished by the weakly sclerotized epigyne with an anterior arch and S-shaped copulatory openings.

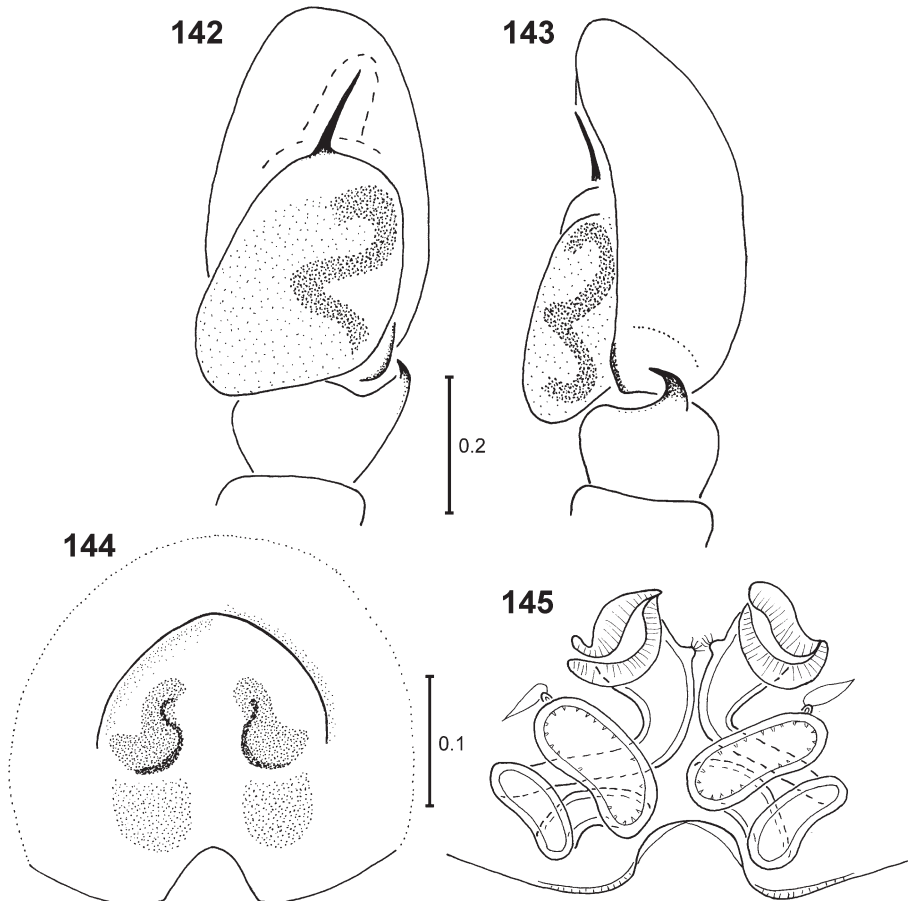

Figs 142–145. *Rhene facilis*, ♂ (142, 143) and ♀ (144, 145): (142) palpal organ, ventral view; (143) same, lateral view; (144) epigyne, ventral view; (145) internal structure of epigyne.

Redescription:

Measurements (♂/♀). Carapace length 1.9/1.6, width 2.0/1.5, height 0.7/0.6. Abdomen length 2.2/2.5, width 1.9/1.5. Eye field length 1.3/1.0, anterior width 1.3/1.0, posterior width 2.0/1.5.

Male.

General appearance as in Fig. 96. Robust, flattened spider, with trapezoid carapace; carapace almost black, eye field pitted, some colourless hairs on carapace; white hairs forming thin line along anterior margin of eye field and median streak near posterior of carapace. Eye field large, trapezoid, eyes of last row placed on small tubercles. Chelicerae dark brown; labium and endites with narrow paler line along tips. Sternum brown. Abdomen dark brown, its anterior edge with median patch of white hairs, and fine transverse white band in posterior half (Fig. 96). Venter brownish grey. Spinnerets dark. Legs brown, only tarsi slightly lighter, with some white scales on femora. First pair stouter and longer than others, with dense hairs on ventral surfaces of tibiae. Pedipalps dark, tibial apophysis curved (Fig. 143); embolus thin and slightly curved (Fig. 142).

Female.

General appearance as in Fig. 97. Carapace reddish brown; eye field black, pitted; colourless delicate hairs cover carapace. Mouthparts and sternum pale brown. Abdomen more elongate than in male, ovoid, flat, greyish brown; dorsum covered with scutum, with delicate hairs on it. Spinnerets dark. First pair of legs orange-brown, with black tibiae, metatarsi and tarsi; tibiae and metatarsi of other legs with black tips (Fig. 97). Pedipalps yellowish orange. Epigyne very small, weakly sclerotized (Fig. 144), with broad anterior arch, posterior notch, and S-shaped copulatory openings; internal structure as in Fig. 145.

Material examined: SOUTH AFRICA: *KwaZulu-Natal*: 1♀ iSimangaliso Wetlands Park, near Mission Rocks Beach, 28°15.885'S 32°28.880'E, 83 m, indigenous bush, canopy fogging *Albizia adianthifolia*, 12.v.2012, J. Neethling & C. Luwes (NMSA, 26449); 3♂ 2♀ same locality, St Lucia, 28°23.038'S 32°24.428'E, 21 m, coastal forest, canopy fogging *Trichilia dregeana*, 13.v.2012, J. Neethling & C. Luwes (NMSA, 26458); 1♀ same locality, Crocodile Centre, 28°21.407'S 32°25.183'E, 24 m, wetland, canopy fogging *Breonadia salicina*, 14.v.2012, J. Neethling & C. Luwes (NMSA, 26493); 1♀ Ndumo Game Reserve, Shokwe Pan, 26°52.424'S 32°12.652'E, 43 m, *Ficus* forest, canopy fogging *Kigelia africana*, 5.vii.2009, C. Haddad, R. Lyle & V. Butler (NCA, 2012/1816); 2♂ same data (NCA, 2012/1817).

Distribution: Described from Tanzania, found for the first time in South Africa (Fig. 155).

Habitat and biology: Collected by canopy fogging various trees in forest and savanna woodland habitats.

Remark: The female is described for the first time.

Rhene lingularis Haddad & Wesolowska, 2011

Rhene lingularis: Haddad & Wesolowska 2011: 121, figs 207–209.

Haddad & Wesolowska (2011) described the male; female unknown.

Material examined: SOUTH AFRICA: *Western Cape*: 1♂ Malmesbury, 33°24'S 18°16'E, beating, 25.x.1987, A. Wels (NMBA).

Distribution: Described from the Free State Province in South Africa, recorded from the Western Cape for the first time, extending the range by approximately 1000 km westwards (Fig. 155).

Habitat and biology: Previously collected by sweep-netting in grassland habitats, recorded here by beating vegetation in the Fynbos biome.

***Rhene punctatus* sp. n.**

Figs 146–148

Etymology: From Latin *punctus* (a point), in reference to the dotted pattern on the abdomen.

Diagnosis: This species can be distinguished by the abdominal pattern, comprising of a series of black dots on a pale brown dorsum. The structure of the male palp is similar to that in another southern African congener, *R. lingularis*, but differs in having a clearly longer tibial apophysis and by the shape of the membranous apophysis accompanying the embolus. Female unknown.

Description:

Male.

Measurements. Cephalothorax: length 1.8, width 1.8, height 0.8. Abdomen: length 2.1, width 1.8. Eye field: length 1.0, anterior width 1.2, posterior width 1.8.

Very flat, stocky, hairy spider. Carapace flat, very broad, almost square; carapace dark brown, densely clothed in long whitish hairs. Eye field large, trapezoid; first and second rows of eyes close to each other. Clypeus very low, brown. Chelicerae unidentate; labium and sternum dark brown, endites with slightly paler tips. Abdomen rounded, strongly flattened, its anterior edge extending over posterior part of carapace; abdomen pale brown, with numerous black dots scattered on whole dorsum and large trapezoid black patch in anterior part; dense white hairs cover abdomen. Venter dark brown. Spinnerets dark. First pair of legs blackish, metatarsi and tarsi lighter, distinctly thicker than others, their tibiae slightly swollen, with long dense hairs on ventral surface; legs II–IV orange, only femora darker, distal ends of remaining segments with a dark ring.

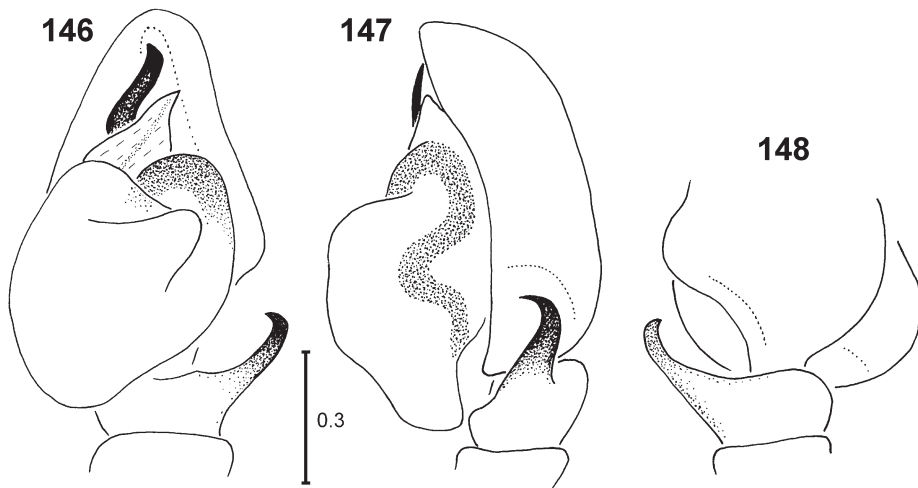

Figs 146–148. *Rhene punctatus* sp. n., holotype ♂: (146) palpal organ, ventral view; (147) same, lateral view; (148) palpal tibia, dorsal view.

Metatarsi of first legs with two pairs of ventral spines. Pedipalps dark; bulb large, very convex (Fig. 146); embolus long and broad, linguliform, with large accompanying membranous conductor (Fig. 146); palpal tibia short, with hooked apophysis, longer than in congeners (Fig. 147); cymbium with basal retrolateral cavity corresponding to the tibial apophysis (Fig. 148).

Holotype: ♂ SOUTH AFRICA: *KwaZulu-Natal*: Cathedral Peak Nature Reserve, Rainbow Gorge, 28°56.982'S 29°13.874'E, 1400 m, base of grasses and ferns, 19.i.2011, C. Haddad (NCA, 2010/2719).

Distribution: Known only from the type locality (Fig. 155).

Habitat and biology: Found close to the soil surface in Afromontane grassland.

***Rhene timidus* sp. n.**

Figs 98, 149, 150

Etymology: From Latin *timidus* (cautious), in reference to the very delicate sclerotization of the epigyne.

Diagnosis: The species may be recognized by the structure of the epigyne, with characteristic spiralling ridges around the copulatory openings and the seminal ducts broader than in other African congeners. Male unknown.

Description:

Female.

Measurements. Cephalothorax: length 2.4, width 2.5, height 0.9. Abdomen: length 3.5, width 2.8. Eye field: length 1.5, anterior width 1.4, posterior width 2.5.

General appearance as in Fig. 98. Larger than female of *R. facilis*; shape of body typical for members of the genus, flat and robust. Carapace greatly broadened, with large trapezoid eye field; dorsum of carapace brown, eyes with black rings, dense whitish hairs cover whole surface. Clypeus very low, dark. Chelicerae unidentate; labium, endites and sternum brown. Abdomen slightly lighter than carapace, brownish fawn, unicoloured, with three pairs of sigilla. Venter brown. Spinnerets dark. Legs brown, first pair stouter than others, with blackish metatarsi and tarsi; long dense black hairs cover ventral surface of tibiae; tibiae I short, with single short prolateral spine; metatarsi I very short, with two pairs of ventral spines; legs with scattered whitish hairs. Epigyne weakly

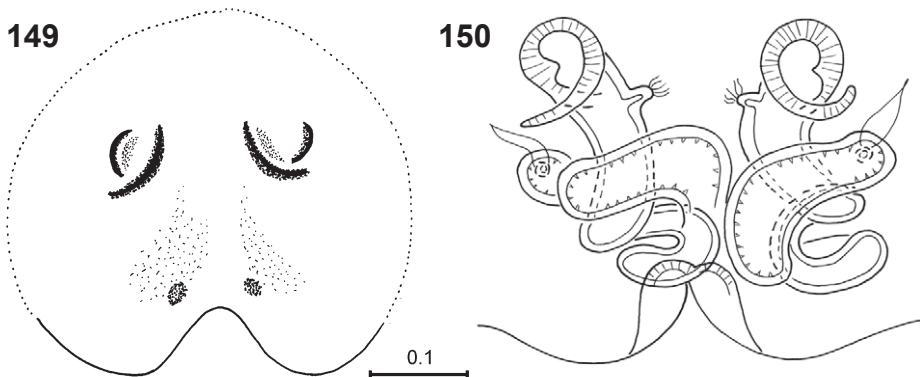

Figs 149, 150. *Rhene timidus* sp. n., holotype ♀: (149) epigyne, ventral view; (150) internal structure of epigyne.

sclerotized, with notch at posterior edge (Fig. 149); copulatory openings surrounded by spiralling ridges; seminal ducts broad, similarly broad along their length, with accessory glands present (Fig. 150).

Holotype: ♀ SOUTH AFRICA: *Eastern Cape*: Amatola Mtns, Hogsback, Never Daunted Guest House, 32°35.702'S 26°55.815'E, 1250 m, canopy fogging, mixed garden shrubs, 7.i.2010, C. Haddad, C. Griswold & H. Wood (NCA, 2012/1101).

Distribution: Known only from the type locality (Fig. 155).

Habitat and biology: Collected by fogging mixed broadleaved shrubs in a garden.

Genus *Sibianor* Logunov, 2001
Sibianor victoriae Logunov, 2000

Figs 151–154

Sibianor victoriae: Logunov 2000: 276, figs 292–293.

Diagnosis: The male is similar to *Sibianor kenyaensis* Logunov, 2000, but the position of the tegular knob of the palp is different. The female may be distinguished by the multi-chambered spermathecae.

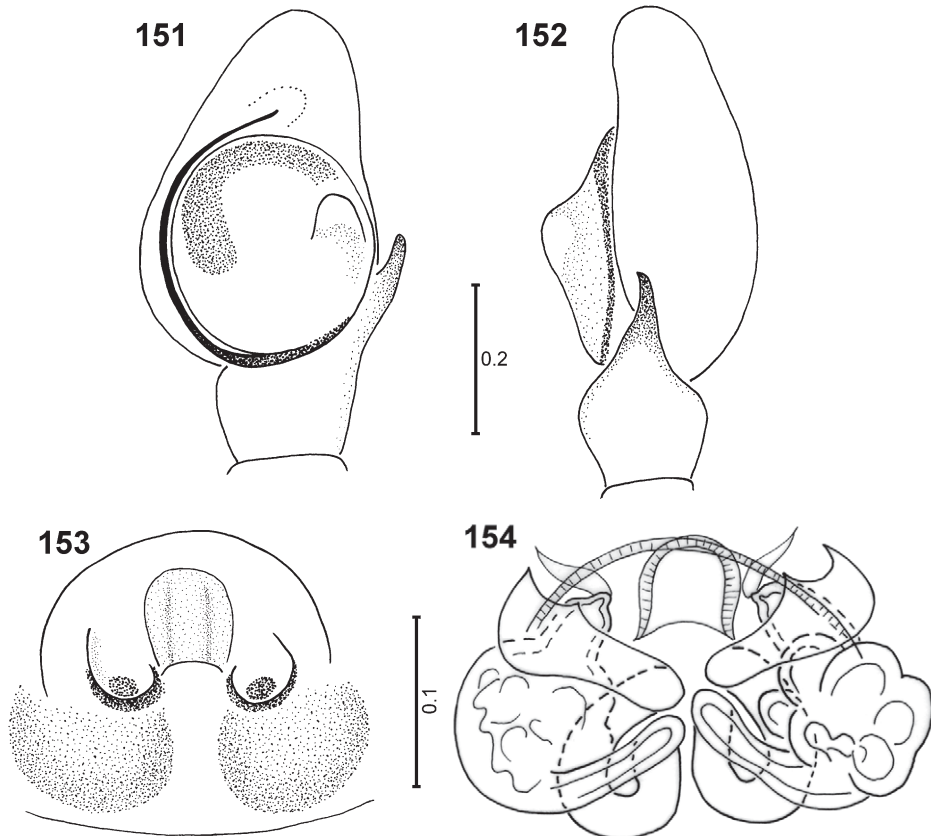

Figs 151–154. *Sibianor victoriae*, ♂ (151, 152) and ♀ (153, 154): (151) palpal organ, ventral view; (152) same, lateral view; (153) epigyne, ventral view; (154) internal structure of epigyne.

Redescription:

Measurements ($\text{♂}/\text{♀}$). Cephalothorax: length 1.0–1.2/1.1, width 0.7–0.8/0.9, height 0.5–0.6/0.6. Abdomen: length 1.0–1.3/1.5, width 1.3/1.1. Eye field: length 0.5–0.7/0.7, anterior width 0.7–0.9/0.8, posterior width 0.8–1.1/1.1.

Male.

Description in Logunov (2000). Endites with small tooth. First legs with slightly swollen tibiae, their ventral surface with feathery bristles. Fourth pairs of legs with two ventro-apical spines on metatarsi. Pedipalps with round bulb and retrolateral swelling; embolus originating basally on retrolateral side, fine, curving around prolateral side of bulb (Fig. 151); palpal tibia with single simple apophysis (Fig. 152).

Female.

Very small spider, ranging from 2.0–2.6 mm. Carapace oval, widest at last row of eyes; carapace dark brown, densely covered in very small white scales and short hairs, with some brown bristles among them. Clypeus with dense white hairs. Chelicerae unidentate. Sternum brown, labium and endites with paler tips. Abdomen brown, with white hairs and scales and brown bristles on dorsum. Venter dark. Spinnerets brownish. Legs and pedipalps dark yellowish; last pair of legs without spines. Epigyne typical for Harmochireae, with central pocket (Fig. 153); spermathecae strongly sclerotized, multi-chambered (Fig. 154).

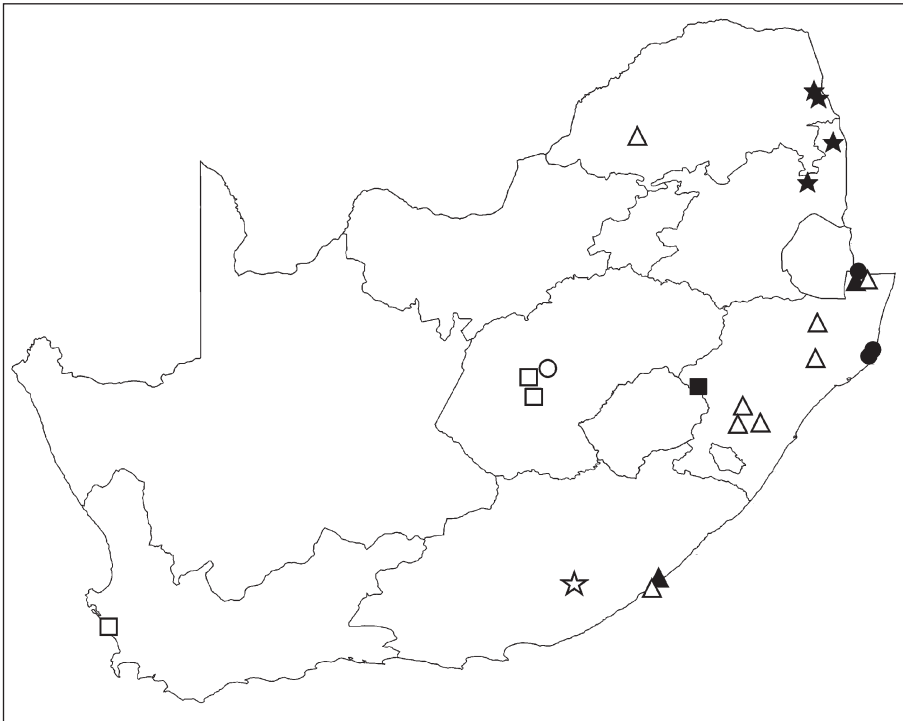

Fig. 155. Distribution of *Rhene amanzi* sp. n. (white circle), *R. facilis* (black circles), *R. lingularis* (white squares), *R. punctatus* sp. n. (black square), *R. timidus* sp. n. (white star), *Sibianor victoriae* (black stars), *Thyenula fidelis* (white triangles) and *T. magna* (black triangles) in South Africa.

Material examined: SOUTH AFRICA: *Mpumalanga*: 1♀ Kruger National Park (KNP), Mopani, Dzombo, 23°26.700'S 31°22.860'E, sweepnetting, xi.2003, B. Reynolds (NCA, 2010/2729); 1♂ same data but iii–iv. 2008 (NCA, 2010/2723); 1♂ KNP, Mopani, Mooiplaas, 23°34.920'S 31°27.840'E, sweepnetting, xi.2008, B. Reynolds (NCA, 2010/2726); 1♂ KNP, Satara, 24°24.060'S 31°44.460'E, sweepnetting, ix.2008, B. Reynolds (NCA, 2010/2728); 1♀ KNP, Pretoriuskop, Kambeni, 25°09.180'S 31°15.840'E, sweepnetting, ix–x.2008, B. Reynolds (NCA, 2010/2724); 1♂ same data (NCA, 2010/2730); 1♂ KNP, Pretoriuskop, Numbi, 25°07.380'S 31°12.480'E, sweepnetting, ix–x.2008, B. Reynolds (NCA, 2010/2727).

Distribution: Species previously known only from the type locality in Kenya, recorded for the first time in South Africa (Fig. 155).

Habitat and biology: Species collected close to the ground by sweepnetting grasses and herbs in savanna habitats. Its small size, somewhat rounded body and dark colouration suggest that this species may mimic ladybird beetles (Coleoptera: Coccinellidae).

Remark: The female is described here for the first time.

Genus *Thyenula* Simon, 1902

Thyenula fidelis Wesolowska & Haddad, 2009

Thyenula fidelis: Wesolowska & Haddad 2009: 90, figs 196–199.

Wesolowska & Haddad (2009) described both sexes.

Material examined: SOUTH AFRICA: *Eastern Cape*: 1♀ Kei Mouth, 32°41'S 28°22'E, coastal dune forest, 6.xii.2005, C. Haddad (NMBA). *KwaZulu-Natal*: 1♂ Gilboa Plantation, Karkloof Midlands, 29°18'S 30°04'E, pitfall traps, grassland, 26.iii.2009, J. Pryke (NCA, 2010/5775); 1♂ Midlands, Boston, Good Hope Plantation, 29°39'S 29°58'E, sweepnetting, indigenous forest, 23.ii.2009, J. Pryke (NCA, 2010/5660); 1♀ Ophathe Game Reserve, 28°25.344'S 31°23.957'E, 897 m, montane grassland, sifting leaf-litter, 4.x.2008, C. Haddad (NCA, 2008/3914); 2♂ 2♀ Pietermaritzburg, 29°37'S 30°23'E, in humid forest, town bush, 18.iv.1976, A. Russell-Smith (BMNH); 1♂ 2♀ same locality, 15.ix.1976, ground layer, A. Russell-Smith (BMNH); 7♂ Vryheid, Ngome State Forest, 27°46'S 31°27'E, pitfall traps, ecotone pine, 1.xii.1992, M. van der Merwe (NCA, 97/563); 1♂ same data (NCA, 97/562). *Limpopo*: 1♀ Bela-Bela/Warmbaths, Klein Kariba Holiday Resort, 24°17'S 28°06'E, sweep-netting grass, 22.xi.1996, J. Leeming (NCA, 97/583).

Distribution: Species known only from the type locality (Ndumo Game Reserve), recorded from several additional localities in KwaZulu-Natal, and also from the Eastern Cape and Limpopo Provinces for the first time (Fig. 155).

Habitat and biology: A ground-dwelling species known from subtropical forest and savanna habitats.

Thyenula magna Wesolowska & Haddad, 2009

Thyenula magna: Wesolowska & Haddad 2009: 92, figs 200–202.

Wesolowska & Haddad (2009) described the male; female unknown.

Material examined: SOUTH AFRICA: *Eastern Cape*: 2♂ Kei Mouth, 32°41'S 28°22'E, coastal dune forest, 6.xii.2005, C. Haddad (NMBA).

Distribution: Previously known only from the type locality (Ndumo Game Reserve), recorded from the Eastern Cape for the first time (Fig. 155).

Habitat and biology: A ground-living spider from savanna and forest habitats.

Genus *Tomomingi* Szűts & Scharff, 2009

Tomomingi szutsi sp. n.

Figs 21, 99, 100, 156–165

Etymology: The species is named after Tamas Szűts, one of the authors of the genus.

Diagnosis: This species is closely related to *Tomomingi holmi* (Prószyński & Żabka, 1983) from the Aberdare Mountains in Kenya. The male may be distinguished by the median apophysis of the bulb, which is bifid in *T. szutsi* sp. n. but hook-shaped in *T.*

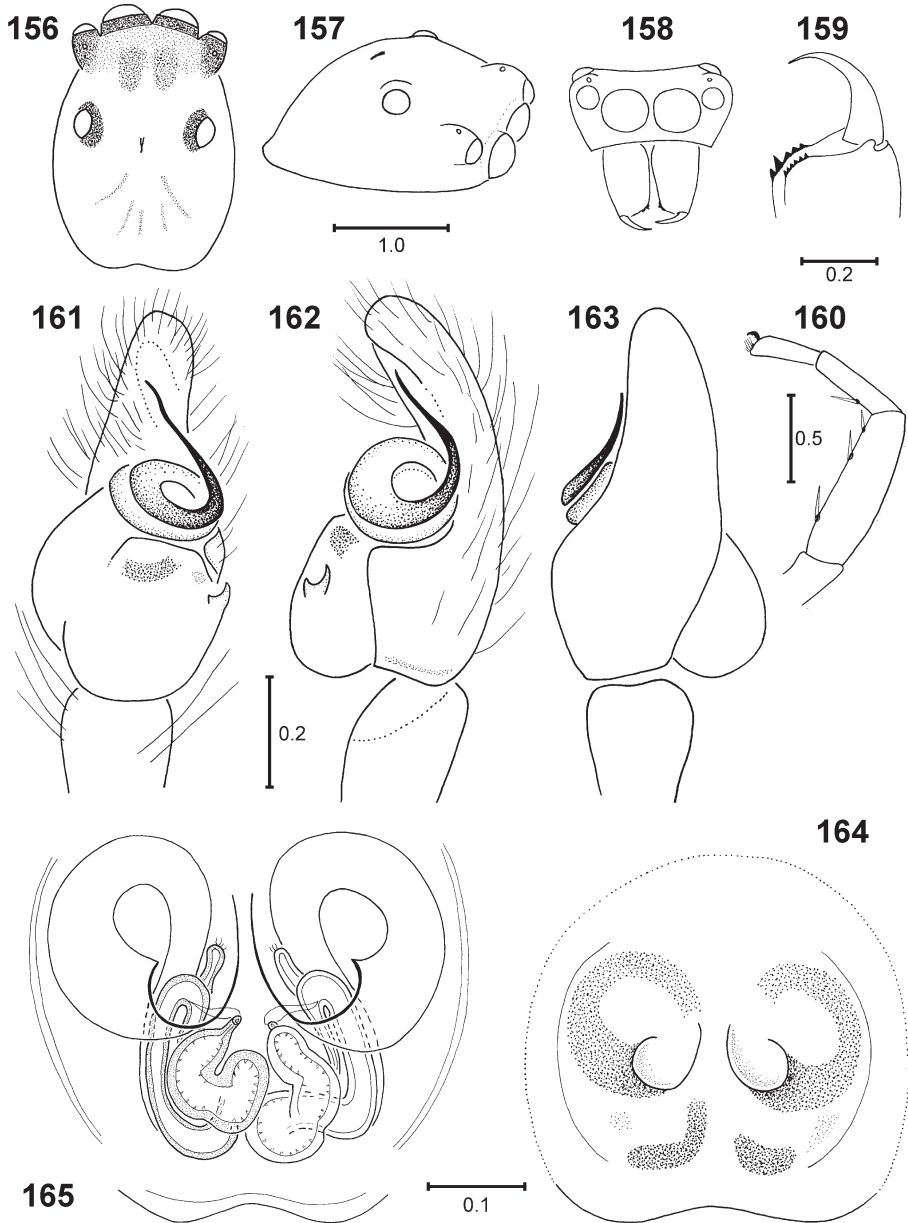

Figs 156–165. *Tomomingi szutsi* sp. n., holotype ♂ (156–163) and paratype ♀ (164, 165): (156) carapace, dorsal view; (157) same, dorsolateral view; (158) same, anterior view; (159) chelicera; (160) first leg; (161) palpal organ, ventral view; (162) same, lateral view; (163) same, dorsal view; (164) epigyne, ventral view; (165) internal structure of epigyne.

holmi, and by the shape of cymbium, which forms a retrolateral enlargement basally (without such an enlargement in *T. holmi*). The females are difficult to tell apart, but the course of the distal part of the seminal ducts and the shape of the spermathecae are different (compare Fig. 164 herein with fig. 32 in Prószyński & Żabka 1983).

Description:

Measurements (♂/♀). Cephalothorax: length 2.0/2.2, width 1.4/1.6, height 0.8/0.8. Abdomen: length 1.9/2.4, width 1.3/1.4. Eye field: length 1.0/1.0, anterior width 1.3/1.4, posterior width 1.2/1.3.

Male.

General appearance as in Figs 21 and 99. Carapace oval (Fig. 156), moderately high, with constriction behind posterior median eyes (Figs 21, 157); posterior slope steep, fovea clearly visible, thoracic part with striae radiating from fovea (Fig. 156). Eye field occupying half of carapace length; eye pattern typical for Hisponinae: eyes on tubercles, posterior medians set very far to the anterior, on the same tubercles as the anterior laterals (Fig. 158). Colouration of carapace brown, slightly darker at margins, eyes with black rings; some brown bristles near eyes and sparse dark hairs on thoracic part. Clypeus low, with few white hairs. Chelicerae brown, pluridentate, with 5 or 6 teeth on both margins (Fig. 159); labium and sternum dark brown, endites slightly paler. Abdomen oval, greyish brown, with broad cream median stripe (Fig. 99); dorsum clothed in brownish hairs. Venter dark, paler along midline. Spinnerets long, dark. Legs brown, covered in dense dark hairs; first legs with three pairs of short ventral spines on tibiae and one pair on metatarsi. Pedipalps brown, with long, dense, dark hairs; palpal tibia without apophysis, cymbium narrow, with enlargement near base on prolateral side (Figs 161, 163); bulb rounded, with small median bicuspid apophysis; embolus with broad base, spirally coiled (Figs 161, 162).

Female.

Similar to male, but colouration clearly lighter and body less hairy (Fig. 100). Epigyne rounded, gonopores placed centrally (Fig. 164); seminal ducts weakly sclerotized, broad initially, forming a loop; accessory glands large (Fig. 165).

Holotype: ♂ SOUTH AFRICA: *Limpopo*: Soutpansberg, Lajuma Mountain Retreat, 23°02.414'S 29°26.687'E, base of grass tussocks, 2.ii.2008, C. Haddad (NCA, 2008/535).

Paratype: 1 ♀ together with holotype (NCA, 2008/535).

Distribution: Known only from the type locality (Fig. 178). This is the first species in the genus recorded from subtropical southern Africa.

Habitat and biology: Similar to its congeners, *T. szutsi* sp. n. was also collected in montane habitats, but the two known specimens were collected in grassland patches within a savanna woodland and forest mosaic. This contrasts with the other species in the genus, which are primarily forest-dwelling.

Remarks: In their revision of the genus *Tomocyrra* Simon, 1900, Szűts and Scharff (2009) established the genus *Tomomingi*, containing six species distributed in the montane rain forests of East Africa (except for a single species known from Guinea). This species shares the obvious synapomorphies for *Tomomingi*: the absence of a retrolateral tibial apophysis in the male palp and the presence of three pairs of ventral spines on the first tibiae (fewer in the related genera *Tomocyrra* and *Tomobella* Szűts & Scharff, 2009).

Genus *Ureta* gen. n.

Etymology: The genus name is an arbitrary combination of letters. Gender feminine.

Type species: *Euophrys quadrispinosa* Lawrence, 1938.

Diagnosis: *Ureta* is a medium-sized salticid with a body shape typical for the family. Both sexes have unidentate chelicerae with a large retromarginal tooth. The male has pedipalps with a short tibia, a tegulum with a large prolateral tooth-like apophysis, and a long, thin, whip-shaped embolus with a large tooth at its base. The female has an epigyne with a clearly developed double pocket at the epigastric furrow, and long seminal ducts that form several loops. The structure of the genitalia of both sexes is unlike those of other salticids. The subfamilial affinities of the genus remain unknown, although it clearly does not belong to Euophryinae, wherein the type species was previously placed, based on the genitalic structure of both sexes.

Ureta quadrispinosa (Lawrence, 1938), **comb. n.**

Figs 53, 101, 102, 166–175

Euophrys quadrispinosa: Lawrence 1938: 523, fig. 40.

Diagnosis: The species with sexually dimorphic colouration (Figs 101, 102) is recognisable by the form of the copulatory organs. The male has a very long embolus with a tooth at its base and a tegulum with a characteristic long prolateral tooth-like apophysis basally. The presence of two white lines along the body is also a useful distinguishing characteristic for the male. The female may be distinguished by the presence of a pair of large pockets close to each other along the epigastric groove and the looping course of the seminal ducts.

Redescription:

Measurements (♂/♀). Cephalothorax: length 2.5–2.8/2.7–3.0, width 2.0–2.2/2.0–2.1, height 0.8–1.0/0.9–1.1. Abdomen: length 2.8–3.1/3.2–4.0, width 1.7–2.2/2.2–2.7. Eye field: length 1.2/1.2–1.4, anterior width 1.6–1.8/1.7–1.9, posterior width 1.5–1.7/1.6–1.8.

Male.

General appearance as in Figs 53, 101 and 166. Carapace rectangular, narrowed posteriorly, moderately high; dark brown with large orange-brown area behind eye field; eyes surrounded by black rings; two thin streaks formed by white hairs run from eyes of row II to posterior edge of carapace; eye field clothed in golden gleaming hairs, with long brown bristles near anterior eyes and short whitish hairs around anterior median eyes. Eye field trapezoid, distance between anterior lateral eyes slightly larger than between posterior laterals. Clypeus very short, brownish. Chelicerae unidentate, tooth on retrolateral margin large (Fig. 167). Endites and labium brown with pale tips; sternum brown, paler centrally. Abdomen ovoid, generally greyish brown, chocolate brown centrally, with two thin light streaks composed of white hairs running from anterior margin and converging above spinnerets (Fig. 166); abdominal dorsum covered in delicate brown hairs, with some longer bristles at anterior margin. Venter and spinnerets brownish grey. Legs brown, distal segments of posterior legs slightly paler; spines brown, femoral spines thicker. Pedipalps brown, with dense white hairs on patella and femur dorsally; palpal tibia short, with single short apophysis (Figs 170–172); tegulum

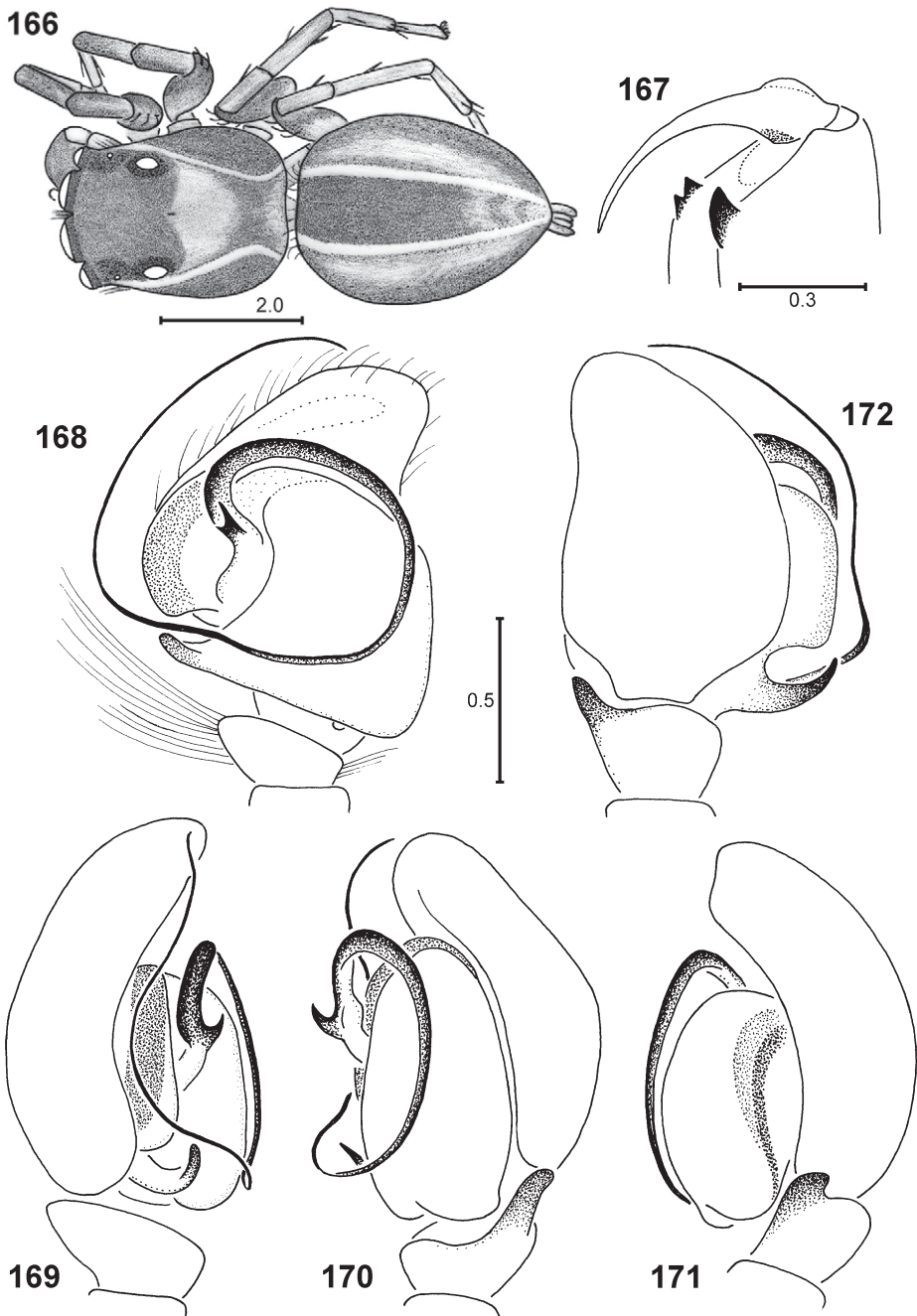

Figs 166–172. *Ureta quadrispinosa*, ♂: (166) habitus; (167) cheliceral dentition; (168) palpal organ, ventral view; (169) same, ventro-prolateral view; (170) same, ventro-retrolateral view; (171) same, retrolateral view; (172) same, dorsal view.

convex, with long thin tooth-like prolateral apophysis basally (Figs 168, 169, 172); embolus long and thin, with large tooth at its base (Figs 168–170).

Female.

General appearance as in Fig. 102. Shape of body as in male. Carapace dark brown, area behind eye field slightly paler; fovea clearly visible. Eyes surrounded by black rings. Some delicate hairs on carapace, long brown bristles at eyes. Mouthparts as in male; sternum yellow, tinged with grey. Abdomen ovoid, dorsum creamy-yellow, with a mosaic of small brownish grey patches; abdominal hairs delicate, brown, longer and denser on anterior edge. Venter similar in colouration to dorsum. Spinnerets brown. Legs dark yellow with brown rings or uniformly brown. Spination of leg I: femora 0-1-1-5 dorsally, tibiae with four pairs ventrally, metatarsi with two pairs ventrally. Epigyne rounded with pair of large pockets close to each other at epigastric furrow, and large rounded gonopores (Figs 173, 174); seminal ducts weakly sclerotized, forming several loops, spermathecae relatively small (Fig. 175).

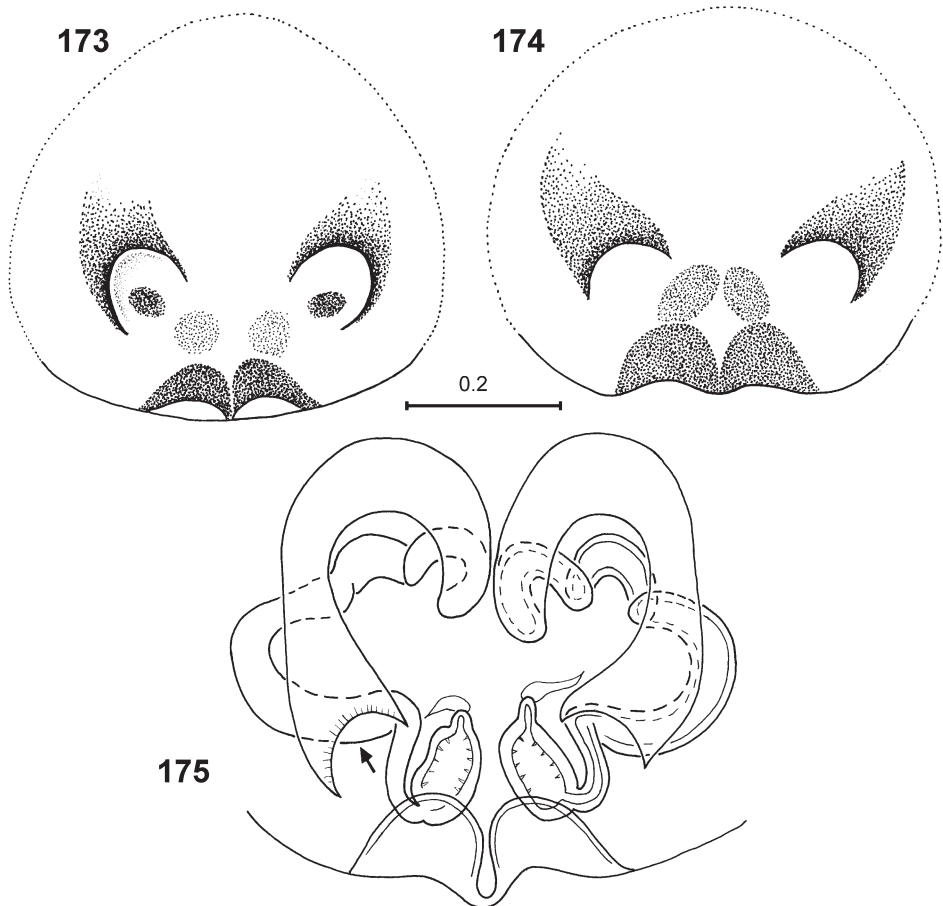

Figs 173–175. *Ureta quadrispinosa*, ♀♀: (173, 174) epigynes, ventral view; (175) internal structure of epigyne.

Holotype (not examined): ♀ SOUTH AFRICA: *KwaZulu-Natal*: Umhlali [29°32'S 31°13'E], R.F. Lawrence (NMSA).

Material examined: SOUTH AFRICA: *KwaZulu-Natal*: 1♂ 3♀ Ingwavuma, 27°07'S 31°59'E, vii.1938, R.F. Lawrence (NMSA, 2412); 6 imm. 1♀ Ophathe Game Reserve, 28°25.344'S 31°23.957'E, 897 m, montane grassland, active searching under rocks, 30.ix.2008, C. Haddad (NCA, 2008/3955); 1♂ same data but sifting leaf-litter, 4.x.2008 (NCA, 2008/3915); 7 imm. 1♂ 4♀ same locality, 28°23.202'S 31°24.077'E, 505 m, rocky mountainside, active searching under rocks, 1.x.2008, C. Haddad (NCA, 2008/4059); 1 imm. 1♂ 2♀ same locality, 28°23.727'S 31°23.643'E, 455 m, Ophathe R. bed, active searching under rocks, 2.x.2008, C. Haddad (NCA, 2008/4232); 1♂ 1♀ same data (MRAC); 2♂ same locality, Ophathe R. crossing, 28°23.727'S 31°23.643'E, under logs, 5.vii.2007, C. Haddad & R. Fourie (NCA, 2007/2947); 1♂ same locality, trail near Imfolozi R., 28°22.555'S 31°23.993'E, under rocks, 5.vii.2007, C. Haddad & R. Fourie (NCA, 2007/2992). *Eastern Cape*: 1♂ Silaka Nature Reserve, 31°39.069'S 29°30.517'E, 32 m, on outside walls of house, 11.i.2011, C. Haddad (NCA, 2010/2719).

Distribution: Species known only from eastern South Africa (Fig. 178). Described from *KwaZulu-Natal*, recorded from the Eastern Cape for the first time.

Habitat and biology: A ground-dwelling species most often found under rocks in mountainous areas in savanna habitats, and on one occasion recorded from coastal forests. Both sexes and the juveniles construct dense silk retreats on the underside of rocks.

Remarks: The male of the species is described here for the first time. Photographs of the holotype female were taken by Galina Azarkina and provided to us for study; we are certain that the specimens listed above are conspecific with the holotype of *Euophrys quadrispinosa*.

Genus *Veissella* Wanless, 1984

Veissella durbani (Peckham & Peckham, 1903)

Figs 176, 177

Portia durbani: Peckham & Peckham 1903: 183, pl. 19, fig. 2; Lawrence 1947: 36; Wanless 1978: 109, figs 13a–g.

Veissella durbani: Wanless 1984b: 190, figs 27a–g; Wesolowska & Haddad 2009: 95, figs 205–209.

Wesolowska & Haddad (2009) redescribed the male.

Female.

Measurements. Cephalothorax: length 2.6, width 2.0, height 1.4. Abdomen: length 2.9, width 1.9. Eye field: length 1.1, anterior width 1.5, posterior width 1.4.

Medium-sized spider, carapace high with abrupt slope posteriorly; carapace brown, eyes surrounded by black rings, some short greyish hairs on carapace, denser near eyes.

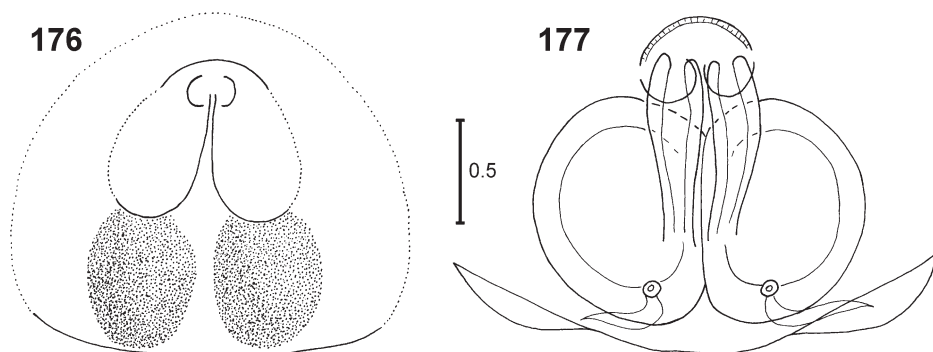

Figs 176, 177. *Veissella durbani*, ♀: (176) epigyne, ventral view; (177) internal structure of epigyne.

Eye field trapezoid, its anterior width slightly larger than posterior width; posterior median eyes relatively large, set on low tubercles. Clypeus low, chelicerae with three teeth on promargin and four on retromargin. Sternum brown, labium and endites with slightly paler margins. Abdomen ovoid, brownish, with traces of darker chevrons posteriorly; dorsum sparsely covered with grey hairs. Venter with broad dark median stripe. Spinnerets short, dark. Legs long and slender, brown with lighter tarsi, first pair longest; tibiae I with dense, long, black, feathery hairs on ventral surface. Epigyne with narrow median septum (Fig. 176); gonopores placed anteriorly; seminal ducts straight; spermathecae large, spherical, strongly sclerotized, thick-walled (Fig. 177).

Material examined: SOUTH AFRICA: *Eastern Cape*: 6♂ 4♀ Coffee Bay, 31°58.862'S 29°09.119'E, coastal dune forest, beats, 2.xi.2006, R. Lyle & C. Haddad (NCA, 2007/408); 1♂ 1♀ Cwebbe Nature Reserve, The Haven, 32°14.497'S 28°54.653'E, hedges near houses, beats, 30.x.2006, C. Haddad (NCA, 2007/161); 1♀ same locality, 32°14.588'S 28°54.772'E, coastal dune forest, beats, 30.x.2006, R. Lyle & C. Haddad (NCA, 2007/354); 1♂ 1♀ Kei Mouth, 32°41'S 28°22'E, coastal dune forest, beats, 8.xii.2005, C. Haddad (NMBA); 3♂ 2♀ Mazeppa Bay, 32°28.476'S 28°38.873'E, coastal dune forest, beats, 28.x.2006, R. Lyle & C. Haddad (NCA, 2007/423). *KwaZulu-Natal*: 1♀ Tembe Elephant Park, open woodland/sand, near offices, 27°03'S 32°25'E, sweeping grass and herbs, 12.i.2002, C. Haddad (NCA, 2007/3559). *Mpumalanga*: 1♂ 1♀ Nelspruit, Schagen Farm, 25°25'S 30°48'E, macadamia orchards, branch beating, 9.xii.1997, M. van den Berg (NCA, 98/824); 1♀ same data but 17.iii.1998 (NCA, 98/873); 1♂ same locality, Glenwood Farm, 25°52'S 30°59'E, macadamia orchards, branch beating, 4.xii.1997, M. van den Berg (NCA, 98/825).

Distribution: Species known only from eastern South Africa (Fig. 178).

Habitat and biology: A foliage-dwelling species often collected in savanna and forests in subtropical eastern South Africa. As for other species of Spartaeinae, *V. durbani* is suspected to be arachnophagous, but has not yet been subjected to dietary analysis.

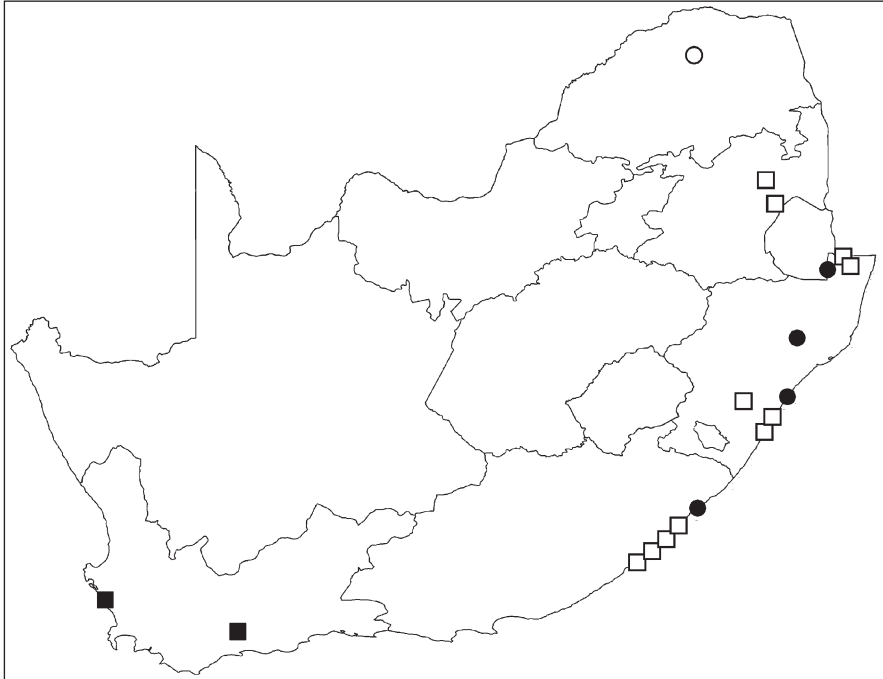

Fig. 178. Distribution of *Tomomingi szutsi* sp. n. (white circle), *Ureta quadrispinosa* (black circles), *Veissella durbani* (white squares) and *Xuriella prima* (black squares) in South Africa.

Genus *Xuriella* Wesolowska & Russell-Smith, 2000*Xuriella prima* Wesolowska & Russell-Smith, 2000

Xuriella prima: Wesolowska & Russell-Smith 2000: 115, figs 318–320; Wesolowska & Cumming 2008: 224, figs 196–204.

Wesolowska & Cumming (2008) described both sexes.

Material examined: SOUTH AFRICA: *Western Cape*: 1♂ Grootvadersbosch Forest Station, 20 km WSW of Heidelberg, 34°00'S 20°47'E, 1600 ft, indigenous forest, 8–10.xi.1985, C. Griswold, J. Doyen & T. Meikle-Griswold (NMSA, 26474); 1♀ Malmesburg, 33°24'S 18°16'E, on web under bark, 24.x.1987, L. Lotz (NMBA); 1♀ same locality, on web with imm. Sparassidae, 25.x.1987, L. Lotz (NMBA).

Distribution: Species known from Tanzania and Zimbabwe, recorded for the first time in South Africa (Fig. 178).

Habitat and biology: Previously known from equatorial and subtropical savanna habitats. Recorded here from Afromontane forest and fynbos habitats in south-western South Africa, where it is apparently a foliage-dwelling spider.

DISCUSSION

The current study has made a further contribution to our knowledge of the South African jumping spider fauna through the description of 19 new species and 12 new records for the country. It is clear that large areas of the country still need to be subjected to intensive sampling despite the recent efforts of the South African National Survey of Arachnida (SANSA) to resolve this.

Based on results of the present study, intensive sampling of an area, especially when using methods such as canopy fogging to collect the fauna from otherwise inaccessible habitat strata, can yield a considerable number of new species and provide invaluable distribution data, especially for rare taxa. As such, the SANSA and other research initiatives would benefit greatly in achieving their goals of determining arachnid biodiversity through the use of canopy fogging as a method, although it certainly is a much more labour intensive and costly exercise than more conventionally used and more easily implementable methods (beating, sweeping, pitfalls and litter sifting, *etc.*).

Of significance in the current study, but also taking into account other recently published taxonomic papers on southern African salticids (Wesolowska 2006, 2011; Wesolowska & Cumming 2008, 2011; Wesolowska & Haddad 2009; Haddad & Wesolowska 2011), is a very poor knowledge of the fauna of certain genera, for which two examples should be mentioned here. In the case of *Pseudicius*, these studies have together contributed to the increase of the fauna from nine to 23 species in southern Africa, of which 10 species have been described from South Africa alone. For *Rhene*, seven species have been described from southern Africa recently (six from South Africa alone), and *R. facilis* has also been recorded from South Africa for the first time here, more than doubling the number of species known from the region to 14.

The preliminary results would indicate that revisionary studies for many genera are likely to uncover a large proportion of new species, thanks largely to recently collected material. Efforts should thus be made to more thoroughly sample the fauna of previously poorly sampled areas, particularly in the western and southern parts of South Africa, to enhance the results of taxonomic studies and make an even greater contribution to understanding the biodiversity of South African jumping spiders.

ACKNOWLEDGEMENTS

This study was partially funded through a grant from the National Research Foundation of South Africa (NRF) in the Thuthuka programme (TTK2008050500003) to the second author. The curators of the various institutions are thanked for the loans of material that made this study possible, as well as for the rapid processing of deposited material. Galina Azarkina kindly provided some records of *Hasarius adansoni*, *Thylenula fidelis* and *Veissella durbani* for inclusion in this paper. Galina Azarkina and Dmitri Logunov are thanked for their constructive comments that helped improve this paper.

REFERENCES

- AUDOUIN, V. 1826. Explication sommaire des planches d'arachnides de l'Égypte et de la Syrie publiées par J. C. Savigny, membre de l'Institut; offrant un exposé des caractères naturels des genres avec la distinction des espèces. In: *Description de l'Égypte, ou Recueil des observations et des recherches qui ont été faites en Égypte pendant l'expédition de l'armée française*. T. 1, part. 4. Paris: Histoire Naturelle, pp. 99–186.
- AZARKINA, G.N. & LOGUNOV, D.V. 2010. New data on the jumping spiders of the subfamily Spartaeineae (Araneae: Salticidae) from Africa. *African Invertebrates* **51**: 163–182.
- BENJAMIN, S.P. 2004. Taxonomic revision and phylogenetic hypothesis for the jumping spider subfamily Ballinae (Araneae, Salticidae). *Zoological Journal of the Linnean Society* **142**: 1–82.
- BERLAND, L. & MILLOT, J. 1941. Les araignées de l'Afrique occidentale française. I. – Les Salticides. *Mémoires du Muséum National d'Histoire Naturelle (N.S.)* **12**: 297–424.
- BUTLER, A.G. 1876. Preliminary notice of new species of Arachnida and Myriopoda from Rodriguez, collected by Mssrs. George Gulliver and H.H. Slater. *The Annals and Magazine of Natural History, including Zoology, Botany, and Geology (4)* **17**: 439–446.
- 1879. Myriopoda and Arachnida. In: *An account of the petrological, botanical, and zoological collections made in Kerguelen's Land and Rodriguez during the Transit of Venus expedition, carried out by order of Her Majesty's Government in the years 1874–1875*. *Philosophical Transactions of the Royal Society of London* **168**: 497–509, pl. 52.
- CLARK, D.J. & BENOIT, P.L.G. 1977. Fam. Salticidae. In: *La faune terrestre de l'île de Sainte-Hélène*. Part IV. *Annales du Muséum Royal de l'Afrique Centrale, Sciences Zoologiques* **220**: 87–103.
- CUTLER, B. 1976. A catalogue of the jumping spiders of southern Africa (Araneae: Lyssomanidae and Salticidae). *Cimbebasia* **4**: 130–136.
- DENIS, J. 1955. Contribution à l'étude de l'Air (Mission L. Chopard et A. Villiers). Araignées. *Bulletin de l'Institut Français d'Afrique Noire* **17**: 99–146.
- GERSTÄCKER, A. 1873. Arachnoidea. In: von der Decken, C., ed., *Reisen in Ostafrika*. Bd 3, Teil 2. Leipzig & Heidelberg: Winter'sche, pp. 461–503.
- HADDAD, C.R. & WESOŁOWSKA, W. 2011. New species and new records of jumping spiders (Araneae: Salticidae) from central South Africa. *African Invertebrates* **52**: 51–134.
- LAWRENCE, R.F. 1928. Contributions to a knowledge of the fauna of South-West Africa VII. Arachnida (Part 2). *Annals of the South African Museum* **25**: 217–312, pls 21–24.
- 1937. A collection of Arachnida from Zululand. *Annals of the Natal Museum* **8**: 211–273, pl. 13.
- 1938. A collection of spiders from Natal and Zululand. *Annals of the Natal Museum* **8**: 455–524.
- 1942. A contribution to the araneid fauna of Natal and Zululand. *Annals of the Natal Museum* **10**: 141–190.
- 1947. A collection of Arachnida made by Dr. I. Trägårdh in Natal and Zululand (1904–1905). *Meddelanden från Göteborgs Musei Zoologiska Avdelning*. 116. *Göteborgs kungliga vetenskaps- och vitterhets-samhälles Handlingar, Ser. B* **5** (9): 1–41.
- LEDOUX, J.-C. 2007. Araignées de l'île de La Réunion: II. Salticidae. *Revue arachnologique* **17**: 9–34.
- LESSERT, R. DE. 1925. Araignées du Sud de l'Afrique. *Revue suisse de zoologie* **32**: 323–365.
- 1936. Araignées de l'Afrique orientale portugaise recueillies par M. P. Lesne at H.-B. Cott. *Revue suisse de zoologie* **43**: 207–306.
- LOGUNOV, D.V. 2000. A redefinition of the genera *Bianor* Peckham & Peckham, 1885 and *Harmochirus* Simon, 1885, with the establishment of a new genus *Sibianor* gen. n. *Arthropoda Selecta* **9**: 221–286.
- 2004. Taxonomic notes on a collection of jumping spiders from Sudan (Araneae, Salticidae). *Bulletin of the British Arachnological Society* **13**: 86–90.
- MADDISON, W.P. & NEEDHAM, K.M. 2006. Lapsiines and hisponines as phylogenetically basal salticid spiders (Araneae: Salticidae). *Zootaxa* **1255**: 37–55.
- MORAN, V.C. & SOUTHWOOD, T.R.E. 1982. The guild composition of arthropod communities in trees. *Journal of Animal Ecology* **51**: 289–306.
- PECKHAM, G.W. & PECKHAM, E.G. 1902. Some new genera and species of Attidae from South Africa. *Psyche* **9**: 330–335.

- 1903. New species of the family Attidae from South Africa. *Transactions of the Wisconsin Academy of Sciences, Arts and Letters* **14**: 173–278, pls 19–29.
- PLATNICK, N.I. 2012. *The World Spider Catalog*. Version 13.0. New York: American Museum of Natural History. (<http://research.amnh.org/iz/spiders/catalog>; accessed 11/07/2012)
- PRÓSZYŃSKI, J. 1987. *Atlas rysunków diagnostycznych mniej znanych Salticidae*. 2. Siedlce: Zeszyty Naukowe Wyższej Szkoły Rolniczo-Pedagogicznej.
- 1989. Salticidae (Araneae) of Saudi Arabia. *Fauna of Saudi Arabia* **10**: 31–64.
- 2012. *Monograph of the Salticidae (Araneae) of the World 1995–2011*. Version March 2012. (<http://www.gsd-salt.miiz.waw.pl/salticidae.php>; accessed 11/07/2012)
- PRÓSZYŃSKI, J. & DEELEMANN-REINHOLD, C.L. 2010. Description of some Salticidae (Araneae) from the Malay Archipelago. I. Salticidae of the Lesser Sunda Islands, with comments on related species. *Arthropoda Selecta* **19**: 153–188.
- PRÓSZYŃSKI, J. & ŻABKA, M. 1983. Genus *Tomocyrra* (Aranei, Salticidae) – hypothetic survivor of the amber fauna. Systematic study with description of four new species. *Acta zoologica cracoviensia* **26**: 563–578.
- SAARISTO, M.I. 1978. Spiders (Arachnida, Araneae) from the Seychelle islands, with notes on taxonomy. *Annales zoologici fennici* **15**: 99–126.
- 2010. Araneae. In: Gerlach, J. & Marusik, Y., eds, *Arachnida and Myriapoda of the Seychelles islands*. Manchester: Siri Scientific Press, pp. 8–306.
- SHORTHOUSE, D.P. 2010. *SimpleMappr, an online tool to produce publication-quality point maps*. (<http://www.simplemappr.net>; accessed 12/07/2012)
- SIMON, E. 1864. *Histoire naturelle des araignées (aranéides)*. Paris: Encyclopédique Roret.
- 1887. Arachnides recueillis dans le Sud de l’Afrique par Schinz. *Annales de la Société entomologique de France* **6**: 369–384.
- 1901. Etudes arachnologiques. 31^e memoire. L. Descriptions d’espèces nouvelles de la famille des Salticidae (suite). *Annales de la Société entomologique de France* **70**: 66–76.
- 1902. Description d’Arachnides nouveaux de la famille des Salticidae (Attidae) (suite). *Annales de la Société entomologique de Belgique* **46**: 24–56, 363–406.
- 1903. *Histoire naturelle des araignées*. T. 2, fasc. 4. Paris: Encyclopédique Roret, pp. 669–1080.
- 1910. Arachnoidea. Araneae. II. In: Schultze, L., ed., *Zoologische und anthropologische Ergebnisse einer Forschungsreise im westlichen und zentralen Südafrika*. *Denkschriften der medicinisch-naturwissenschaftlichen Gesellschaft zu Jena* **16**: 175–218.
- SZÜTS, T. & SCHARFF, N. 2009. Revision of the living members of the genus *Tomocyrra* Simon, 1900 (Araneae, Salticidae). *Contributions to Natural History* **12**: 1337–1372.
- VINSON, A. 1863. *Aranéides des îles de la Réunion, Maurice et Madagascar*. Paris: Encyclopédique Roret.
- WANLESS, F.R. 1978. A revision of the spider genus *Portia* (Araneae: Salticidae). *Bulletin of the British Museum (Natural History), Zoology Series* **34**: 83–124.
- 1980. A revision of the spider genera *Asemonea* and *Pandisus* (Araneae: Salticidae). *Bulletin of the British Museum (Natural History), Zoology Series* **39**: 213–257.
- 1984a. Araneae-Salticidae. Contributions à l’étude de la faune terrestre des îles granitiques de l’archipel des Séchelles (Mission P.L.G. Benoit - J.J. Van Mol 1972). *Annales du Musée Royal de l’Afrique Centrale, Sciences Zoologiques* **241**: 1–84.
- 1984b. A review of the spider subfamily Spartaeninae nom. n. (Araneae: Salticidae) with descriptions of six new genera. *Bulletin of the British Museum (Natural History), Zoology Series* **46**: 135–205.
- WESOŁOWSKA, W. 1986. A revision of the genus *Heliophanus* C.L. Koch, 1833 (Aranei: Salticidae). *Annales zoologici* **40**: 1–254.
- 1993. A revision of the spider genus *Massagris* Simon, 1900 (Araneae, Salticidae). *Genus* **4**: 133–141.
- 1999. New and little known species of jumping spiders from Zimbabwe (Araneae: Salticidae). *Arnoldia Zimbabwe* **10**: 145–174.
- 2001. New and rare species of the genus *Asemonea* O. P.-Cambridge, 1869 from Kenya (Araneae: Salticidae). *Genus* **12**: 577–584.
- 2003. A redescription of *Mogrus mathisi* (Berland et Millot, 1941) and its synonyms (Araneae: Salticidae). *Genus* **14**: 425–430.
- 2004. A redescription of *Heliophanus pygmaeus* Wesolowska et Russell-Smith, 2000, a small beetle-like salticid from Africa (Araneae: Salticidae). *Genus* **15**: 275–280.
- 2006. Jumping spiders from the Brandberg massif in Namibia (Araneae: Salticidae). *African Entomology* **14**: 225–256.
- 2011. New species and new records of jumping spiders from Botswana, Namibia and Zimbabwe (Araneae: Salticidae). *Genus* **22**: 307–346.

- WESOŁOWSKA, W. & CUMMING, M.S. 2008. Taxonomy and natural history of a species rich assemblage of jumping spiders (Araneae, Salticidae): a long-term study of a suburban site in Zimbabwe. *Annales zoologici* **58**: 167–230.
- 2011. New species and records of jumping spiders (Araneae, Salticidae) from Sengwa Wildlife Research Area in Zimbabwe. *Journal of Afrotropical Zoology* **7**: 75–104.
- WESOŁOWSKA, W. & EDWARDS, G.B. 2012. Jumping spiders (Araneae: Salticidae) of the Calabar area (SE Nigeria). *Annales zoologici* **62**: 733–772.
- WESOŁOWSKA, W. & HADDAD, C.R. 2009. Jumping spiders (Araneae: Salticidae) of the Ndumo Game Reserve, Maputaland, South Africa. *African Invertebrates* **50**: 13–103.
- WESOŁOWSKA, W. & RUSSELL-SMITH, A. 2000. Jumping spiders from Mkomazi Game Reserve in Tanzania (Araneae: Salticidae). *Tropical Zoology* **13**: 11–127.
- 2011. Jumping spiders (Araneae: Salticidae) from southern Nigeria. *Annales zoologici* **61**: 553–619.
- WESOŁOWSKA, W. & TOMASIEWICZ, B. 2008. New species and records of Ethiopian jumping spiders (Araneae, Salticidae). *Journal of Afrotropical Zoology* **4**: 3–59.
- WESOŁOWSKA, W. & VAN HARTEN, A. 1994. *The jumping spiders (Salticidae, Araneae) of the Yemen*. Yemeni-German Plant Protection Project. Sana'a: Horizons Printing & Publishing.
- 2007. Additions to the knowledge of the jumping spiders (Araneae: Salticidae) of Yemen. *Fauna of Arabia* **23**: 189–269.